

**Adda247**  
**Maharashtra**  
Ultimate Companion to Ace the Exam

# **SSC CHSL TIER 1 PYP**

**English**

## **All Shifts Answer key**

## Table of Contents

<a href="#">01/07/2024,   9:00 AM - 10:00 AM     Click Here</a>	3
<a href="#">01/07/2024,   11:45 AM - 12:45 PM     Click Here</a>	22
<a href="#">01/07/2024,   2:30 PM - 3:30 PM     Click Here</a>	43
<a href="#">01/07/2024,   5:15 PM - 6:15 PM     Click Here</a>	63
<a href="#">02/07/2024,   9:00 AM - 10:00 AM     Click Here</a>	85
<a href="#">02/07/2024,   11:45 AM - 12:45 PM     Click Here</a>	109
<a href="#">02/07/2024,   2:30 PM - 3:30 PM     Click Here</a>	131
<a href="#">02/07/2024,   5:15 PM - 6:15 PM     Click Here</a>	153
<a href="#">03/07/2024,   9:00 AM - 10:00 AM     Click Here</a>	174
<a href="#">03/07/2024,   11:45 AM - 12:45 PM     Click Here</a>	193
<a href="#">03/07/2024,   2:30 PM - 3:30 PM     Click Here</a>	215
<a href="#">03/07/2024,   5:15 PM - 6:15 PM     Click Here</a>	236
<a href="#">04/07/2024,   9:00 AM - 10:00 AM     Click Here</a>	258
<a href="#">04/07/2024,   11:45 AM - 12:45 PM     Click Here</a>	279
<a href="#">04/07/2024,   2:30 PM - 3:30 PM     Click Here</a>	302
<a href="#">04/07/2024,   5:15 PM - 6:15 PM     Click Here</a>	323
<a href="#">05/07/2024,   9:00 AM - 10:00 AM     Click Here</a>	345
<a href="#">05/07/2024,   11:45 AM - 12:45 PM     Click Here</a>	367
<a href="#">05/07/2024,   2:30 PM - 3:30 PM     Click Here</a>	387
<a href="#">05/07/2024,   5:15 PM - 6:15 PM     Click Here</a>	409
<a href="#">08/07/2024,   9:00 AM - 10:00 AM     Click Here</a>	429
<a href="#">08/07/2024,   11:45 AM - 12:45 PM     Click Here</a>	450
<a href="#">08/07/2024,   2:30 PM - 3:30 PM     Click Here</a>	471
<a href="#">08/07/2024,   5:15 PM - 6:15 PM     Click Here</a>	491
<a href="#">09/07/2024,   9:00 AM - 10:00 AM     Click Here</a>	512
<a href="#">09/07/2024,   11:45 AM - 12:45 PM     Click Here</a>	533
<a href="#">09/07/2024,   2:30 PM - 3:30 PM     Click Here</a>	554

<a href="#">09/07/2024,   5:15 PM - 6:15 PM   Click Here</a>	577
<a href="#">10/07/2024,   9:00 AM - 10:00 AM   Click Here</a>	598
<a href="#">10/07/2024,   11:45 AM - 12:45 PM   Click Here</a>	620
<a href="#">10/07/2024,   2:30 PM - 3:30 PM   Click Here</a>	641
<a href="#">10/07/2024,   5:15 PM - 6:15 PM   Click Here</a>	664
<a href="#">11/07/2024,   9:00 AM - 10:00 AM   Click Here</a>	685
<a href="#">11/07/2024,   11:45 AM - 12:45 PM   Click Here</a>	707
<a href="#">11/07/2024,   2:30 PM - 3:30 PM   Click Here</a>	729
<a href="#">11/07/2024,   5:15 PM - 6:15 PM   Click Here</a>	752

Adda247 Marathi

## Combined Higher Secondary Level Examination 2024 Tier I

Exam Date	01/07/2024
Exam Time	9:00 AM - 10:00 AM
Subject	CHSL Exam 2024 Tier I

### Section : English Language

1. The following sentence has been divided into four segments. Identify the segment that contains a grammatical error.

Passengers started behaving / violent when / they were asked / to leave the bus station.

- Ans
- 1. to leave the bus station.
  - 2. Passengers started behaving
  - 3. violent when
  - 4. they were asked

2. The following sentence has been split into four segments. Identify the segment that contains a grammatical error. The couple / preferred to walk / until the last house / of the town.

- Ans
- 1. The couple
  - 2. preferred to walk
  - 3. of the town
  - 4. until the last house

3. Select the sentence in the future tense.

- Ans
- 1. I will be twenty five next Sunday.
  - 2. I have been twenty five next Sunday.
  - 3. I should be twenty five next Sunday.
  - 4. I could be twenty five next Sunday.

Q.4 The underlined phrase in the given sentence has been used incorrectly. Select the option that can correctly replace the underlined segment.

I am down with her complaints.

- Ans
- 1. passed out with
  - 2. fed up with
  - 3. held down with
  - 4. looked down with

**Comprehension:**

In the following passage, some words have been deleted. Read the passage carefully and select the most appropriate option to fill in each blank.

As Paul was (1) \_\_\_\_\_ his supper, Aunt Jenny (2) \_\_\_\_\_ him questions that have been full of deceit , and had a very deep meaning, for she wanted to trap him. It seemed as if she was endowed with a (3) \_\_\_\_\_ which could hunt for dark and mysterious tact.

She asked, "Did you now not want to swim, Paul?"

Paul felt an uncomfortable (4) \_\_\_\_\_.

He (5) \_\_\_\_\_ Aunt Jennys face; however it informed him nothing. So, he said, "No, ma'am."

**SubQuestion No : 5****Q.5** Select the most appropriate option to fill in blank no. 1.

- Ans**
- 1. eating
  - 2. churning
  - 3. feeding
  - 4. grazing

**Comprehension:**

In the following passage, some words have been deleted. Read the passage carefully and select the most appropriate option to fill in each blank.

As Paul was (1) \_\_\_\_\_ his supper, Aunt Jenny (2) \_\_\_\_\_ him questions that have been full of deceit , and had a very deep meaning, for she wanted to trap him. It seemed as if she was endowed with a (3) \_\_\_\_\_ which could hunt for dark and mysterious tact.

She asked, "Did you now not want to swim, Paul?"

Paul felt an uncomfortable (4) \_\_\_\_\_.

He (5) \_\_\_\_\_ Aunt Jennys face; however it informed him nothing. So, he said, "No, ma'am."

**SubQuestion No : 6****Q.6** Select the most appropriate option to fill in blank no. 2.

- Ans**
- 1. demanded
  - 2. allowed
  - 3. submitted
  - 4. asked

**Comprehension:**

In the following passage, some words have been deleted. Read the passage carefully and select the most appropriate option to fill in each blank.

As Paul was (1) \_\_\_\_\_ his supper, Aunt Jenny (2) \_\_\_\_\_ him questions that have been full of deceit , and had a very deep meaning, for she wanted to trap him. It seemed as if she was endowed with a (3) \_\_\_\_\_ which could hunt for dark and mysterious tact.

She asked, "Did you now not want to swim, Paul?"

Paul felt an uncomfortable (4) \_\_\_\_\_.

He (5) \_\_\_\_\_ Aunt Jennys face; however it informed him nothing. So, he said, "No, ma'am."

**SubQuestion No : 7****Q.7** Select the most appropriate option to fill in blank no. 3.

- Ans**
- 1. technique
  - 2. purpose
  - 3. talent
  - 4. weakness

**Comprehension:**

In the following passage, some words have been deleted. Read the passage carefully and select the most appropriate option to fill in each blank.

As Paul was (1) \_\_\_\_\_ his supper, Aunt Jenny (2) \_\_\_\_\_ him questions that have been full of deceit , and had a very deep meaning, for she wanted to trap him. It seemed as if she was endowed with a (3) \_\_\_\_\_ which could hunt for dark and mysterious tact.

She asked, "Did you now not want to swim, Paul?"

Paul felt an uncomfortable (4) \_\_\_\_\_.

He (5) \_\_\_\_\_ Aunt Jennys face; however it informed him nothing. So, he said, "No, ma'am."

**SubQuestion No : 8**

**Q.8 Select the most appropriate option to fill in blank no. 4.**

- Ans
- 1. drop
  - 2. suspicion
  - 3. view
  - 4. guess

**Comprehension:**

In the following passage, some words have been deleted. Read the passage carefully and select the most appropriate option to fill in each blank.

As Paul was (1) \_\_\_\_\_ his supper, Aunt Jenny (2) \_\_\_\_\_ him questions that have been full of deceit , and had a very deep meaning, for she wanted to trap him. It seemed as if she was endowed with a (3) \_\_\_\_\_ which could hunt for dark and mysterious tact.

She asked, "Did you now not want to swim, Paul?"

Paul felt an uncomfortable (4) \_\_\_\_\_.

He (5) \_\_\_\_\_ Aunt Jennys face; however it informed him nothing. So, he said, "No, ma'am."

**SubQuestion No : 9**

**Q.9 Select the most appropriate option to fill in blank no. 5.**

- Ans
- 1. chased
  - 2. ruffled
  - 3. searched
  - 4. pursued

**Q.10 Select the most appropriate option that can substitute the underlined segment in the given sentence.**

This is best book for children to read.

- Ans
- 1. This is the best book
  - 2. This is good book
  - 3. This is very good book
  - 4. This is very best book

**Q.11 Select the most appropriate meaning of the underlined idiom.**

The realtors of the new venture sold plots like hot cakes.

- Ans
- 1. Sold innovatively
  - 2. Sold quickly and in large numbers
  - 3. Sold illegally
  - 4. Sold with great difficulty

**Q.12 Select the most appropriate meaning of the given idiom.**

**Black and white**

- Ans
- 1. In dispute
  - 2. A false invention
  - 3. In writing
  - 4. Doubtful

Q.13 Select the most appropriate ANTONYM of the given word.  
Glory

- Ans
- 1. Shame
  - 2. Honour
  - 3. Delight
  - 4. Gluttony

Q.14 Select the most appropriate option that can substitute the underlined segment in the given sentence.

The skunk had a conspicuous spinal stripe.

- Ans
- 1. obscure
  - 2. charming
  - 3. noticeable
  - 4. faint

Q.15 Select the most appropriate ANTONYM of the underlined word.  
Would you please support me for once in your life?

- Ans
- 1. establish
  - 2. refute
  - 3. document
  - 4. disclaim

Q.16 Select the most appropriate ANTONYM of the given word .  
Trivial

- Ans
- 1. Vain
  - 2. Essential
  - 3. Liable
  - 4. Lavish

Q.17 Select the INCORRECTLY spelt word.

- Ans
- 1. Encraoch
  - 2. Delegate
  - 3. Illusion
  - 4. Obtain

Q.18 Select the most appropriate option that can substitute the underlined segment in the given sentence.  
Rahul had strong pain in his stomach.

- Ans
- 1. severe
  - 2. high
  - 3. deep
  - 4. strict

Q.19 Select the most appropriate ANTONYM of the underlined word in the given sentence.  
How can you be so joyless on hearing the news?

- Ans
- 1. Beaming
  - 2. Rapt
  - 3. Blissful
  - 4. Dubious

Q.20 Select the most appropriate option to fill in the blank.

In both countries we have leaders of \_\_\_\_\_ ability.

- Ans
- 1. powerful
  - 2. almighty
  - 3. compelling
  - 4. exceptional

Q.21 The following sentence has been split into four segments. Identify the segment that contains a spelling error. I begged him / to reconsider / the decision but / he refused to yield.

- Ans
- 1. the decision but
  - 2. I begged him
  - 3. he refused to yield.
  - 4. to reconsider

Q.22 Select the most appropriate option that can substitute the underlined words in the given sentence.

It is a general belief that the female ostrich guard the nest at night.

- Ans
- 1. guarded the nest at night
  - 2. guards the nest at night
  - 3. does guard the nest in night
  - 4. is guarding the nest at night

Q.23 Select the most appropriate option to fill in the blank.

Yesterday, I ate only a \_\_\_\_\_ of apples for my dinner.

- Ans
- 1. pair
  - 2. pier
  - 3. pare
  - 4. pear

Q.24 Select the most appropriate synonym of the bracketed word in the following sentence to fill in the blank.

The documentary explored the historical and cultural significance of the \_\_\_\_\_ (antique) ruins in the region.

- Ans
- 1. obsolete
  - 2. contemporary
  - 3. modern
  - 4. ancient

Q.25 Select the most appropriate option that can substitute the underlined segment in the given sentence. If there is no need to substitute it, select 'No substitution required'.

The little boy cried with pain when he burnt his fingers.

- Ans
- 1. No substitution required
  - 2. when he burns his fingers
  - 3. while he burn his fingers
  - 4. as he burning his fingers



Q.1 Select the set in which the numbers are related in the same way as are the numbers of the following sets.  
 (NOTE: Operations should be performed on the whole numbers, without breaking down the numbers into its constituent digits. E.g., 13 – Operations on 13 such as adding/deleting/multiplying etc. to 13 can be performed. Breaking down 13 into 1 and 3 and then performing mathematical operations on 1 and 3 is not allowed.)  
 (10, 5, 20)  
 (14, 7, 28)

- Ans
- 1. (48, 24, 58)
  - 2. (33, 11, 44)
  - 3. (22, 11, 44)
  - 4. (54, 18, 72)

Q.2 Identify the figure given in the options that when put in place of the question mark (?) will logically complete the series.

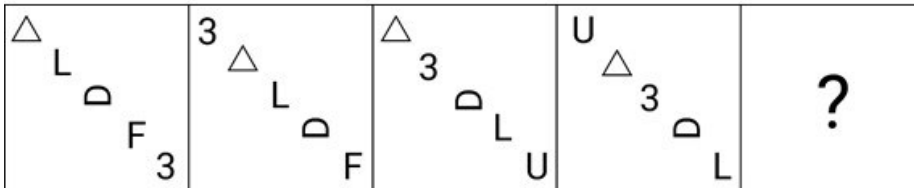

Ans

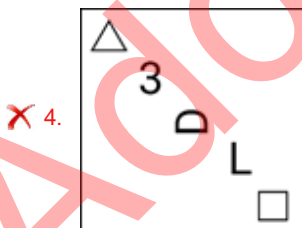
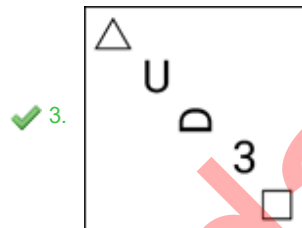
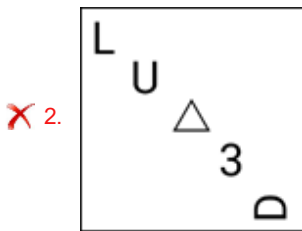
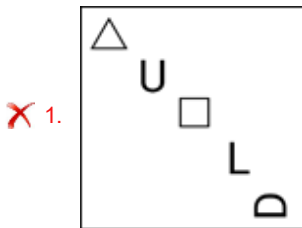

Q.3 Select the correct mirror image of the given figure when the mirror is placed at MN as shown below.

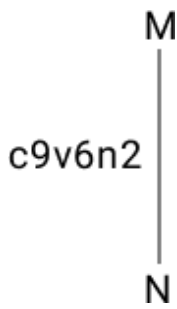

- Ans
- 1.  $\Sigma n \partial v \theta \sigma$
  - 2.  $\Sigma u \theta \Lambda \theta \sigma$
  - 3. c9v6n2
  - 4.  $c \partial \Lambda \theta \theta \Sigma$

Q.4 Select the combination of letters that when sequentially placed in the blanks of the given series will logically complete the series.

A \_ A \_ C A B \_ B \_ A \_ \_ B C A B A \_ C

- Ans
- 1. BBACABB
  - 2. BBABBCB
  - 3. BBACBAB
  - 4. BABACBA

Q.5 LBXF is related to SYCM in a certain way based on the English alphabetical order. In the same way, TGFY is related to AGHF. To which of the following is ZDMK related, following the same logic?

- Ans
- 1. GRNE
  - 2. GREN
  - 3. GNER
  - 4. GNRE

Q.6 If 'U' stands for '+', 'D' stands for 'x', 'B' stands for '+' and 'T' stands for '-', what will come in place of the question mark (?) in the following equation?  
 $13 T 26 U 13 D 24 B 7 = ?$

- Ans
- 1. -56
  - 2. -87
  - 3. -43
  - 4. -28

Q.7 What should come in place of the question mark (?) in the given series?

129, 128, 124, 115, 99, ?

- Ans
- 1. 73
  - 2. 71
  - 3. 74
  - 4. 72

Q.8 The position of how many letters will remain unchanged if each of the letters in the word 'VIRTUAL' is arranged in English alphabetical order?

- Ans
- 1. None
  - 2. One
  - 3. Three
  - 4. More than three

Q.9 Which two numbers should be interchanged to make the given equation correct?

$$74 - 52 + (39 \div 13) \times 16 + (14 \div 2) = 106$$

(NOTE: Numbers must be interchanged and not the constituent digits e.g. if 2 and 3 are to be interchanged in the equation  $43 \times 3 + 4 \div 2$ , then interchanged equation is  $43 \times 2 + 4 \div 3$ )

- Ans
- 1. 52 and 39
  - 2. 74 and 52
  - 3. 14 and 52
  - 4. 14 and 16

Q.10 If the year is NOT a leap year, then how is the last day of the year and first day of the same year related?

- Ans
- 1. First day is Sunday, last day is Friday
  - 2. First day is Sunday, last day is Saturday
  - 3. First day is Tuesday, last day is Saturday
  - 4. They are the same.

Q.11 What should come in place of ? in the given series based on the English alphabetical order?

FNV LUE ? XIW DPF

- Ans
- 1. GQZ
  - 2. UWZ
  - 3. HRY
  - 4. RBN

Q.12 What would be the letter on the opposite side of 'Y' if the given sheet is folded to form a cube?

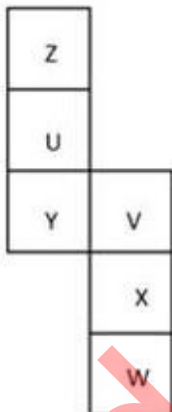

- Ans
- 1. Z
  - 2. V
  - 3. W
  - 4. X

Q.13 Six numbers 1, 3, 5, 6, 7 and 8 are written on different faces of a dice. Two positions of this dice are shown in the figure. Which is the number on the face opposite to the face containing 6?

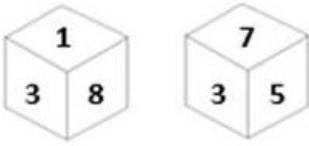

- Ans
- 1. 5
  - 2. 7
  - 3. 3
  - 4. 8

Q.14 96 is related to 16 following a certain logic. Following the same logic, 156 is related to 26. To which of the following is related 228 following the same logic?  
(NOTE : Operations should be performed on the whole numbers, without breaking down the numbers into its constituent digits. E.g. 13 – Operations on 13 such as adding /deleting /multiplying etc., to 13 can be performed. Breaking down 13 into 1 and 3 and then performing mathematical operations on 1 and 3 is not allowed.)

- Ans
- 1. 42
  - 2. 34
  - 3. 38
  - 4. 36

Q.15 What should come in place of the question mark (?) in the given series?

40 ? 18 10 4 0

- Ans
- 1. 22
  - 2. 25
  - 3. 30
  - 4. 28

Q.16 'A + B' means 'A is the brother of B'.  
'A - B' means 'A is the wife of B'.  
'A × B' means 'A is the father of B'.  
'A ÷ B' means 'A is the sister of B'.  
In 'T × X ÷ Y + Z', how is T related to Z using the same meaning of the mathematical operators as given above?

- Ans
- 1. Father
  - 2. Daughter
  - 3. Father-in-law
  - 4. Brother

Q.17 What will come in the place of the question mark (?) in the following equation, if '+' and '-' are interchanged and '×' and '÷' are interchanged?

$$162 \times 9 - 452 + 7 \div 9 = ?$$

- Ans
- 1. 707
  - 2. 407
  - 3. 507
  - 4. 607

Q.18 Select the pair which follows the same pattern as that followed by the two set of pairs given below. Both pairs follow the same pattern.

DFG : IKL

MOP : RTU

- Ans
- 1. WYZ : GIJ
  - 2. FHI : EGH
  - 3. TVW : YAB
  - 4. PST : KHG

Q.19 Read the given statements and conclusions carefully. Assuming that the information given in the statements is true, even if it appears to be at variance with commonly known facts, decide which of the given conclusions logically follow(s) from the statements.

Statements:

Some keys are chains.

All chains are locks.

No lock is a rock.

Conclusions:

(I) No rock is a key.

(II) At least some keys are locks.

- Ans
- 1. None of the conclusion follow
  - 2. Both conclusions I and II follow
  - 3. Only conclusion II follows
  - 4. Only conclusion I follows

Q.20 Three of the following four are alike in a certain way and thus form a group. Which is the one that does NOT belong to that group?

(Note: The odd one out is not based on the number of consonants/vowels or their position in the letter cluster.)

- Ans
- 1. AJQ
  - 2. MVC
  - 3. OXC
  - 4. ENU

Q.21 How many triangles are there in the given figure?

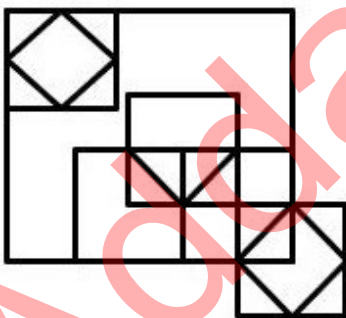

- Ans
- 1. 15
  - 2. 13
  - 3. 14
  - 4. 11

Q.22 Select the correct mirror image of the given figure when the mirror is placed at MN as shown below.

**R T Y Z X C 5 7**

M \_\_\_\_\_ N

Ans

1. **B T Y Z X C 5 7**

2. **B T Y Z X C 5 7**

3. **B T Z Y X C 5 7**

4. **R T Y Z X C 5 7**

Q.23 In a certain code language, BEAM is coded as 2349 and MEAN is coded as 4327. What is the code for N in that language?

Ans

1. 3

2. 7

3. 4

4. 2

Q.24 In a certain code language, 'strong and mighty' is written as 'ui yv tk' and 'soft yet strong' is written as 'hd tk bw'. How is 'strong' written in the given language?

Ans

1. hd

2. bw

3. ui

4. tk

Q.25 What would be the symbol on the opposite side of '≠' if the given sheet is folded to form a cube?

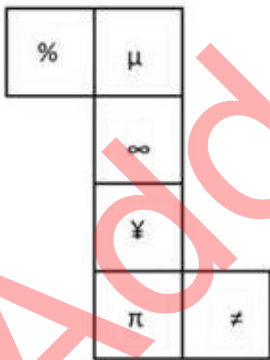

Ans

1. **¥**

2. **∞**

3. **%**

4. **μ**

Q.1 If Arun's salary was decreased by 50% and subsequently increased by 50%, then how much per cent did he lose?

- Ans
- 1. 25%
  - 2. 40%
  - 3. 10%
  - 4. 36%

Q.2 Simplify the following expression.

$$3 + 28 \div 35 \times 15 + 4 - 3 \times 4$$

- Ans
- 1. 10
  - 2. 26
  - 3. 64
  - 4. 7

Q.3 A motorcycle covered the first 60 km of its journey at an average speed of 40 km/h. The speed of the motorcycle for covering the rest of the journey, i.e. 90 km, was 45 km/h. During the whole journey, the overall average speed of the motorcycle was:

- Ans
- 1. 42 km/h
  - 2.  $42\frac{1}{2}$  km/h
  - 3.  $42\frac{1}{7}$  km/h
  - 4.  $42\frac{6}{7}$  km/h

Q.4 A shopkeeper decides to raise the marked price of an article by 40%. How much percentage discount should he allow to be able to sell the article at the original marked price?

- Ans
- 1.  $26\frac{3}{7}\%$
  - 2.  $24\frac{3}{7}\%$
  - 3.  $31\frac{2}{7}\%$
  - 4.  $28\frac{4}{7}\%$

Q.5 A largest possible sphere is carved from a cube of side 14 cm. What is its volume in  $\text{cm}^3$ ?

- Ans
- 1.  $1600\frac{1}{3}$
  - 2.  $1437\frac{1}{3}$
  - 3.  $205\frac{1}{3}$
  - 4.  $1707\frac{1}{3}$

Q.6 A and B can do a work in 10 days and 40 days, respectively. How long will it take together to complete the work?

- Ans
- 1. 12 days
  - 2. 8 days
  - 3. 15 days
  - 4. 20 days

Q.7 A company has five plants for manufacturing spare parts. Each plant manufactures local quality and export quality. What is the ratio of the production of local quality and export quality units of the highest manufacturing plant?

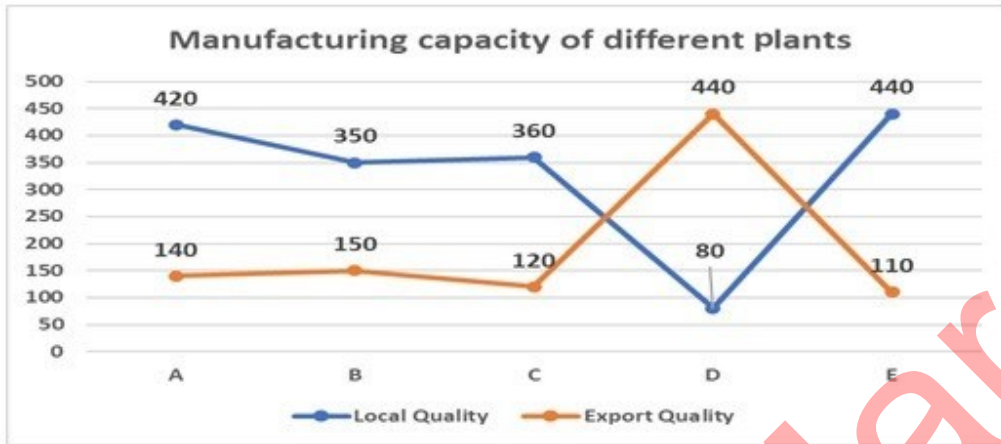

- Ans
- 1. 2 : 11
  - 2. 4 : 1
  - 3. 3 : 1
  - 4. 7 : 3

Q.8 Which of the following is a correct statement?

- Ans
- 1. The sum of the angles of a cyclic quadrilateral is always  $180^\circ$ .
  - 2. Equal chords are equidistant from the centre of the circle but not always subtend equal angle at centre of the circle
  - 3. If two circles touch each other, the point of contact lies on the line joining the two centres.
  - 4. Angles subtended by the arc in the same segment of the circle are in ratio of 2 : 1.

Q.9 Radhika requested the cashier of a bank to get her coins in lieu of her cheque worth ₹1,845. Cashier gave her a packet containing ₹5, ₹10 and ₹20 coins in the ratio of 3 : 5 : 7. What is the total worth of the smallest coin received by her?

- Ans
- 1. ₹125
  - 2. ₹105
  - 3. ₹145
  - 4. ₹135



Q.10

The percentage of students enrolled in different activities in a school which are displayed in the left side pie chart. The total number of students is 5000.

In the right-side pie chart, the total number of girls is 1550 and their percentage breakup enrolled in these activities.

**Total Students Enrolled**

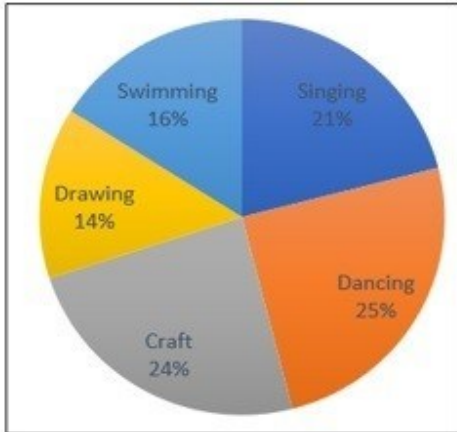

**Girls Enrolled**

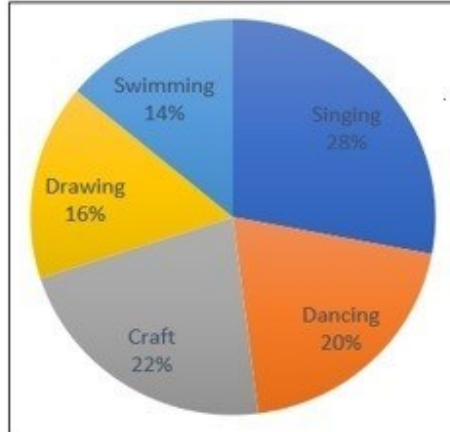

The number of girls enrolled in Craft forms what per cent of the total number of students in the school?

- Ans
- 1. 6.82%
  - 2. 5.81%
  - 3. 5.82%
  - 4. 7.11%

Q.11

In how many years will the simple interest on a sum of money be equal to the principal at the rate of  $2\frac{6}{7}\%$  per annum?

- Ans
- 1. 35 years
  - 2. 34 years
  - 3. 33 years
  - 4. 37 years

Q.12

Given that the perimeters of two similar triangles,  $\triangle ABC$  and  $\triangle DEF$ , are 24 cm and 9 cm, respectively, and  $DE = 3$  cm, what is the ratio between the area of  $\triangle ABC$  and that of  $\triangle DEF$ ?

- Ans
- 1. 64 : 9
  - 2. 54 : 9
  - 3. 64 : 7
  - 4. 54 : 7

Q.13

A man spent 60% of his salary on household expenses, 20% of his salary on rent and out of remaining salary, he donated 80% to a trust. If he is left with ₹20,000, then what is his salary?

- Ans
- 1. ₹4,00,000
  - 2. ₹5,00,000
  - 3. ₹5,50,000
  - 4. ₹50,000

Q.14 A shopkeeper marks up the price of the oil by 40% and uses a faulty machine which measures 15% less. If the shopkeeper gives a discount of 32%, the profit/loss percentage is:

- Ans
- 1. 15% Loss
  - 2. 25% Profit
  - 3. 18% Loss
  - 4. 12% Profit

Q.15 If equation of line p is  $x + y = 5$  and that of line q is  $x - y = 3$ , what are the coordinates of the point common to both the lines?

- Ans
- 1. (2, 1)
  - 2. (2, 3)
  - 3. (4, 1)
  - 4. (1, 4)

Q.16 Study the given pie-charts and answer the question that follows.

The pie-charts show the data of students' progress after graduation.

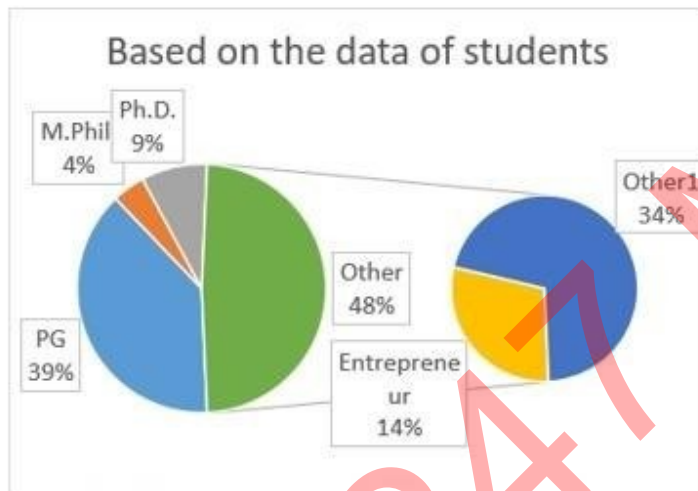

Which two combined have the same number of students as the other?

- Ans
- 1. P.G. + M.Phil.
  - 2. Entrepreneur + Ph.D.
  - 3. Entrepreneur + P.G.
  - 4. P.G. + Ph.D.

Q.17 What will be the least value of x so that the 5-digit number 627x5 becomes divisible by 9?

- Ans
- 1. 7
  - 2. 4
  - 3. 3
  - 4. 9

Q.18 The ratio of the diameters of two spheres is given as 1 : 4. The larger sphere is melted and 125 identical spheres are made out of the molten material. The smaller sphere is melted and 27 identical spheres are made out of the molten material. If the ratio of the volume of each of the 125 identical spheres to the volume of each of the 27 identical spheres is given as 1 : m, what is the value of m?

- Ans
- 1.  $\frac{1728}{125}$
  - 2.  $\frac{27}{8000}$
  - 3.  $\frac{125}{1728}$
  - 4.  $\frac{64}{3375}$

Q.19 If PQ and PR are the two tangents to a circle with center O, and  $\angle QOR=150^\circ$ , then  $\angle QPR$  is equal to:

- Ans
- 1.  $60^\circ$
  - 2.  $30^\circ$
  - 3.  $90^\circ$
  - 4.  $45^\circ$

Q.20 A man walking at the speed of 5 km/h covers a certain distance in 3 hours 45 minutes. If he covers the same distance by a cycle in 2 hours 10 minutes, then the speed of the cycle in km/h is:

- Ans
- 1.  $7\frac{16}{26}$
  - 2.  $9\frac{11}{26}$
  - 3.  $8\frac{17}{26}$
  - 4.  $5\frac{11}{26}$

Q.21 Two parallel chords on the same side of the centre of a circle are 12 cm and 20 cm long and the radius of the circle is  $5\sqrt{13}$  cm. What is the distance between the chords?

- Ans
- 1. 3 cm
  - 2. 5 cm
  - 3. 2 cm
  - 4. 4 cm

Q.22 The surface area of a cube is  $486\text{ cm}^2$  Find the volume.

- Ans
- 1.  $486\text{ cm}^3$
  - 2.  $729\text{ cm}^3$
  - 3.  $625\text{ cm}^3$
  - 4.  $512\text{ cm}^3$

Q.23 In right-angled triangle ABC,  $\angle B = 90^\circ$  and angle A and angle C are acute angles. If  $\operatorname{cosec} A = 2\sqrt{2}$ , then find the value of  $\sin A \cdot \cos C + \cos A \cdot \sin C$ .

- Ans
- 1. 0
  - 2.  $2\sqrt{2}$
  - 3. 1
  - 4.  $\sqrt{2}$

Q.24 Mohan gets 12% increase in his sale amount in the first year and 15% increase in the second year, with that his present sale is ₹1,28,800. What was his sale two years ago?

- Ans
- 1. ₹1,25,000
  - 2. ₹1,50,000
  - 3. ₹1,75,000
  - 4. ₹1,00,000

Q.25 The given table shows the percentage of marks obtained by 5 students in different subjects. Study the table and answer the question that follows. (Maximum marks are given beside subject)

Subjects →	Physics	Maths	Music	Hindi	Botany
Students ↓	300	300	100	100	200
Ram	60	80	90	60	95
Shyam	90	70	80	70	40
Sohan	70	90	95	80	75
Mohan	80	60	70	95	80
Karn	90	50	85	85	80

What are the marks (in percentage) obtained by Mohan?

- Ans
- 1. 77.5%
  - 2. 76.5%
  - 3. 74.5%
  - 4. 75.5%

Section : General Awareness

1. Average function is listed in the drop-down menu of which of the following tools?

- Ans
- 1. Financial function
  - 2. Auto Sum function
  - 3. Move function
  - 4. Insert function

2. Where can you find the emoticons in an instant messaging conversation window?

- Ans
- 1. At the middle of the chat window
  - 2. Any where in the chat window
  - 3. At the bottom of the chat window
  - 4. At the top of the chat window

3. Who has the power to regulate the right of citizenship in India?

- Ans
- 1. Supreme Court
  - 2. President
  - 3. Governor
  - 4. Parliament

Q.4 In which year has India hosted the Asian Games for the first time?

- Ans
- 1. 1948
  - 2. 1951
  - 3. 1950
  - 4. 1949

Q.5 Who among the following was the author of 'Brihat Katha Kosh'?

- Ans
- 1. Dandin
  - 2. Harisena
  - 3. Kshemendra
  - 4. Bhavabhuti

Q.6 Langvir Nritya is a folk dance from the state of \_\_\_\_\_.

- Ans
- 1. Haryana
  - 2. Gujarat
  - 3. Uttar Pradesh
  - 4. Uttarakhand

Q.7 Geoid is the \_\_\_\_\_ of earth.

- Ans
- 1. shape
  - 2. axis
  - 3. colour
  - 4. orbit

Q.8 In the context of DNA, which of the following principles governs the process of transcription?

- Ans
- 1. The transforming principle
  - 2. The principle of complementarity
  - 3. Semiconservative nature of DNA
  - 4. The principle of inheritance

Q.9 With which of the following states is the Bhatiali folk music, which is mostly sung by the fishermen, associated?

- Ans
- 1. West Bengal
  - 2. Odisha
  - 3. Andhra Pradesh
  - 4. Kerala

Q.10 Who was the founder of Arya Samaj?

- Ans
- 1. Rabindranath Tagore
  - 2. Dayanand Saraswati
  - 3. Keshub Chandra Sen
  - 4. Swami Vivekananda

Q.11 Daler Mehndi is primarily a famous singer of pop songs in which Indian language?

- Ans
- 1. English
  - 2. Punjabi
  - 3. Hindi
  - 4. Bengali

Q.12 The five-year plans for India with their duration are given below. Which of the following is correctly matched?

(a)	Second five-year plan	1956-57 to 1960-61
(b)	Third five-year plan	1961-62 to 1965-66
(c)	Fourth five-year plan	1966-67 to 1970-71

- Ans
- 1. Both a and c
  - 2. Both b and c
  - 3. Only a
  - 4. Both a and b

Q.13 Which of the following states/UTs has the first 100% fully digital literate Panchayat in India?

- Ans
- 1. Delhi
  - 2. Puducherry
  - 3. Maharashtra
  - 4. Kerala

Q.14 Former minister of the state and former president of BJP alliance partner IPFT \_\_\_\_\_ received the Padma Shri award (posthumously) in 2023.

- Ans
- 1. Prabhat Choudhury
  - 2. Narendra Chandra Debbarma
  - 3. Rebat Mohan Das
  - 4. Pinaki Das Chowdhury

Q.15 Sakewa is a religious festival celebrated by the Kirat Khambu Rai community of \_\_\_\_\_.

- Ans
- 1. Arunachal Pradesh
  - 2. Sikkim
  - 3. Himachal Pradesh
  - 4. Goa

Q.16 The growth rate of India's population has been declining since \_\_\_\_\_.

- Ans
- 1. 1971
  - 2. 1991
  - 3. 1951
  - 4. 1981

Q.17 As of March 2024, who among the following is the Chairperson of the National Green Tribunal?

- Ans
- 1. Lokeshwar Singh Panta
  - 2. Prakash Shrivastava
  - 3. Ajay Narayan Jha
  - 4. Swatanter Kumar

Q.18 According to the Census of India 2011, most people had out-migrated from \_\_\_\_\_ to other states in India.

- Ans
- 1. Uttar Pradesh and Bihar
  - 2. Rajasthan and Gujarat
  - 3. Uttar Pradesh and Madhya Pradesh
  - 4. Maharashtra and Gujarat

Q.19 National Institute of Mountaineering and Adventure Sports (NIMAS) is located at \_\_\_\_\_.

- Ans
- 1. Mizoram
  - 2. Nagaland
  - 3. Himachal Pradesh
  - 4. Arunachal Pradesh

Q.20 How many squares are there on a chessboard?

- Ans
- 1. 69
  - 2. 67
  - 3. 68
  - 4. 64

Q.21 In which part of the Constitution will you find the six broad categories of Fundamental Rights?

- Ans
- 1. Part II
  - 2. Part III
  - 3. Part IV
  - 4. Part I

Q.22 The financial year in India starts from 1<sup>st</sup> April and ends on \_\_\_\_\_.

- Ans
- 1. 30<sup>th</sup> June
  - 2. 31<sup>st</sup> March
  - 3. 31<sup>st</sup> July
  - 4. 31<sup>st</sup> May

Q.23 What is the balance of trade of a country?

- Ans
- 1. Ratio of international trade
  - 2. Number of exports
  - 3. Difference between imports and exports
  - 4. Number of imports

Q.24 The peninsular plateau of India was a part of which continent earlier?

- Ans
- 1. South America
  - 2. Europe
  - 3. Africa
  - 4. North America

Q.25 In which year did Johannes Nicolaus Bronsted and Thomas Martin Lowry propose the fundamental concept of acids and bases?

- Ans
- 1. 1928
  - 2. 1921
  - 3. 1925
  - 4. 1923

## Combined Higher Secondary Level Examination 2024 Tier I

Exam Date	01/07/2024
Exam Time	11:45 AM - 12:45 PM
Subject	CHSL Exam 2024 Tier I

### Section : English Language

1. The given sentence is divided into four segments. Select the option that has the segment with a grammatical error. She always / likes to / show on / her wealth.

Ans  1. show on  
 2. she always  
 3. likes to  
 4. her wealth.

2. Parts of the following sentence have been underlined and given as options. Select the option that contains an error. If it will rain tomorrow, I will stay at home.

Ans  1. I will  
 2. at home  
 3. will rain  
 4. If it

3. The following sentence has been split into four segments. Identify the segment that contains a grammatical error.  
Hard had she / thrown the basketball / when it fell / on the ground.

Ans  1. when it fell  
 2. on the ground  
 3. thrown the basketball  
 4. Hard had she

- Q.4 Parts of the following sentence have been given as options. Select the option that contains an error. Ramayana is an ancient Sanskrit epic; it is believed to be written around 500 BC to 100 BC.

Ans  1. Ramayana is an ancient  
 2. Sanskrit epic; it is  
 3. believed to be written  
 4. around 500 BC to 100 BC.



**Comprehension:**

In the following passage, some words have been deleted. Read the passage carefully and select the most appropriate option to fill in each blank.

The period from 1858-1905 was the seed time of Indian nationalism; and the early nationalists (1) \_\_\_\_\_ the seeds well and deep. Instead of basing their nationalism or appeals to (2) \_\_\_\_\_ sentiments and passing emotions, or abstract rights of freedom and liberty, or on obscurantist appeals to the past, they \_\_\_\_\_ (3) it in a hard-headed and penetrating analysis of the complex mechanism of modern imperialism and the chief contradiction between the interests of the Indian people and British rule. The result was that they (4) \_\_\_\_\_ a common political and economic programme which (5) \_\_\_\_\_ rather than divided the different sections of the people. Later on, the Indian people could gather around this programme and wage powerful struggles.

**SubQuestion No : 5**

**Q.5** Select the most appropriate option to fill in blank number 1.

- Ans**
- 1. buried
  - 2. scattered
  - 3. threw
  - 4. sowed

**Comprehension:**

In the following passage, some words have been deleted. Read the passage carefully and select the most appropriate option to fill in each blank.

The period from 1858-1905 was the seed time of Indian nationalism; and the early nationalists (1) \_\_\_\_\_ the seeds well and deep. Instead of basing their nationalism or appeals to (2) \_\_\_\_\_ sentiments and passing emotions, or abstract rights of freedom and liberty, or on obscurantist appeals to the past, they \_\_\_\_\_ (3) it in a hard-headed and penetrating analysis of the complex mechanism of modern imperialism and the chief contradiction between the interests of the Indian people and British rule. The result was that they (4) \_\_\_\_\_ a common political and economic programme which (5) \_\_\_\_\_ rather than divided the different sections of the people. Later on, the Indian people could gather around this programme and wage powerful struggles.

**SubQuestion No : 6**

**Q.6** Select the most appropriate option to fill in blank number 2.

- Ans**
- 1. shallow
  - 2. grounded
  - 3. profound
  - 4. deep

**Comprehension:**

In the following passage, some words have been deleted. Read the passage carefully and select the most appropriate option to fill in each blank.

The period from 1858-1905 was the seed time of Indian nationalism; and the early nationalists (1) \_\_\_\_\_ the seeds well and deep. Instead of basing their nationalism or appeals to (2) \_\_\_\_\_ sentiments and passing emotions, or abstract rights of freedom and liberty, or on obscurantist appeals to the past, they \_\_\_\_\_ (3) it in a hard-headed and penetrating analysis of the complex mechanism of modern imperialism and the chief contradiction between the interests of the Indian people and British rule. The result was that they (4) \_\_\_\_\_ a common political and economic programme which (5) \_\_\_\_\_ rather than divided the different sections of the people. Later on, the Indian people could gather around this programme and wage powerful struggles.

**SubQuestion No : 7**

**Q.7** Select the most appropriate option to fill in blank number 3.

- Ans**
- 1. controlled
  - 2. rooted
  - 3. drove
  - 4. minded

**Comprehension:**

In the following passage, some words have been deleted. Read the passage carefully and select the most appropriate option to fill in each blank.

The period from 1858-1905 was the seed time of Indian nationalism; and the early nationalists (1) \_\_\_\_\_ the seeds well and deep. Instead of basing their nationalism or appeals to (2) \_\_\_\_\_ sentiments and passing emotions, or abstract rights of freedom and liberty, or on obscurantist appeals to the past, they \_\_\_\_\_ (3) it in a hard-headed and penetrating analysis of the complex mechanism of modern imperialism and the chief contradiction between the interests of the Indian people and British rule. The result was that they (4) \_\_\_\_\_ a common political and economic programme which (5) \_\_\_\_\_ rather than divided the different sections of the people. Later on, the Indian people could gather around this programme and wage powerful struggles.

**SubQuestion No : 8**

**Q.8** Select the most appropriate option to fill in blank number 4.

- Ans
- 1. evolved
  - 2. banished
  - 3. uprooted
  - 4. collapsed

**Comprehension:**

In the following passage, some words have been deleted. Read the passage carefully and select the most appropriate option to fill in each blank.

The period from 1858-1905 was the seed time of Indian nationalism; and the early nationalists (1) \_\_\_\_\_ the seeds well and deep. Instead of basing their nationalism or appeals to (2) \_\_\_\_\_ sentiments and passing emotions, or abstract rights of freedom and liberty, or on obscurantist appeals to the past, they \_\_\_\_\_ (3) it in a hard-headed and penetrating analysis of the complex mechanism of modern imperialism and the chief contradiction between the interests of the Indian people and British rule. The result was that they (4) \_\_\_\_\_ a common political and economic programme which (5) \_\_\_\_\_ rather than divided the different sections of the people. Later on, the Indian people could gather around this programme and wage powerful struggles.

**SubQuestion No : 9**

**Q.9** Select the most appropriate option to fill in blank number 5.

- Ans
- 1. united
  - 2. dissolved
  - 3. classified
  - 4. complicated

**Q.10** Select the most appropriate option to fill in the blank.

It took 4 hours straight to \_\_\_\_\_ the deal with the regional company.

- Ans
- 1. stop
  - 2. get
  - 3. perform
  - 4. close

**Q.11** Select the most appropriate option that can substitute the underlined segment in the given sentence.

As I have no time to discuss the points, so I wrote a email to her.

- Ans
- 1. so I wrote an e-mail for her
  - 2. so I wrote a e-mail to her
  - 3. I write an email to her
  - 4. I wrote an email to her

**Q.12** Select the most appropriate meaning of the given idiom.

**At one's fingertips**

- Ans
- 1. To be unaware of something
  - 2. To take revenge
  - 3. Out of reach
  - 4. To have complete knowledge

Q.13 Select the most appropriate ANTONYM of the given word.  
Resistance

- Ans
- 1. Awareness
  - 2. Tolerance
  - 3. Tenderness
  - 4. Reliance

Q.14 Select the most appropriate option that can replace the bracketed word segment in the following sentence.  
Children should avoid giving out personal details online (which will) identify them or their location.

- Ans
- 1. what will
  - 2. that could
  - 3. whichever can
  - 4. which might lead

Q.15 Select the most appropriate ANTONYM of the underlined word.  
The rocky terrain made the hike difficult and strenuous.

- Ans
- 1. Demanding
  - 2. Lively
  - 3. Intense
  - 4. Easy

Q.16 Select the most appropriate option that can substitute the underlined segment in the given sentence.

The road which connecting the two states is overcrowded.

- Ans
- 1. connected
  - 2. connects
  - 3. has connecting
  - 4. have connected

Q.17 Select the most appropriate ANTONYM of the underlined word in the given sentence.  
Ria is liked by everyone as she is very amicable.

- Ans
- 1. Hateful
  - 2. Unfriendly
  - 3. Stupid
  - 4. Dangerous

Q.18 Select the option that can be used as a one-word substitute for the given group of words.  
Hospital for people with mental illnesses

- Ans
- 1. Hangar
  - 2. Druggist
  - 3. Asylum
  - 4. Shelter

Q.19 Select the INCORRECTLY spelt word in the given sentence.

A distinguished academecian, Amartya Sen has taught in India, Britain and the United States.

- Ans
- 1. Academecian
  - 2. Taught
  - 3. Britain
  - 4. Distinguished

Q.20 Select the most appropriate meaning of the underlined idiom.

Teja followed his friend's advice so now he is in deep water.

- Ans
- 1. In deep thoughts
  - 2. In dilemma
  - 3. In trouble
  - 4. In good position

Q.21 Select the most appropriate ANTONYM of the underlined word in the given sentence.  
The committee deposed him from his office.

- Ans
- 1. Interacted
  - 2. Demolished
  - 3. Promoted
  - 4. Segregated

Q.22 Select the most appropriate ANTONYM of the underlined word.  
Language interacts with all aspects of human life and society.

- Ans
- 1. co-operates
  - 2. interrelates
  - 3. disconnects
  - 4. intermingles

Q.23 Select the INCORRECTLY spelt word.

- Ans
- 1. Category
  - 2. Hygiene
  - 3. Congratulate
  - 4. Aquire

Q.24 Select the most appropriate ANTONYM of the given word.  
Beautiful

- Ans
- 1. Pungent
  - 2. Stingy
  - 3. Slimy
  - 4. Ugly

Q.25 Select the most appropriate ANTONYM of the word 'Defeat' in the given sentence.

The first battle of Panipat was fought on 21 April 1526, where Babur introduced canon warfare and was able to gain victory on Delhi and subjugated sultanate ruler Ibrahim Lodi.

- Ans
- 1. gain
  - 2. subjugated
  - 3. warfare
  - 4. victory

Section : General Intelligence

1. Select the combination of letters that when sequentially placed in the blanks of the given series will complete the series.

KJ\_HIJKI\_JM\_EJ\_K

- Ans
- 1. GIJO
  - 2. IGJO
  - 3. IMKR
  - 4. KJOM

2. 'Q + R' means 'Q is the father of R'  
 'Q - R' means 'Q is the wife of R'  
 'Q × R' means 'Q is the brother of R'  
 'Q ÷ R' means 'Q is the daughter of R'.  
 What does 'M - N + O' mean?

- Ans
- 1. M is the brother of O
  - 2. M is the daughter of O
  - 3. M is the mother of O
  - 4. M is the father of O

- Q.3 What would be the word on the opposite side of 'Blue' if the given sheet is folded to form a cube?

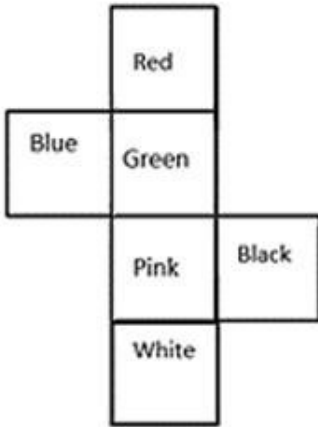

- Ans
- 1. Black
  - 2. Red
  - 3. Pink
  - 4. White

- Q.4 Select the correct mirror image of the given combination when the mirror is placed at MN as shown below.



- Ans
- 1. Rēb∟7ΛH
  - 2. Rēp∟7ΛH
  - 3. deR∟7ΛH
  - 4. Rēb∟7ΛH

**Q.5** In this question, three statements are given, followed by three conclusions numbered I, II and III. Assuming the statements to be true, even if they seem to be at variance with commonly known facts, decide which of the conclusion(s) logically follows/follow from the statements.

Statements:

All rings are earrings.

Some rings are chains.

All chains are bangles.

Conclusions:

I. Some rings are bangles.

II. Some earrings are bangles.

III. Some chains are earrings.

- Ans**
- 1. Both conclusions II and III follow.
  - 2. All conclusions I, II and III follow.
  - 3. Both conclusions I and III follow.
  - 4. Both conclusions I and II follow.

**Q.6** Select the word-pair that best represents a similar relationship to the one expressed in the pair of words given below.

(The words must be considered as meaningful English words and must not be related to each other based on the number of letters/number of consonants/vowels in the word)

Hand : Wrist

- Ans**
- 1. Skull : Stomach
  - 2. Muscle : Bone
  - 3. Ear : Hair
  - 4. Foot : Ankle

**Q.7** Based on the alphabetical order, three of the following four letter-clusters are alike in a certain way and thus form a group. Which letter-cluster does not belong to that group?

(Note: The odd one out is not based on the number of consonants/vowels or their position in the letter cluster.)

- Ans**
- 1. QNL
  - 2. ROL
  - 3. WTQ
  - 4. LIF

**Q.8** Select the set in which the numbers are related in the same way as are the numbers of the following sets.  
(NOTE : Operations should be performed on the whole numbers, without breaking down the numbers into its constituent digits. E.g. 13 – Operations on 13 such as adding /subtracting /multiplying etc. to 13 can be performed. Breaking down 13 into 1 and 3 and then performing mathematical operations on 1 and 3 is not allowed)

(21, 34, 76)

(39, 26, 104)

- Ans**
- 1. (34, 25, 102)
  - 2. (37, 43, 127)
  - 3. (25, 31, 108)
  - 4. (28, 23, 79)

Q.9 Which figure should replace the question mark (?) if the following figure series were to be continued?

△	♡	♡	C	C	S	S	A									
S	A	R	C	9	R	A	△	△	9	R	A	♡	R	9	C	?
O	9	S		O	O		♡	△								

Ans

✗ 1.

△	O
S	9 R A
♡	C

✓ 2.

A	△
C	♡ R 9
O	S

✗ 3.

O	S
R	9 C ♡
A	△

✗ 4.

O	S
C	♡ R 9
A	△

Q.10 How many squares are there in the given figure?

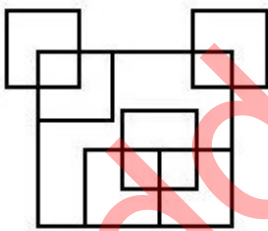

- Ans
- ✗ 1. 9
  - ✓ 2. 11
  - ✗ 3. 12
  - ✗ 4. 10

Q.11 If 'T' stands for '×', 'M' stands for '+', 'K' stands for '÷' and 'G' stands for '-', what will come in place of the question mark (?) in the following equation?

$$100 K 5 M 73 T 48 M 56 G 23 = ?$$

- Ans
- ✗ 1. 3500
  - ✗ 2. 3560
  - ✓ 3. 3557
  - ✗ 4. 3575

Q.12 In a certain code language, 'KIOSK' is coded as 'LJRTL' and 'FLAME' is coded as 'GMDNF'. What is the code for 'ENJOY' in the given code language?

- Ans
- 1. EMOQY
  - 2. FOMPZ
  - 3. ENOQZ
  - 4. GNMRY

Q.13 11 is related to 55 following a certain logic. Following the same logic, 22 is related to 110. To which of the following is related 44 following the same logic?  
(NOTE : Operations should be performed on the whole numbers, without breaking down the numbers into its constituent digits. E.g. 13 – Operations on 13 such as adding /deleting /multiplying etc., to 13 can be performed. Breaking down 13 into 1 and 3 and then performing mathematical operations on 1 and 3 is not allowed.)

- Ans
- 1. 230
  - 2. 200
  - 3. 220
  - 4. 210

Q.14 What would be the letter on the opposite side of 'K' if the given sheet is folded to form a cube?

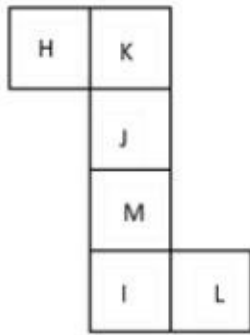

- Ans
- 1. L
  - 2. M
  - 3. H
  - 4. I

Q.15 What will come in the place of '?' in the following equation, if '+' and '÷' are interchanged and '×' and '-' are interchanged?

$$21 + 3 - 7 \div 11 \times 4 = ?$$

- Ans
- 1. 63
  - 2. 48
  - 3. 51
  - 4. 56



Q.16 Select the option figure in which the given figure (X) is embedded as its part (rotation is NOT allowed).



(X)

Ans

✗ 1.

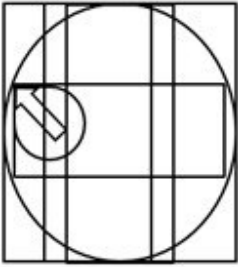

✗ 2.

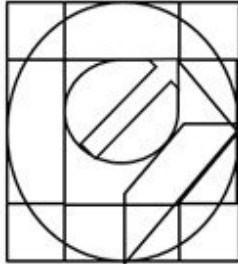

✗ 3.

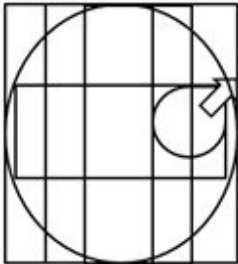

✓ 4.

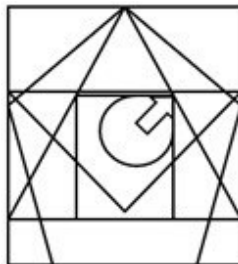

Q.17 What should come in place of ? in the given series based on the English alphabetical order?

ZRJ EUK JXL ? TDN

Ans

✓ 1. OAM

✗ 2. HST

✗ 3. WNE

✗ 4. QHR

Q.18 What should come in place of the question mark (?) in the given series?

162, 167, 172, 177, 182, ?

Ans

✓ 1. 187

✗ 2. 186

✗ 3. 188

✗ 4. 185

Q.19 In a certain code language, 'messages are encrypted' is written as 'tg gc mz' and 'are you coming' is written as 'ze fp mz'. How is 'are' written in the given language?

- Ans
- 1. mz
  - 2. fp
  - 3. ze
  - 4. gc

Q.20 Select the correct mirror image of the given figure when the mirror is placed at MN as shown below.

**D U P E 5 2 S H**  
M ————— N

- Ans
- 1. **D U P E 2 5 2 H**
  - 2. **H 2 5 2 3 9 U D**
  - 3. **D P U E 2 5 2 H**
  - 4. **H 2 2 3 9 U D**

Q.21 If 15 December 2006 is a Friday, then what will the day of the week on 13 October 2009?

- Ans
- 1. Monday
  - 2. Friday
  - 3. Saturday
  - 4. Tuesday

Q.22 Which of the following numbers will replace the question mark (?) in the given series?

54 58.7 64.4 71.1 78.8 ?

- Ans
- 1. 86.8
  - 2. 87.5
  - 3. 84.4
  - 4. 85.1

Q.23 If 'Z' stands for '+', 'Q' stands for '×', 'H' stands for '+' and 'E' stands for '−', what will come in place of the question mark (?) in the following equation?

17 H 23 Q 42 Z 7 E 13 = ?

- Ans
- 1. 975
  - 2. 785
  - 3. 142
  - 4. 688

Q.24 Select the word-pair that best represents a similar relationship to the one expressed in the pair of words given below. (The words must be considered as meaningful English words and must not be related to each other based on the number of letters/number of consonants/vowels in the word.)

Continue – Interrupt

- Ans
- 1. Connect – Join
  - 2. Safe – Secure
  - 3. Cow – Buffalo
  - 4. Attic – Common

Q.25 If 6 May 2005 is a Friday, then what will the day of the week on 25 September 2018?

- Ans
- 1. Tuesday
  - 2. Thursday
  - 3. Sunday
  - 4. Friday

Section : Quantitative Aptitude

1. The age of the older of two boys is thrice that of the younger. 9 years ago it was five times that of the younger. Find the present age of each.

- Ans
- 1. 15 years, 45 years
  - 2. 12 years, 36 years
  - 3. 17 years, 51 years
  - 4. 18 years, 54 years

Q.2 The price of an electric bike was ₹1,25,000 last year. This year, its price got decreased by 30%. What is the price (in ₹) of the electric bike this year?

- Ans
- 1. 86,000
  - 2. 87,500
  - 3. 86,500
  - 4. 87,000

Q.3 The respective ratio between numerical values of the curved surface area and the volume of a right circular cylinder is 2 : 3. If the respective ratio between the radius and the height of the cylinder is 3 : 7, what is the total surface area of the cylinder?

- Ans
- 1.  $62\pi \text{ cm}^2$
  - 2.  $60\pi \text{ cm}^2$
  - 3.  $45\pi \text{ cm}^2$
  - 4.  $65\pi \text{ cm}^2$

Q.4 Find the number when successively divided by 3, 5 and 7 leaves remainder 2, 1 and 3, respectively, and the last quotient is 3.

- Ans
- 1. 360
  - 2. 362
  - 3. 365
  - 4. 367

Q.5 In a circle, ABCD is a cyclic quadrilateral in which AE is drawn parallel to CD, and BA is produced to F. If  $\angle ABC = 85^\circ$  and  $\angle FAE = 24^\circ$ , find the value of  $\angle BCD$ .

- Ans
- 1.  $125^\circ$
  - 2.  $115^\circ$
  - 3.  $124^\circ$
  - 4.  $119^\circ$

Q.6 If 18 toys out of 75 toys are for boys and the rest are for girls, what is the percentage of girls toys?

- Ans
- 1. 18%
  - 2. 57%
  - 3. 67%
  - 4. 76%

Q.7 A person drives 110 miles at 55 miles per hour, he drives the next 120 miles at 60 miles per hour, and then he drives the next 60 miles in an hour. What is his average speed for the entire journey in miles per hour ?

- Ans
- 1. 58
  - 2. 55
  - 3. 63
  - 4. 60

Q.8 In a  $\triangle ABC$ , two medians AD and BE intersect at G at right angles. If AD = 18 cm and BE = 12 cm, then the length of BD is equal to:

- Ans
- 1. 10 cm
  - 2. 15 cm
  - 3. 8 cm
  - 4. 20 cm

Q.9 What is the value of the following expression?

$$\frac{4}{7} \times 4\frac{1}{2} \div 5\frac{1}{3} \text{ of } 2\frac{1}{2} - \left( 7\frac{7}{8} \div 5\frac{1}{9} \text{ of } 9\frac{9}{20} \right) + \frac{1}{2}$$

- Ans
- 1.  $\frac{853}{1610}$
  - 2.  $\frac{1093}{111}$
  - 3.  $\frac{1113}{856}$
  - 4.  $\frac{1759}{3250}$

Q.10 The surface areas of two spheres are in the ratio 25 : 36. What is the ratio of their volumes?

- Ans
- 1.  $\frac{25}{36}$
  - 2.  $\frac{36}{115}$
  - 3.  $\frac{125}{216}$
  - 4.  $\frac{36}{125}$

Q.11 The following bar graph shows the sales (in thousands) of magazines from six branches (A, B, C, D, E and F) of a publishing company during two consecutive years 2021 and 2022.

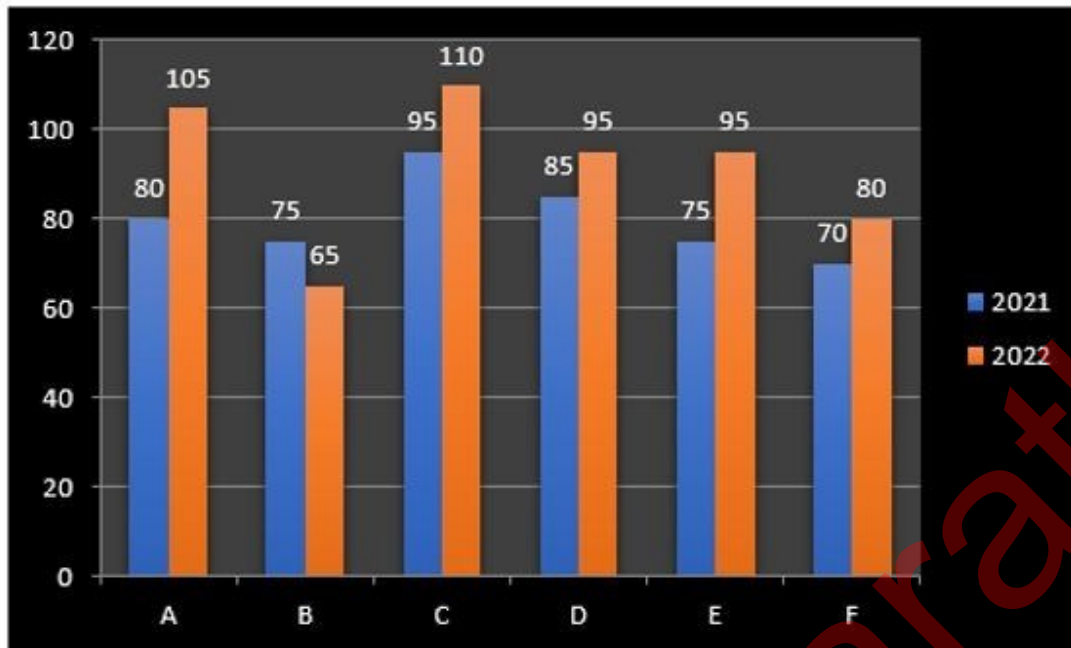

What percent of the average sales of branches A, B and C in 2022 is the average sales of branches A, C and F in 2021?

- Ans
- 1. 86.2%
  - 2. 88.4%
  - 3. 87.5%
  - 4. 82.3%

Q.12 A and B can do a piece of work in eight days and B alone can do it in 16 days. In how many days, can A do it alone?

- Ans
- 1. 24 days
  - 2. 10 days
  - 3. 18 days
  - 4. 16 days

Q.13 If  $\sin\theta = \frac{2xy}{x^2+y^2}$ , then the value of  $\tan\theta$  is:

- Ans
- 1.  $\frac{x^2 + y^2}{x^2 - y^2}$
  - 2.  $\frac{2xy}{x^2 - y^2}$
  - 3.  $\frac{x^2 - y^2}{2xy}$
  - 4.  $\frac{x^2 - y^2}{x^2 + y^2}$

Q.14 PQ is a diameter of a circle with centre O. The tangents at R meets PQ produced at A. If  $\angle RPQ = 27^\circ$ , then measure of  $\angle RQP$  is:

- Ans
- 1.  $63^\circ$
  - 2.  $54^\circ$
  - 3.  $153^\circ$
  - 4.  $27^\circ$

Q.15 Ram travelled an equal distance with the speed of 40 km/hr, 45 km/hr and 60 km/hr. What is the average speed of Ram during the whole journey? Correct to two decimal places.

- Ans
- 1. 66.94 km/hr
  - 2. 94.66 km/hr
  - 3. 64.96 km/hr
  - 4. 46.96 km/hr

Q.16 Three persons ran for office and got, 1136, 7636 and 11628 votes, respectively. What was the winning candidate's percentage of the total votes?

- Ans
- 1. 52%
  - 2. 61%
  - 3. 59%
  - 4. 57%

Q.17 Ravi sells his goods at a 25% loss on cost price but uses 45% less weight. What is his percentage profit or loss?

- Ans
- 1. Profit,  $47\frac{9}{10}\%$
  - 2. Loss,  $36\frac{4}{11}\%$
  - 3. Loss,  $47\frac{9}{10}\%$
  - 4. Profit,  $36\frac{4}{11}\%$

Q.18 Two circles touch each other at a point O. AB is a simple common tangent to both the circles touching at point A and point B. If radii of the circles are 9 cm and 4 cm, then find AB.

- Ans
- 1. 72 cm
  - 2. 144 cm
  - 3. 12 cm
  - 4. 24 cm

Q.19 If  $2^3 : 8^{5.06} :: 8^{-4.06} : x$ , find the value of x.

- Ans
- 1.  $\frac{1}{2^3}$
  - 2. 1
  - 3.  $2^3$
  - 4. 0

**Q.20** The following graph shows the production (in thousands) of two types (A and B) of cars by a company over the years 2016 to 2021.

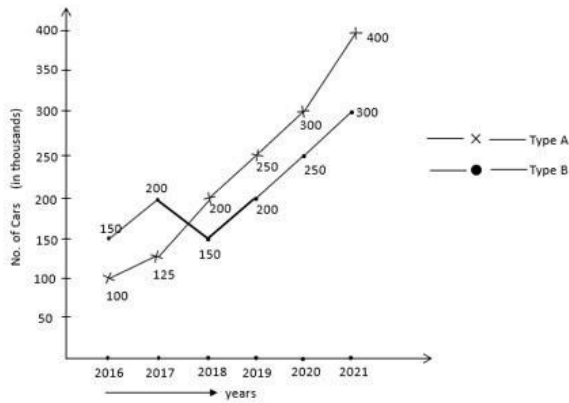

In how many of the given years was the production of type A cars more than the average production of this type car in the given years?

- Ans**
- 1. 2
  - 2. 3
  - 3. 1
  - 4. 4

**Q.21** The given table shows the marks obtained by 100 students out of 50 marks in Mathematics and Physics in an examination.

Marks / Subjects	40 or above	30 or above	20 or above	10 or above	0 or above
Mathematics	9	32	80	92	100
Physics	4	21	66	81	100
Average	7	27	73	87	100

If at least 60% marks in Physics are required for pursuing higher studies in Physics, how many students will be eligible to pursue higher studies in Physics?

- Ans**
- 1. 27
  - 2. 81
  - 3. 66
  - 4. 21

**Q.22** Reshma took a loan of ₹12,00,000 with simple interest for as many years as the rate of interest. If she paid ₹9,72,000 as interest at the end of the loan period, what was the rate of interest per annum ?

- Ans**
- 1. 7.5%
  - 2. 8%
  - 3. 8.7%
  - 4. 9%

Q.23 The value of  $\left(\frac{7+8 \times 7 \div 8+7 \div 7 \div 7}{3+3 \times 3 \div 3+5 \div 5 \div 5}\right)$  is :

- Ans
- 1.  $3 \frac{27}{217}$
  - 2.  $1 \frac{81}{217}$
  - 3.  $2 \frac{61}{217}$
  - 4.  $1 \frac{31}{217}$

Q.24 The sides of a cuboid are in the ratio 3 : 4 : 5 and its surface area is equal to the surface area of the cube with side 6 units. What is the approximate volume of the cuboid?

- Ans
- 1. 210
  - 2. 150
  - 3. 240
  - 4. 180

Q.25 Study the given three-dimensional chart and answer the question that follows. The chart details the sale of fruits in different months.

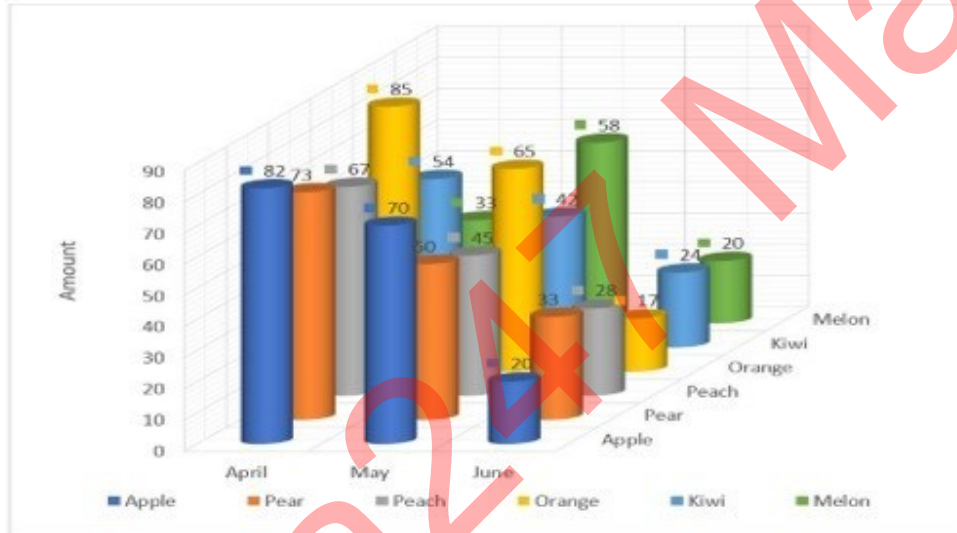

In which month was the sale of Melons the lowest and by how much was it more than the sale of Oranges in that month?

- Ans
- 1. June, 4
  - 2. June, 3
  - 3. April, 3
  - 4. May, 3

Section : General Awareness

1. Which of the following is NOT a stringed instrument?

- Ans
- 1. Flute
  - 2. Violin
  - 3. Mandolin
  - 4. Guitar



2. Which power were the Badami (or Vatapi) Chalukyas originally subjects of?

- Ans
- 1. Hoysalas
  - 2. Pallavas
  - 3. Pandyas
  - 4. Kadambas

Q.3 According to the National Crime Records Bureau data, from 2016 to 2019, suicide cases due to unemployment have increased by \_\_\_\_\_.

- Ans
- 1. 21%
  - 2. 24%
  - 3. 18%
  - 4. 20%

Q.4 When was the Swarnajayanti Gram Swarozgar Yojana (SGSY) launched by the Government of India?

- Ans
- 1. 1995
  - 2. 1999
  - 3. 2000
  - 4. 1991

Q.5 In the given main characteristics of farming which is NOT a characteristic of the Indian commercial farming?

- Ans
- 1. Slash and burn
  - 2. Chemical fertilisers
  - 3. Insecticides and pesticides
  - 4. High yielding variety seeds

Q.6 ICC World Cup (cricket) 2023 was hosted by \_\_\_\_\_.

- Ans
- 1. India
  - 2. India and Bangladesh
  - 3. India, Sri Lanka and Bangladesh
  - 4. India and Sri Lanka

Q.7 Who was the chief coordinator for the G20 summit which held in India in 2023?

- Ans
- 1. S Jaishankar
  - 2. Vinay Kwatra
  - 3. Harsh Vardhan Shringla
  - 4. Vijay Gokhale

Q.8 On 26 January 1950 India became:

- Ans
- 1. a sovereign, democratic, republic state
  - 2. a socialist and secular state
  - 3. an independent state
  - 4. a unitary state

Q.9 Which of the following is NOT one of the main pillars of the 'Namami Gange Programme', launched by the Government of India in 2014?

- Ans
- 1. Sewerage Treatment Infrastructure
  - 2. River-Front Development
  - 3. Industrial Effluent Monitoring
  - 4. River Linkage Development

Q.10 The song 'Teri mitti' is from which of the following movies?

- Ans
- 1. Kesari
  - 2. Rajniti
  - 3. Satya Mev Jayte
  - 4. Jai Ho

Q.11 Which of the following statements about eutrophication is correct?

- Ans
- 1. It happens when too much carbon enriches the water, causing excessive growth of bacteria and reduced growth of plants.
  - 2. It happens when too less nitrogen is present in the water, causing reduced growth of plants and algae.
  - 3. It is a beneficial process for environment restoration.
  - 4. It happens when too much nitrogen enriches the water, causing excessive growth of plants and algae.

Q.12 Mohammad Yunus established which of the following banks in 1983?

- Ans
- 1. Indian Bank
  - 2. Union Bank
  - 3. State Bank
  - 4. Grameen Bank

Q.13 In which year did Robert Brown observe the zigzag movement of colloidal particles in solution?

- Ans
- 1. 1829
  - 2. 1826
  - 3. 1828
  - 4. 1827

Q.14 Which of the following are needed for Skype to function on a computer?

- 1) A web cam
- 2) A microphone
- 3) A speaker

- Ans
- 1. Only 1 and 3
  - 2. 1, 2 and 3
  - 3. Only 2 and 3
  - 4. Only 1 and 2

Q.15 In year 2023, the Government of India launched which of the following schemes to bring Indian-origin researchers to higher educational institutions in the country?

- Ans
- 1. VAIBHAV
  - 2. AMANTRAN
  - 3. VAPSI
  - 4. SEEKHO

Q.16 Which is, by far, the closest dwarf planet orbiting at only 2.8 times Earth's distance from the sun?

- Ans
- 1. Makemake
  - 2. Pluto
  - 3. Eris
  - 4. Ceres

Q.17 According to Global Multidimensional poverty index (2022), which of the following groups of states is included in top 10 poorest states of India?

- Ans
- 1. Punjab and Gujarat
  - 2. Manipur and Nagaland
  - 3. Karnataka and Tamil Nadu
  - 4. Meghalaya and Madhya Pradesh

Q.18 The default width of a column in MS-Excel is:

- Ans
- 1. 7 characters
  - 2. 9 characters
  - 3. 8 characters
  - 4. 6 characters

Q.19 Which of the following statements is correct about the Five-Year Plan?

- Ans
- 1. All Five-Year Plans have equal rates of growth.
  - 2. The Planning Commission was constituted in 1951.
  - 3. The first Five-Year Plan was started in 1951.
  - 4. The President was the ex-officio chairperson of the Planning Commission.

Q.20 Who among the followings won gold at the International Shooting Sport Federation (ISSF) junior world cup 2023? Ans

- 1. Mahesh Pasupathy Anandakumar
- 2. Rajkanwar Singh Sandhu
- 3. Umamahesh Maddineni
- 4. Dhanush Srikanth

Q.21 \_\_\_\_\_ is one of the first criticism of the caste system written by Mahatma Phule and published in the year 1873.

- Ans
- 1. Gulami Ki Kahani
  - 2. Gulamgiri
  - 3. Bharat Mein Jaati Evam Prajaati
  - 4. Jati ka Unmoolan

Q.22 Which of the following parts of the Indian Constitution is described as the 'Magna Carta of India'?

- Ans
- 1. Part IV
  - 2. Part II
  - 3. Part III
  - 4. Part I

Q.23 'Hampi Utsava,' which is celebrated in Karnataka, is also called \_\_\_\_\_. The festival that captures the pomp, splendour and glory of the historical period of Karnataka is celebrated over a week.

- Ans
- 1. Sarhul Mahotsava
  - 2. Rajasi Utsava
  - 3. Vijaya Utsava
  - 4. Nritya Mahotsav

Q.24 Nehru Institute of Mountaineering is located at \_\_\_\_\_.

- Ans
- 1. Leh
  - 2. Jammuand Kashmir
  - 3. Himachal Pradesh
  - 4. Uttarakhand

Q.25 Which of the following dances developed in the monasteries of Assam?

- Ans
- 1. Kuchipudi
  - 2. Kathak
  - 3. Bharatanatyam
  - 4. Sattriya

Adda247 Marathi

## Combined Higher Secondary Level Examination 2024 Tier I

Exam Date	01/07/2024
Exam Time	2:30 PM - 3:30 PM
Subject	CHSL Exam 2024 Tier I

### Section : English Language

1. The following sentence has an error in its tense. Identify the error and select the correct sentence from the options.

If you had apprised me about your problem earlier, I would have allow you to go.

- Ans
- 1. If you had apprised me about your problem earlier, I would have allowed you to go.
  - 2. If you apprised me about your problem earlier, I would have allowed you to go.
  - 3. If you had apprised me about your problem earlier, I would allow you to go.
  - 4. If you can apprise me about your problem earlier, I would have allowed you to go.

2. Select the option with the correct use of article(s).

- Ans
- 1. She kept lot of rules in her life, due to which she is flourishing today.
  - 2. She kept an lot of rules in her life, due to which she is flourishing today.
  - 3. She kept a lot of rules in her life, due to which she is flourishing today.
  - 4. She kept the lot of rules in her life, due to which she is flourishing today.

3. The following sentence has been divided into parts. One of them may contain an error. Select the part that contains the error from the given options. If you don't find any error, mark 'No error' as your answer.

The project was completed / more quicker / than expected.

- Ans
- 1. No error
  - 2. more quicker
  - 3. The project was completed
  - 4. than expected

Q.4 There is an error in the given sentence. From the options given, identify the sentence that corrects the error to make it a grammatically accurate sentence.

Harmit is not innocent such as Uday.

- Ans
- 1. Harmit is not as innocent more than Uday.
  - 2. Harmit is not as much as innocent as Uday.
  - 3. Harmit is not as innocent as Uday.
  - 4. Harmit is not innocent than Uday.

**Comprehension:**

In the following passage, some words have been deleted. Read the passage carefully and select the most appropriate option to fill in each blank.

Many parents think of overweight children as 'cute' and cuddly. However, obesity must not be (1) \_\_\_\_\_ as a healthy sign. (2) \_\_\_\_\_ obese children grow up, they will be more prone (3) \_\_\_\_\_ health problems like high blood pressure (4) \_\_\_\_\_ diabetes. Today, overweight children are becoming a common (5) \_\_\_\_\_ in many countries.

**SubQuestion No : 5**

**Q.5** Select the most appropriate option to fill in blank no. 1.

- Ans**
- 1. saw
  - 2. seen
  - 3. see
  - 4. seeing

**Comprehension:**

In the following passage, some words have been deleted. Read the passage carefully and select the most appropriate option to fill in each blank.

Many parents think of overweight children as 'cute' and cuddly. However, obesity must not be (1) \_\_\_\_\_ as a healthy sign. (2) \_\_\_\_\_ obese children grow up, they will be more prone (3) \_\_\_\_\_ health problems like high blood pressure (4) \_\_\_\_\_ diabetes. Today, overweight children are becoming a common (5) \_\_\_\_\_ in many countries.

**SubQuestion No : 6**

**Q.6** Select the most appropriate option to fill in blank no. 2.

- Ans**
- 1. When
  - 2. Who
  - 3. What
  - 4. Where

**Comprehension:**

In the following passage, some words have been deleted. Read the passage carefully and select the most appropriate option to fill in each blank.

Many parents think of overweight children as 'cute' and cuddly. However, obesity must not be (1) \_\_\_\_\_ as a healthy sign. (2) \_\_\_\_\_ obese children grow up, they will be more prone (3) \_\_\_\_\_ health problems like high blood pressure (4) \_\_\_\_\_ diabetes. Today, overweight children are becoming a common (5) \_\_\_\_\_ in many countries.

**SubQuestion No : 7**

**Q.7** Select the most appropriate option to fill in blank no. 3.

- Ans**
- 1. to
  - 2. in
  - 3. at
  - 4. on

**Comprehension:**

In the following passage, some words have been deleted. Read the passage carefully and select the most appropriate option to fill in each blank.

Many parents think of overweight children as 'cute' and cuddly. However, obesity must not be (1) \_\_\_\_\_ as a healthy sign. (2) \_\_\_\_\_ obese children grow up, they will be more prone (3) \_\_\_\_\_ health problems like high blood pressure (4) \_\_\_\_\_ diabetes. Today, overweight children are becoming a common (5) \_\_\_\_\_ in many countries.

**SubQuestion No : 8**

**Q.8** Select the most appropriate option to fill in blank no. 4.

- Ans**
- 1. neither
  - 2. or
  - 3. nor
  - 4. never

**Comprehension:**

In the following passage, some words have been deleted. Read the passage carefully and select the most appropriate option to fill in each blank.

Many parents think of overweight children as 'cute' and cuddly. However, obesity must not be (1) \_\_\_\_\_ as a healthy sign. (2) \_\_\_\_\_ obese children grow up, they will be more prone (3) \_\_\_\_\_ health problems like high blood pressure (4) \_\_\_\_\_ diabetes. Today, overweight children are becoming a common (5) \_\_\_\_\_ in many countries.

**SubQuestion No : 9**

**Q.9** Select the most appropriate option to fill in blank no. 5.

- Ans
- 1. sight
  - 2. might
  - 3. light
  - 4. tight

**Q.10** Select the most appropriate option that can substitute the underlined segment in the given sentence.

Riding a horse was a piece of cake for him.

- Ans
- 1. an everyday affair
  - 2. a very easy task
  - 3. confusing work
  - 4. a very difficult task

**Q.11** Select the most appropriate meaning of the given idiom.  
Blowing smoke

- Ans
- 1. To tease someone relentlessly
  - 2. To hide something
  - 3. To burn something important
  - 4. To lie to perplex others

**Q.12** Select the most appropriate ANTONYM of the underlined word in the given sentence.  
It is no exaggeration to say the Hussain Sagar Lake is an integral element of Hyderabad and Hyderabad's history.

- Ans
- 1. essential
  - 2. total
  - 3. extra
  - 4. inherent

**Q.13** Select the most appropriate ANTONYM of the underlined word in the given sentence.  
His opponents viewed him as stubborn, dogmatic, and inflexible.

- Ans
- 1. Dishonest
  - 2. Biased
  - 3. Careless
  - 4. Amenable

**Q.14** Select the INCORRECTLY spelt word.

- Ans
- 1. Foresee
  - 2. Rebuke
  - 3. Seize
  - 4. Dissappoint

**Q.15** Select the option that will most suitably substitute the underlined part of the given sentence.  
He was not happy until he gave up his job and live as a fakir in the forests.

- Ans
- 1. unless he gave up his job and lives
  - 2. until he gave up his job and lived
  - 3. until he gave up his job and lives
  - 4. until he gives up his job and lived

Q.16 Select the most appropriate ANTONYM of the word 'bold' in the given sentence.  
A person can be friendly, timid, clever, or fearless based on the context of the situation.

- Ans
- 1. friendly
  - 2. clever
  - 3. timid
  - 4. fearless

Q.17 Select the INCORRECTLY spelt word in the given sentence.

'Vande Mataram', a poignant poem, is obviously and indisputably the premier national song of India.

- Ans
- 1. Obviously
  - 2. Premier
  - 3. Indisputably
  - 4. Poignant

Q.18 Select the most appropriate homonyms from the given alternatives to fill in the blanks.

He \_\_\_\_\_ imitate the playful movement of the \_\_\_\_\_.

Alternatives:

A.does (female deer)

B.does

C.dose

- Ans
- 1. C, B
  - 2. B, A
  - 3. A, B
  - 4. A, C

Q.19 Select the most appropriate option that can substitute the underlined segment in the given sentence.  
Dhruv's anger blazed of uncontrollably.

- Ans
- 1. anger blazed onwards
  - 2. anger blazed after
  - 3. anger blazed up
  - 4. anger blazed into

Q.20 Select the most appropriate option to substitute the underlined segment in the following sentence.  
The company do not broke the law at any time.

- Ans
- 1. do not brakes
  - 2. did not breaking
  - 3. did not broken
  - 4. does not break

Q.21 Select the most appropriate homonym to fill in the blank.

Sonu eats \_\_\_\_\_ like a rabbit.

- Ans
- 1. karat
  - 2. carrot
  - 3. carat
  - 4. caret

Q.22 Select the most appropriate option that can best replace the bracketed word to fill in the blank  
His \_\_\_\_\_ stature was not a measure of his overall personality. (scrawny)

- Ans
- 1. muscular
  - 2. thin
  - 3. keen
  - 4. sickly



Q.23 Select the most appropriate option that can substitute the underlined word in the given sentence.  
The family was saved from the burning building by the brave firefighter.

- Ans
- 1. fearless
  - 2. unafraid
  - 3. timid
  - 4. cowardly

Q.24 Select the most appropriate synonym of the given word.  
Respect

- Ans
- 1. Honour
  - 2. Disrespect
  - 3. Attend
  - 4. Invalidate

Q.25 Select the most appropriate ANTONYM of the given word.  
Shame

- Ans
- 1. Disgrace
  - 2. Defamation
  - 3. Pride
  - 4. Fear

Section : General Intelligence

Q.1 Select the word-pair that best represents a similar relationship to the one expressed in the pair of words given below.

(The words must be considered as meaningful English words and must not be related to each other based on the number of letters/number of consonants/vowels in the word)

Modest : Humble

- Ans
- 1. Obvious : Evident
  - 2. Knowledge : Ignorance
  - 3. Brave : Fearful
  - 4. Success : Failure

Q.2 What will come in the place of the question mark (?) in the following equation, if '+' and '×' are interchanged and '-' and '÷' are interchanged?

$$46 \times 17 + 4 \div 98 - 7 = ?$$

- Ans
- 1. 80
  - 2. 90
  - 3. 85
  - 4. 100

Q.3 Select the correct mirror image of the given figure when the mirror is placed at MN as shown below.

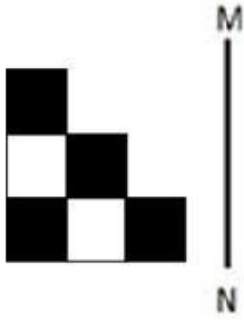

Ans

✗ 1.

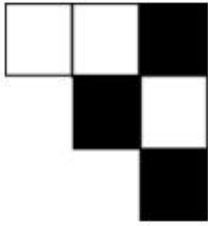

✓ 2.

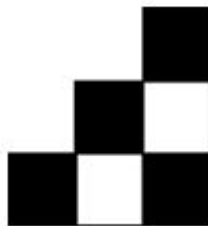

✗ 3.

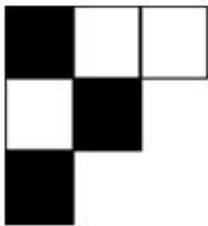

✗ 4.

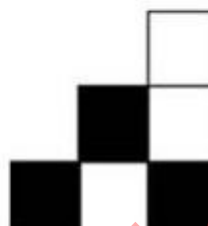

Q.4 Which of the following numbers will replace the question mark (?) in the given series?  
119 171 223 275 327 ?

Ans ✗ 1. 386

✓ 2. 379

✗ 3. 357

✗ 4. 369

Q.5 What should come in place of ? in the given series?

4 13 ? 58 94 139 193

Ans ✗ 1. 36

✗ 2. 27

✗ 3. 26

✓ 4. 31

Q.6 How many triangles are there in the given figure?

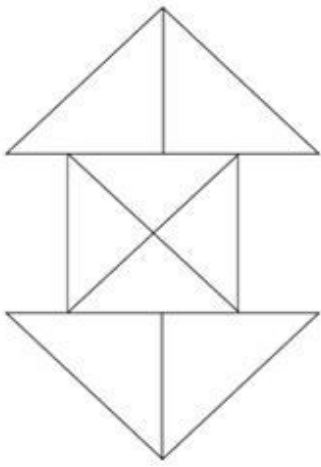

- Ans
- 1. 14
  - 2. 16
  - 3. 15
  - 4. 12

Q.7 What will come in the place of '?' in the following equation, if '+' and '-' are interchanged and '×' and '÷' are interchanged?

$$14 + 6 \times 3 \div 7 - 2 = ?$$

- Ans
- 1. 8
  - 2. 3
  - 3. 10
  - 4. 2

Q.8 Read the given statements and conclusions carefully. Assuming that the information given in the statements is true, even if it appears to be at variance with commonly known facts, decide which of the given conclusions logically follow(s) from the statements.

Statements:

Some handles are bars.

All bars are rods.

No rod is a stick.

Conclusions:

(I) Some handles are rods.

(II) No bar is a stick.

- Ans
- 1. None of the conclusions follow
  - 2. Only conclusion II follows
  - 3. Both conclusions I and II follow
  - 4. Only conclusion I follows

Q.9 Identify the figure given in the options that when put in place of the question mark (?) will logically complete the series.

4	S	☆	A	
8	☆	S	8	?
☆ S A A 4 8 8 A 4 4 ☆ S				

Ans

✗ 1.

8		
A		
☆ S 4		

✓ 2.

8		
A		
S 4 ☆		

✗ 3.

☆		
A		
S 8 4		

✗ 4.

4		
☆		
S 8 A		

Q.10 Select the pair which follows the same pattern as that followed by the two set of pairs given below. Both pairs follow the same pattern.

CJM : FMP

AHL : DKO

- Ans
- ✗ 1. LTV : TVL
  - ✗ 2. KOQ : PLJ
  - ✓ 3. NRS : QUV
  - ✗ 4. GHA : AHG

Q.11 If 15 August 2006 is a Tuesday, then what will the day of the week on 19 February 2012?

- Ans
- ✗ 1. Friday
  - ✓ 2. Sunday
  - ✗ 3. Saturday
  - ✗ 4. Tuesday

Q.12 In a certain code language, 'CERTAIN' is coded as '9643821' and 'UNCERTAIN' is coded as '964382117'. What is the code for 'U' in that language?

- Ans
- 1. 7
  - 2. 1
  - 3. 6
  - 4. 4

Q.13 What would be the number on the opposite side of '20' if the given sheet is folded to form a cube?

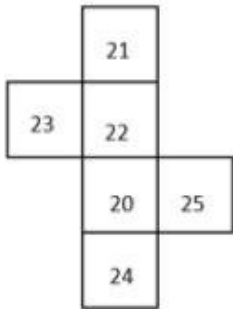

- Ans
- 1. 21
  - 2. 22
  - 3. 23
  - 4. 25

Q.14 Select the set in which the numbers are related in the same way as are the numbers of the given sets.  
(NOTE: Operations should be performed on the whole numbers, without breaking down the numbers into its constituent digits. E.g., 13 – Operations on 13 such as adding/subtracting/multiplying etc. to 13 can be performed. Breaking down 13 into 1 and 3 and then performing mathematical operations on 1 and 3 is not allowed.)  
(111, 16, 7)  
(167, 14, 12)

- Ans
- 1. (190, 21, 9)
  - 2. (140, 8, 17)
  - 3. (131, 12, 11)
  - 4. (108, 9, 12)

Q.15 Three of the following four letter-clusters are alike in a certain way and thus form a group. Which letter-cluster does NOT belong to that group?  
(Note: The odd one out is not based on the number of consonants/vowels or their position in the letter cluster.)

- Ans
- 1. VWZU
  - 2. EFHD
  - 3. MNQL
  - 4. OPSN

Q.16 What would be the symbol on the opposite side of '@' if the given sheet is folded to form a cube?

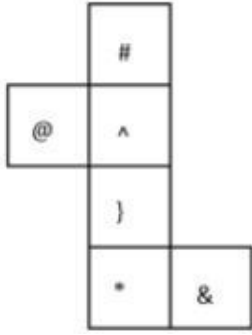

- Ans
- 1. }
  - 2. &
  - 3. #
  - 4. \*

Q.17 How many meaningful English words can be formed with letters CKIK, using each letter only once in each word?

- Ans
- 1. 1
  - 2. 4
  - 3. 2
  - 4. 3

Q.18 In a certain code language,  
A + B means 'A is the son of B'  
A - B means 'A is the brother of B'  
A × B means 'A is the wife of B'  
A ÷ B means 'A is the father of B'  
Based on the above, how is P related to T if 'P × Q - R + S ÷ T'?

- Ans
- 1. Mother
  - 2. Sister
  - 3. Brother's wife
  - 4. Brother's wife's mother

Q.19 What will come in the place of the question mark (?) in the following equation, if '+' and '-' are interchanged and '×' and '÷' are interchanged?

$$91 \times 7 + 27 - 7 \div 13 = ?$$

- Ans
- 1. 66
  - 2. 88
  - 3. 99
  - 4. 77

Q.20 Select the correct mirror image of the given combination when the mirror is placed at MN as shown below.



- Ans
- 1. RəwSd4U
  - 2. Rəw4b2U
  - 3. RəwSweR
  - 4. U4b2weR

Q.21 Select the correct mirror image of the given combination when the mirror is placed at MN as shown below.

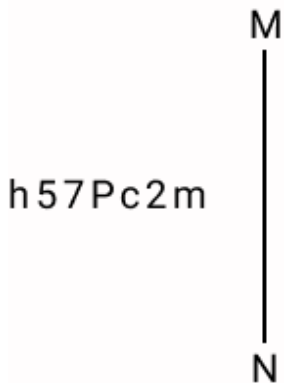

- Ans
- 1. h57Pc2m
  - 2. h2vPc2m
  - 3. h2vPc5m
  - 4. h57Pc5m

Q.22 105 is related to 15 following a certain logic. Following the same logic, 154 is related to 22. To which of the following is related 189 following the same logic?  
(NOTE : Operations should be performed on the whole numbers, without breaking down the numbers into its constituent digits. E.g. 13 – Operations on 13 such as adding /deleting /multiplying etc., to 13 can be performed. Breaking down 13 into 1 and 3 and then performing mathematical operations on 1 and 3 is not allowed.)

- Ans
- 1. 21
  - 2. 23
  - 3. 27
  - 4. 29

Q.23 In a certain language, 'this is music' is written as 'Ta Bu Ka' and 'who touched this' is written as 'Pi Ka Bi'. How is 'this' written in the given language?

- Ans
- 1. Bi
  - 2. Bu
  - 3. Ka
  - 4. Ta

Q.24 What should come in place of ? in the given series based on the English alphabetical order?

CKS LRC ? DFW MMG

- Ans
- 1. YAM
  - 2. UYM
  - 3. VMO
  - 4. HGO

Q.25 What should come in place of the question mark (?) in the given series based on the English alphabetical order?

LDP, GHO, BLN, WPM, ?

- Ans
- 1. QSM
  - 2. RTL
  - 3. RSN
  - 4. QSN

Section : Quantitative Aptitude

1. A man can row 18 km/h in still water. It takes him two times as long to row up as to row down the river. Find the rate of the stream.

- Ans
- 1. 12 km/h
  - 2. 6 km/h
  - 3. 24 km/h
  - 4. 9 km/h

Q.2 CD is a tangent to a circle of circumference of 88 cm with its centre at O. OC cuts the circle at P while OD cuts circle at V such that  $\angle COD = 90^\circ$ . Length of PC is 6 cm. What is half of CD (in cm) if OD exceeds OC by 1 cm?

- Ans
- 1. 15.5
  - 2. 14.5
  - 3. 31
  - 4. 16.5

Q.3 If 1234567y is divisible by 11, then what is the value of y?

- Ans
- 1. 3
  - 2. 1
  - 3. 4
  - 4. 2

Q.4 A and B can do a piece of work in 9 days and 15 days, respectively. If they work together, then the work will be completed in:

- Ans
- 1.  $3\frac{3}{8}$  days
  - 2.  $2\frac{1}{8}$  days
  - 3.  $5\frac{5}{8}$  days
  - 4.  $4\frac{5}{8}$  days



Q.5 If the selling price of 100 pens is equal to the cost price of 140 pens, find the profit percentage.

- Ans
- 1. 30%
  - 2. 45%
  - 3. 40%
  - 4. 36%

Q.6 If  $A : B = 3 : 7$  and  $B : C = 2 : 5$ , find  $A : B : C$ .

- Ans
- 1. 10 : 3 : 4
  - 2. 4 : 10 : 3
  - 3. 4 : 3 : 10
  - 4. 6 : 14 : 35

Q.7 The curved surface area of a cone is  $2200 \text{ cm}^2$  and its radius is 28 cm, what is the slant height (in cm) of the cone? (Use  $\pi = \frac{22}{7}$ )

- Ans
- 1. 25
  - 2. 24
  - 3. 22
  - 4. 23

Q.8 P pays Q a sum of ₹150 using coins of ₹2, ₹5 and ₹10. He uses a total of 50 coins. If the ratio of ₹2 and ₹5 coins used is 5 : 2, then how many coins of ₹10 are used in the payment?

- Ans
- 1. 1
  - 2. 4
  - 3. 5
  - 4. 2

Q.9 An amount becomes double in 7 years on simple interest. The amount would be four times in \_\_\_\_\_ years on the same rate of simple interest.

- Ans
- 1. 14
  - 2. 28
  - 3. 21
  - 4. 18

Q.10 If  $\cot A = 7$ , then the value of  $\frac{5 \cos A + 4 \sin A}{\cos^3 A + 7 \sin^3 A + 6 \sin A}$  is:

- Ans
- 1. 3
  - 2. 2
  - 3. 0
  - 4. 1

Q.11 The bar graph represents the production of different spare parts of computer in different months.

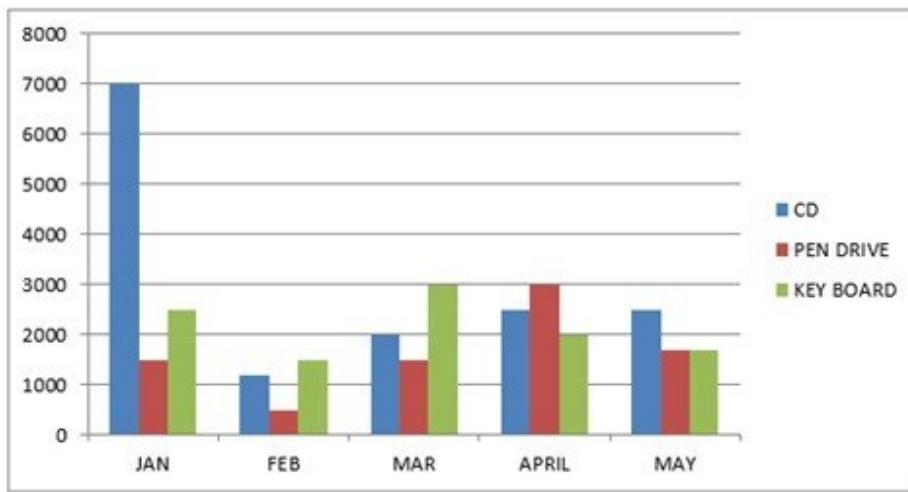

The ratio between the number of pen drives produced in the month of Jan, March and April is:

- Ans
- 1. 1 : 1 : 2
  - 2. 1 : 1 : 1
  - 3. 1 : 1 : 3
  - 4. 3 : 1 : 2

Q.12 The radius of a roller is 49 cm and its length is 200 cm. It takes 700 complete revolutions to move once over to level a playground. Find the area of the playground. (Use  $\pi = \frac{22}{7}$ .)

- Ans
- 1.  $4312 \times 10^3 \text{ cm}^2$
  - 2.  $4312 \times 10^2 \text{ cm}^2$
  - 3.  $4322 \times 10^4 \text{ cm}^2$
  - 4.  $4312 \times 10^4 \text{ cm}^2$

Q.13 Simplify:  
 $(36 \div 6) \div 3 + (18 \div 9) \times 4 - (12 \div 6) \times (5 \div 2) =$

- Ans
- 1. 10
  - 2. 5
  - 3. 21
  - 4. 15

Q.14 In an election between two candidates A and B, A got 33% of total votes casted and still lost by 55,522 votes. Find the total number of votes got by B.

- Ans
- 1. 1,09,114
  - 2. 1,09,141
  - 3. 1,04,911
  - 4. 1,09,411

Q.15 A shopkeeper gives a 10% discount and still earns 10% profit. The marked price of the item is how many times (correct to 2 decimal places) the cost price?

- Ans
- 1. 1.28
  - 2. 1.24
  - 3. 1.22
  - 4. 1.20

Q.16 The given pie-charts show the distribution of Graduate and Post-graduate level students in five different colleges A, B, C, D and E.

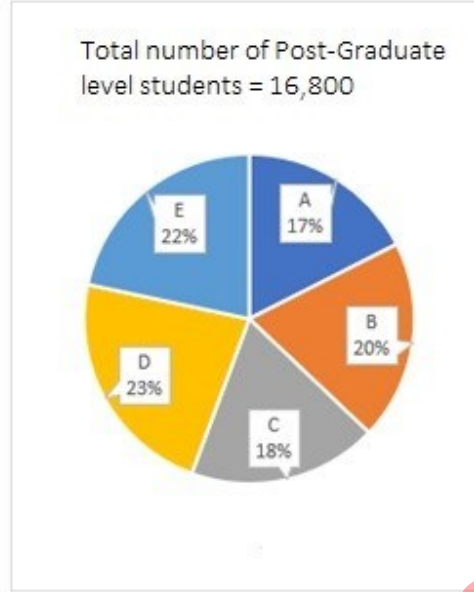
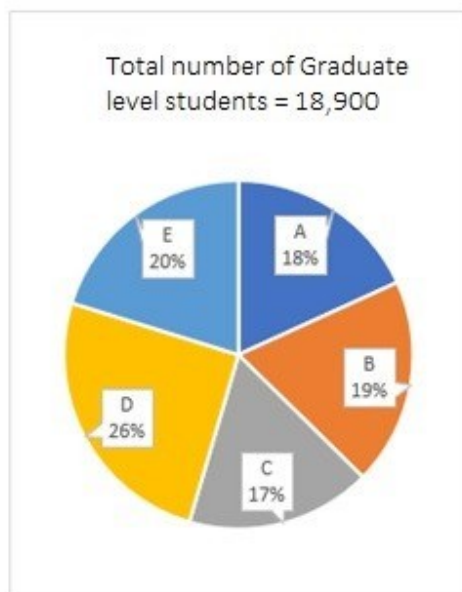

What is the ratio between the number of students studying at Post-Graduate and Graduate levels, respectively, from college E?

- Ans
- 1. 32 : 43
  - 2. 16 : 17
  - 3. 44 : 45
  - 4. 48 : 37

Q.17 Following Pie chart presents monthly expenditure by Sushma and Preeti in different heads. Sushma and Preeti make equal expenditure every month.

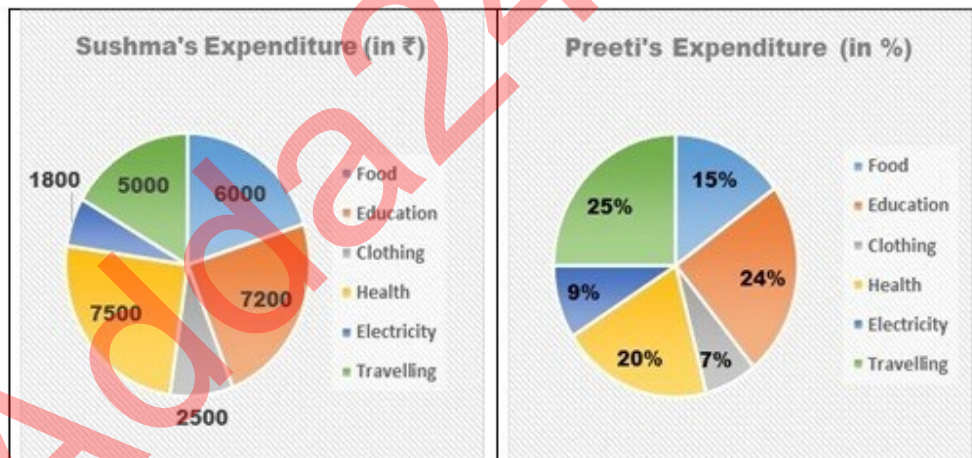

What is the difference between the expenditure (in ₹) done on Food by Sushma and Preeti?

- Ans
- 1. 1500
  - 2. 500
  - 3. 750
  - 4. 1000

Q.18

Given below is the observed data of the ages of various children.

Age in years	Number of children
6	8
7	3
8	7
9	2
10	20

What is the difference between the mean and mode of the ages?

- Ans
- 1. 4.425 years
  - 2. 2.425 years
  - 3. 1.425 years
  - 4. 3.425 years

Q.19

In a triangle ABC,  $AB = 6$  units,  $BC = 8$  units and  $AC = 10$  units. Let M be a point on AC such that  $BM = 5$  units. With a point D, a triangle BMD is formed and the triangle BMD is similar to the triangle ABC with  $\frac{BM}{AB} = \frac{BD}{AC}$ . What is the length of BD in units?

- Ans
- 1.  $\frac{35}{3}$
  - 2.  $\frac{40}{3}$
  - 3.  $\frac{25}{3}$
  - 4.  $\frac{10}{3}$

Q.20 If the radii of two circles are 6 cm and 3 cm and the length of the transverse common tangent is 8 cm, then the distance between the two circles is:

- Ans
- 1.  $\sqrt{145}$
  - 2.  $\sqrt{141}$
  - 3.  $\sqrt{147}$
  - 4.  $\sqrt{143}$

Q.21 In what ratio must a grocer mix two varieties of pulses costing ₹60 and ₹75 per kg, respectively, so as to get a mixture worth ₹65 per kg?

- Ans
- 1. 3 : 4
  - 2. 2 : 1
  - 3. 2 : 3
  - 4. 1 : 2

Q.22 In an isosceles triangle, the angle between equal sides is  $40^\circ$ . The bisectors of the other two angles will intersect each other at an angle of:

- Ans
- 1.  $100^\circ$
  - 2.  $105^\circ$
  - 3.  $120^\circ$
  - 4.  $110^\circ$

Q.23 If the price of an article is raised by 35%, by how much per cent must a householder reduce his consumption of that article, so as not to increase his expenditure?

- Ans
- 1.  $25\frac{22}{27}\%$
  - 2.  $25\frac{23}{27}\%$
  - 3.  $25\frac{25}{27}\%$
  - 4.  $25\frac{24}{27}\%$

Q.24 The cost price of an item increased from ₹2,500 to ₹3,000. Find the increase percentage.

- Ans
- 1. 25%
  - 2. 20%
  - 3. 30%
  - 4. 15%

Q.25 Find the circumference of a circle whose area is  $154\text{ m}^2$ .

- Ans
- 1. 44 m
  - 2. 29.5 m
  - 3. 39 m
  - 4. 52 m

Section : General Awareness

1. Which country do the 'Veddas' traditional forest dwellers who foraged, hunted and lived in close-knit groups in caves in the dense jungles?

- Ans
- 1. Myanmar
  - 2. Nepal
  - 3. Bhutan
  - 4. Sri Lanka

2. Which folk music is based on the Mahabharata with Bhima portrayed as hero?

- Ans
- 1. Mando
  - 2. Alha
  - 3. Pandavani
  - 4. Dandiya

3. Which amongst the following terms was used for the land given to Brahmins during the Chola empire?

- Ans
- 1. Tirunmatukkani
  - 2. Shalabhoga
  - 3. Vellanvagai
  - 4. Brahmadeya

Q.4 How might ICT enhance the openness of e-land records?

- Ans
- 1. Enabling quick search and retrieval of land records
  - 2. Enforcing strict regulations on land transactions
  - 3. Facilitating manual record updates and amendments
  - 4. Reducing the need for land surveys and assessments

Q.5 Which of the following Articles of the Constitution of India CANNOT be amended with simple majority?

- Ans
- 1. 21
  - 2. 3
  - 3. 2
  - 4. 169

Q.6 In his 'Drain of Wealth' argument, who among the following stated that Britain was completely draining India?

- Ans
- 1. Lala Lajpat Rai
  - 2. Dadabhai Naoroji
  - 3. Bal Gangadhar Tilak
  - 4. Badruddin Tyabji

Q.7 How is the structure of health infrastructure and health care system in India?

- Ans
- 1. Three-tier system
  - 2. Four-tier system
  - 3. Five-tier system
  - 4. Two-tier system

Q.8 In which year did Indian archers participate in the Olympics for the first time?

- Ans
- 1. 1988
  - 2. 1973
  - 3. 1980
  - 4. 1975

Q.9 Which language is known as 'Italian of the East'?

- Ans
- 1. Malayalam
  - 2. Kannada
  - 3. Marathi
  - 4. Telugu

Q.10 Which of the following states launched the first Migration Monitoring System in the year 2022?

- Ans
- 1. Karnataka
  - 2. Goa
  - 3. Maharashtra
  - 4. Kerala

Q.11 As compared to monopolistic competition, the demand curve in a monopoly is:

- Ans
- 1. infinitely elastic
  - 2. equally elastic
  - 3. more elastic
  - 4. less elastic

Q.12 Which group of animals has a segmented spinal column together with a few primitive forms in which the backbone is represented by a notochord?

- Ans
- 1. Arthropoda
  - 2. Echinodermata
  - 3. Mollusca
  - 4. Vertebrata

Q.13 The Indian festival of Holi comes every year in the season of:

- Ans
- 1. spring
  - 2. autumn
  - 3. summer
  - 4. winter

Q.14 Who is the author of Natyashastra?

- Ans
- 1. Bharatmuni
  - 2. Patanjali
  - 3. Prabhupada
  - 4. Panini

Q.15 What is the circumference of the International Football Association Board (IFAB) approved football?

- Ans
- 1. 80 - 82 cms
  - 2. 78 - 80 cms
  - 3. 68 - 70 cms
  - 4. 70 - 72 cms

Q.16 In field hockey, \_\_\_\_\_ occurs when a player pushes the ball and raises it off the ground.

- Ans
- 1. flick
  - 2. centre pass
  - 3. slap
  - 4. bully

Q.17 What is the name of the highest peak of the Eastern Ghats?

- Ans
- 1. Khasi
  - 2. Anamudi
  - 3. Mahendragiri
  - 4. Kangchenjunga

Q.18 In MS Word, which option allows you to align text in a way that it appears vertically at the bottom of a cell or text box?

- Ans
- 1. Distributed Alignment
  - 2. Justify Alignment
  - 3. Center Alignment
  - 4. Bottom Alignment

Q.19 Which of the following is NOT associated with the Industrial Policy Resolution, 1956?

- Ans
- 1. Regional equality was promoted.
  - 2. It formed the basis of the Third Five Year Plan.
  - 3. A system of licenses for the private sector was introduced.
  - 4. It classified industries into three categories.

Q.20 Which of the following planets does NOT have a ring around it?

- Ans
- 1. Jupiter
  - 2. Saturn
  - 3. Uranus
  - 4. Mercury

Q.21 Writ of Mandamus is a Fundamental Right classifiable under:

- Ans
- 1. the right to equality
  - 2. cultural and educational rights
  - 3. constitutional remedies
  - 4. the right to freedom of religion

Q.22 In 2022, the National Green Tribunal advised which of the following Ministries to form a three-member panel to formulate safeguards and guidelines to be followed by the State Environment Impact Assessment Authorities?

- Ans
- 1. Ministry of Environment, Forest and Climate Change
  - 2. Ministry of Health and Family Welfare
  - 3. Ministry of Law and Justice
  - 4. Ministry of Home Affairs

Q.23 \_\_\_\_\_ was sworn in as Central Vigilance Commissioner on 29 May 2023.

- Ans
- 1. Uday Veer Singh
  - 2. Praveen Kumar Srivastava
  - 3. Arti C Srivastava
  - 4. Sarvan Kumar

Q.24 Who is known as the 'Father of Carnatic Music'?

- Ans
- 1. Thirunal Rama Varma
  - 2. Vishwanath Iyer
  - 3. Vidyaranya
  - 4. Purandara Dasa

Q.25 The method of separating a mixture of soluble solids by dissolving them in a suitable hot solvent and then lowering the temperature slowly is called:

- Ans
- 1. fractional crystallisation
  - 2. dephlegmation
  - 3. azeotropic distillation
  - 4. sublimation



## Combined Higher Secondary Level Examination 2024 Tier I

Exam Date	01/07/2024
Exam Time	5:15 PM - 6:15 PM
Subject	CHSL Exam 2024 Tier I

### Section : English Language

1. Select the option with the correct use of present tense.

- Ans
- 1. She spended all her money on make-up in order to look beautiful.
  - 2. She had spend all her money on make-up in order to look beautiful.
  - 3. She spends all her money on make-up in order to look beautiful.
  - 4. She has spend all her money on make-up in order to look beautiful.

2. The given sentence is divided into four segments. Identify the segment that contains a grammatical error. When it / come to football, / my brother is / an addict.

- Ans
- 1. come to football,
  - 2. an addict.
  - 3. my brother is
  - 4. When it

3. The following sentence has been divided into four segments. Identify the segment that contains an error.

Throw of / the old shoes; / nobody will wear / them now.

- Ans
- 1. them now.
  - 2. nobody will wear
  - 3. the old shoes;
  - 4. Throw of

Q.4 Select the option with the correct use of article(s).

- Ans
- 1. I was rude to him when I was in an fit of rage.
  - 2. I was rude to him when I was in fit of rage.
  - 3. I was rude to him when I was in the fit of rage.
  - 4. I was rude to him when I was in a fit of rage.

**Comprehension:**

In the following passage, some words have been deleted. Read the passage carefully and select the most appropriate option to fill in each blank.

During the days of slavery, there lived (1)\_\_\_\_\_very hard-working slave. One day, (2)\_\_\_\_\_freedom, he ran away from his masters house. As he passed a forest, he saw a lion (3)\_\_\_\_\_with pain, for a huge thorn had pierced its paw. The slave felt sorry for the lion and took out the thorn gently. The grateful lion licked the slaves hand. But just then, both of (4)\_\_\_\_\_were captured by the soldiers. The king ordered, "Let the runaway slave (5)\_\_\_\_\_thrown in front of a hungry lion." But, when the slave was thrown in front of the lion, the lion licked him and quietly sat beside him. The amazed king asked the reason. The slave told the king everything. The king pardoned the slave. The lion was also freed and sent to the forest.

**SubQuestion No : 5**

**Q.5** Select the most appropriate option to fill in blank number 1.

- Ans**
- 1. the
  - 2. a
  - 3. an
  - 4. two

**Comprehension:**

In the following passage, some words have been deleted. Read the passage carefully and select the most appropriate option to fill in each blank.

During the days of slavery, there lived (1)\_\_\_\_\_very hard-working slave. One day, (2)\_\_\_\_\_freedom, he ran away from his masters house. As he passed a forest, he saw a lion (3)\_\_\_\_\_with pain, for a huge thorn had pierced its paw. The slave felt sorry for the lion and took out the thorn gently. The grateful lion licked the slaves hand. But just then, both of (4)\_\_\_\_\_were captured by the soldiers. The king ordered, "Let the runaway slave (5)\_\_\_\_\_thrown in front of a hungry lion." But, when the slave was thrown in front of the lion, the lion licked him and quietly sat beside him. The amazed king asked the reason. The slave told the king everything. The king pardoned the slave. The lion was also freed and sent to the forest.

**SubQuestion No : 6**

**Q.6** Select the most appropriate option to fill in blank number 2.

- Ans**
- 1. gain
  - 2. gains
  - 3. to gain
  - 4. gained

**Comprehension:**

In the following passage, some words have been deleted. Read the passage carefully and select the most appropriate option to fill in each blank.

During the days of slavery, there lived (1)\_\_\_\_\_very hard-working slave. One day, (2)\_\_\_\_\_freedom, he ran away from his masters house. As he passed a forest, he saw a lion (3)\_\_\_\_\_with pain, for a huge thorn had pierced its paw. The slave felt sorry for the lion and took out the thorn gently. The grateful lion licked the slaves hand. But just then, both of (4)\_\_\_\_\_were captured by the soldiers. The king ordered, "Let the runaway slave (5)\_\_\_\_\_thrown in front of a hungry lion." But, when the slave was thrown in front of the lion, the lion licked him and quietly sat beside him. The amazed king asked the reason. The slave told the king everything. The king pardoned the slave. The lion was also freed and sent to the forest.

**SubQuestion No : 7**

**Q.7** Select the most appropriate option to fill in blank number 3.

- Ans**
- 1. roars
  - 2. roared
  - 3. roar
  - 4. roaring

**Comprehension:**

In the following passage, some words have been deleted. Read the passage carefully and select the most appropriate option to fill in each blank.

During the days of slavery, there lived (1)\_\_\_\_\_very hard-working slave. One day, (2)\_\_\_\_\_freedom, he ran away from his masters house. As he passed a forest, he saw a lion (3)\_\_\_\_\_with pain, for a huge thorn had pierced its paw. The slave felt sorry for the lion and took out the thorn gently. The grateful lion licked the slaves hand. But just then, both of (4)\_\_\_\_\_were captured by the soldiers. The king ordered, "Let the runaway slave (5)\_\_\_\_\_thrown in front of a hungry lion." But, when the slave was thrown in front of the lion, the lion licked him and quietly sat beside him. The amazed king asked the reason. The slave told the king everything. The king pardoned the slave. The lion was also freed and sent to the forest.

**SubQuestion No : 8**

**Q.8** Select the most appropriate option to fill in blank number 4.

- Ans
- 1. her
  - 2. him
  - 3. us
  - 4. them

**Comprehension:**

In the following passage, some words have been deleted. Read the passage carefully and select the most appropriate option to fill in each blank.

During the days of slavery, there lived (1)\_\_\_\_\_very hard-working slave. One day, (2)\_\_\_\_\_freedom, he ran away from his masters house. As he passed a forest, he saw a lion (3)\_\_\_\_\_with pain, for a huge thorn had pierced its paw. The slave felt sorry for the lion and took out the thorn gently. The grateful lion licked the slaves hand. But just then, both of (4)\_\_\_\_\_were captured by the soldiers. The king ordered, "Let the runaway slave (5)\_\_\_\_\_thrown in front of a hungry lion." But, when the slave was thrown in front of the lion, the lion licked him and quietly sat beside him. The amazed king asked the reason. The slave told the king everything. The king pardoned the slave. The lion was also freed and sent to the forest.

**SubQuestion No : 9**

**Q.9** Select the most appropriate option to fill in blank number 5.

- Ans
- 1. been
  - 2. being
  - 3. be
  - 4. is

**Q.10** Identify the most appropriate ANTONYM of the underlined word in the following sentence.

A boisterous horse must have a rough bridle.

- Ans
- 1. Rowdy
  - 2. Loud
  - 3. Bouncy
  - 4. Calm

**Q.11** Select the most appropriate option that can substitute the underlined segment in the given sentence. If there is no need to substitute it, select 'No improvement required'.

I am so glad that I ran into you on the way.

- Ans
- 1. ran over
  - 2. No improvement required
  - 3. ran away
  - 4. ran out of

**Q.12** Select the most appropriate ANTONYM of the given word.  
Stingy

- Ans
- 1. Generous
  - 2. Humorous
  - 3. Lascivious
  - 4. Deceitful

Q.13 Select the most appropriate idiom for the underlined segment in the following sentence.  
The arrival of Pragati in the house brought disharmony among the family members.

- Ans
- 1. Tenterhooks
  - 2. A cry in the wilderness
  - 3. Rift in the lute
  - 4. Hair breadth

Q.14 Select the most appropriate synonym of the given word.  
Titanic

- Ans
- 1. Deep
  - 2. Huge
  - 3. Attractive
  - 4. Disastrous

Q.15 Select the most appropriate ANTONYM of the underlined word in the given sentence.  
Prajakta is a very vain girl.

- Ans
- 1. Honourable
  - 2. Humble
  - 3. Honest
  - 4. Hopeful

Q.16 Select the most appropriate ANTONYM of the underlined word in the given sentence.  
Ralph's condition worsened in the hospital.

- Ans
- 1. Improved
  - 2. Scaled
  - 3. Changed
  - 4. Traversed

Q.17 Select the option that will improve the underlined part of the given sentence.

This win could enhance to be a historic turning point in the fortunes of the team.

- Ans
- 1. prove
  - 2. demonstrate
  - 3. accomplish
  - 4. confirm

Q.18 Select the most appropriate synonym of the given word.

Fasten

- Ans
- 1. Loosen
  - 2. Bolt
  - 3. Undo
  - 4. Detach

Q.19 There is a spelling error in the given sentence. Select the option that contains the INCORRECTLY spelt word.  
The precious bookshelf was carefully decorated with religiuous books.

- Ans
- 1. precious
  - 2. decorated
  - 3. carefully
  - 4. religiuos

**Q.20** Identify the INCORRECTLY spelt word in the following sentence and select its correct spelling from the given options.  
The committee heard that he had been negligent in his duty.

- Ans**
- 1. negligent
  - 2. dutie
  - 3. comittee
  - 4. hurd

**Q.21** Select the option that will improve the underlined part of the given sentence.

Mothers have great animosity for their children.

- Ans**
- 1. affection
  - 2. absurdity
  - 3. affectation
  - 4. abasement

**Q.22** Select the most appropriate option to fill in the blank.  
The CEO's decision to cut benefits was a \_\_\_\_\_ move.

- Ans**
- 1. harsh
  - 2. humorous
  - 3. rigorous
  - 4. laborious

**Q.23** Select the most appropriate option that can substitute the underlined segment in the given sentence.  
Sonam's cat used to chase the mouse into the kitchen and knock through a tower of pots and pans.

- Ans**
- 1. knock inside a tower of pots
  - 2. knock over a tower of pots
  - 3. knock away a tower of pots
  - 4. knock out a tower of pots

**Q.24** Select the most appropriate ANTONYM of the underlined word in the given sentence.  
The organisation's furtive actions must be taken into notice and dealt with accordingly.

- Ans**
- 1. Futuristic
  - 2. Truthful
  - 3. Shady
  - 4. Foxy

**Q.25** Select the most appropriate meaning of the given idiom.  
Cost an arm and a leg

- Ans**
- 1. To be moderately priced
  - 2. To be inexpensive
  - 3. To be very expensive
  - 4. To be affordable

Q.1 Select the correct mirror image of the given combination when the mirror is placed at MN as shown below.

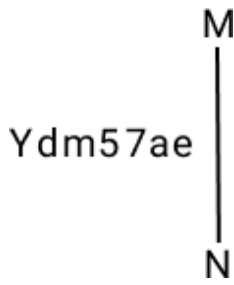

- Ans
- 1. eε∇ɔmbY
  - 2. eε57mbY
  - 3. eε∇ɔdmY
  - 4. Ydm57ae

Q.2 What should come in place of ? in the given series based on the English alphabetical order?

DLT ZHP VDL ? NVD

- Ans
- 1. DNX
  - 2. RZH
  - 3. CMW
  - 4. BLV

Q.3 What would be the symbol on the opposite side of '@' if the given sheet is folded to form a cube?

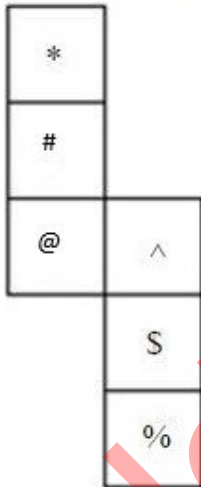

- Ans
- 1. S
  - 2. \*
  - 3. %
  - 4. ^

Q.4 In a certain code language, 'I am boy' is coded as 'it sit pit' and 'I am girl' is coded as 'sit nit it'. What is the code for 'girl' in that language?

- Ans
- 1. it
  - 2. nit
  - 3. pit
  - 4. sit

Q.5 What should come in place of the question mark (?) in the given series?

4, 20, 100, 500, 2500, ?

- Ans
- 1. 12200
  - 2. 12700
  - 3. 12600
  - 4. 12500

Q.6 Select the correct mirror image of the given combination when the mirror is placed at MN as shown below.

M  
|  
Dr72mhe  
|  
N

- Ans
- 1. ehm27rD
  - 2. eh27mDr
  - 3. eh72mDr
  - 4. Dr27mhe

Q.7 What will come in the place of the question mark (?) in the following equation, if '+' and '-' are interchanged and '×' and '÷' are interchanged?

$$209 \div 2 + 14 - 120 \times 3 = ?$$

- Ans
- 1. 412
  - 2. 454
  - 3. 434
  - 4. 444

Q.8 Select the option figure in which the given figure (X) is embedded as its part (rotation is NOT allowed).

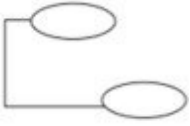

(X)

Ans

✓ 1.

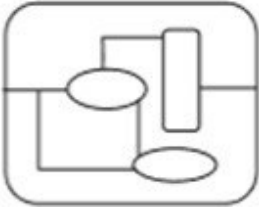

✗ 2.

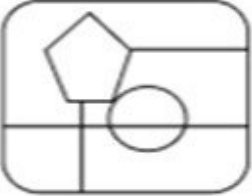

✗ 3.

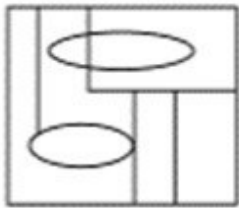

✗ 4.



Q.9 Select the option that is related to the third number in the same way as the second number is related to the first number and the sixth number is related to the fifth number.  
 $64 : 512 :: 169 : ? :: 225 : 3375$

Ans

✓ 1. 2197

✗ 2. 872

✗ 3. 1852

✗ 4. 1026



Q.10 Identify the figure given in the options that when put in place of the question mark (?) will logically complete the series.

D	2	K	X	O	V	V	X	O	K	D	2	
V	O	X	K	2	D	2	D	K	O	X	V	?

Ans

✗ 1.

D	2	K
X	V	O

✗ 2.

2	K	D
V	O	X

✓ 3.

2	K	D
X	V	O

✗ 4.

D	2	K
V	O	X

Q.11 Read the given statements and conclusions carefully. Assuming that the information given in the statements is true, even if it appears to be at variance with commonly known facts, decide which of the given conclusions logically follow(s) from the statements.

Statements:

All watches are dials.

All dials are phones.

Some phones are mobiles.

Conclusions:

(I) No watch is a phone.

(II) Some dials are mobiles.

Ans

✓ 1. None of the conclusions follow

✗ 2. Only conclusion II follows

✗ 3. Only conclusion I follows

✗ 4. Both conclusions I and II follow

Q.12 In a certain code language,  
'M & N' means 'M is the father of N',  
'M@N' means 'M is the daughter of N',  
'M#N' means 'M is the brother of N',  
'M % N' means 'M is the mother of N'.  
Based on this, how is A related to E, if 'A & B # C @ D % E'?

- Ans
- 1. Father's brother
  - 2. Father
  - 3. Son
  - 4. Brother

Q.13 Select the combination of letters that when sequentially placed in the blanks of the given series will complete the series.  
\_ n p \_ r r \_ p \_ m m \_ p q \_ r q \_ n m \_ n p \_ r r q \_ n m

- Ans
- 1. mqqnrmpmq
  - 2. mrqnnrmpqp
  - 3. mqqnrmpmq
  - 4. mqqrnpmqp

Q.14 If 1 January 2020 was a Wednesday, then what day of the week was it on 1 January 2021?

- Ans
- 1. Thursday
  - 2. Wednesday
  - 3. Tuesday
  - 4. Friday

Q.15 What should come in place of '?' in the given series?

21 60 177 528 1581 ?

- Ans
- 1. 4636
  - 2. 4740
  - 3. 4892
  - 4. 4570

Q.16 FHGE is related to IKJH in a certain way based on the English alphabetical order. In the same way, HJIG is related to KMLJ. To which of the following is RTSQ related, following the same logic?

- Ans
- 1. UVWT
  - 2. VWUT
  - 3. UWVT
  - 4. TVUS

Q.17 CZ22 is related to HE33 in a certain way. In the same way, QN47 is related to VS58. To which of the following is WT7 related following the same logic?

- Ans
- 1. GA21
  - 2. BY21
  - 3. BY18
  - 4. GA18

Q.18 In a certain language, 'make someone happy' is written as 'Ab Te Dp' and 'someone robbed him' is written as 'Te Ko Vi'. How is 'someone' written in the given language?

- Ans
- 1. Vi
  - 2. Te
  - 3. Ab
  - 4. Ko

Q.19 If 'A' stands for '+', 'B' stands for '×', 'C' stands for '+' and 'D' stands for '-', then the resultant of which of the following will be 217?

- Ans
- ✓ 1. 32 B 5 D 10 A 2 C 62
  - ✗ 2. 32 A 5 D 10 B 2 C 62
  - ✗ 3. 32 B 5 D 10 C 2 A 62
  - ✗ 4. 32 D 5 B 10 A 2 C 62

Q.20 Three of the following four are alike in a certain way and thus form a group. Which is the one that does NOT belong to that group?  
(Note: The odd one out is not based on the number of consonants/vowels or their position in the letter cluster.)

- Ans
- ✓ 1. JMP
  - ✗ 2. SVZ
  - ✗ 3. BEI
  - ✗ 4. KNR

Q.21 Select the correct mirror image of the given figure when the mirror is placed at MN as shown below.

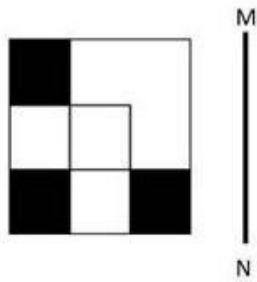

Ans

- ✓ 1.
- ✗ 2.
- ✗ 3.
- ✗ 4.

Q.22 The position of how many letters will change if each of the letters in the word TROUBLEMAKING is arranged from left to right in alphabetical order?

- Ans
- 1. Twelve
  - 2. All
  - 3. Ten
  - 4. Eleven

Q.23 Select the set in which the numbers are related in the same way as are the numbers of the following sets.  
(NOTE : Operations should be performed on the whole numbers, without breaking down the numbers into its constituent digits. E.g. 13 – Operations on 13 such as adding /subtracting /multiplying etc. to 13 can be performed. Breaking down 13 into 1 and 3 and then performing mathematical operations on 1 and 3 is not allowed)

(59, 83, 97)

(63, 87, 101)

- Ans
- 1. (67, 91, 115)
  - 2. (71, 95, 109)
  - 3. (51, 65, 89)
  - 4. (48, 82, 96)

Q.24 What will come in the place of '?' in the following equation, if '×' and '÷' are interchanged?

$$18 - 2 + 12 \times 4 \div 7 = ?$$

- Ans
- 1. 30
  - 2. 37
  - 3. 49
  - 4. 45

Q.25 How many triangles are there in the given figure?

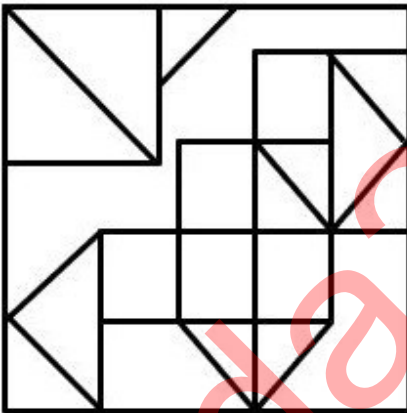

- Ans
- 1. 11
  - 2. 15
  - 3. 12
  - 4. 13

Q.1 Given is a circle with centre at C. A, B and D are the points on the circumference. Find  $\angle ABC$ .

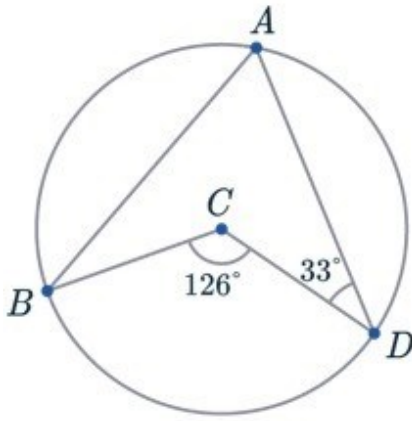

- Ans
- 1.  $30^\circ$
  - 2.  $37^\circ$
  - 3.  $35^\circ$
  - 4.  $33^\circ$

Q.2 A robber steals a bag from a man at 5 p.m. and starts running at 10 km/h. A policeman is informed about the robber at 5:12 p.m. and he chases him on a cycle at 15 km/h. At what time is the robber caught by the policeman?

- Ans
- 1. 5:48 p.m.
  - 2. 5:36 p.m.
  - 3. 5:12 p.m.
  - 4. 5:40 p.m.

Q.3 Fifteen persons working 12 hours a day earn ₹18,000 per week. How many rupees will 18 persons working 9 hours a day earn per week?

- Ans
- 1. ₹16,020
  - 2. ₹12,600
  - 3. ₹12,060
  - 4. ₹16,200

Q.4 Answer the following question on the basis of the bar graph given.

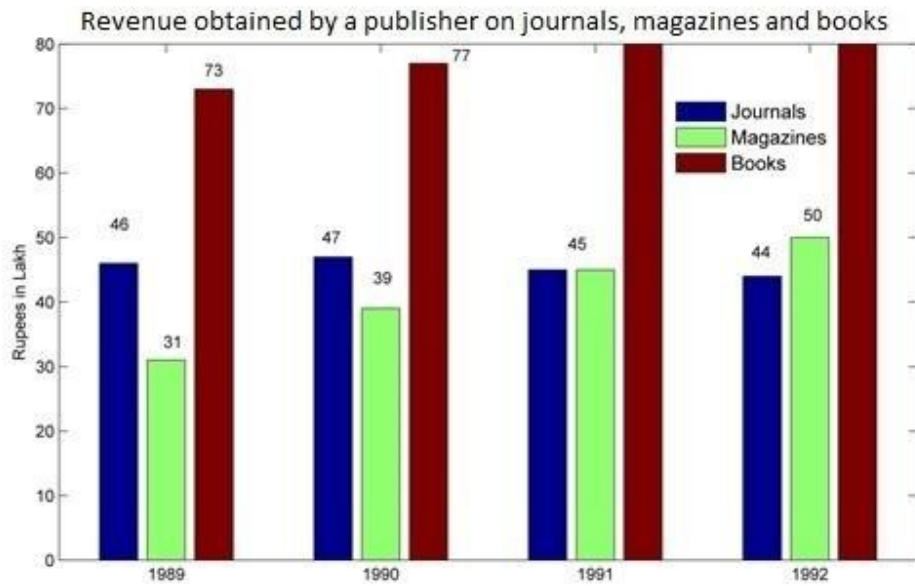

Which year shows the highest change in the revenue obtained from magazines?

- Ans
- 1. 1991
  - 2. 1992
  - 3. 1990
  - 4. 1989

Q.5 If the selling price of 40 articles is equal to the cost price of 50 articles, then the percentage gain is:

- Ans
- 1. 25%
  - 2. 20%
  - 3. 30%
  - 4. 35%

Q.6 The surface area of a sphere is  $2464 \text{ cm}^2$ . Find its volume.

- Ans
- 1.  $13121\frac{1}{3} \text{ cm}^3$
  - 2.  $11892\frac{2}{3} \text{ cm}^3$
  - 3.  $11498\frac{2}{3} \text{ cm}^3$
  - 4.  $11621\frac{1}{3} \text{ cm}^3$

Q.7 The following graph shows the production of milk in 4 states in 2010 and 2011.

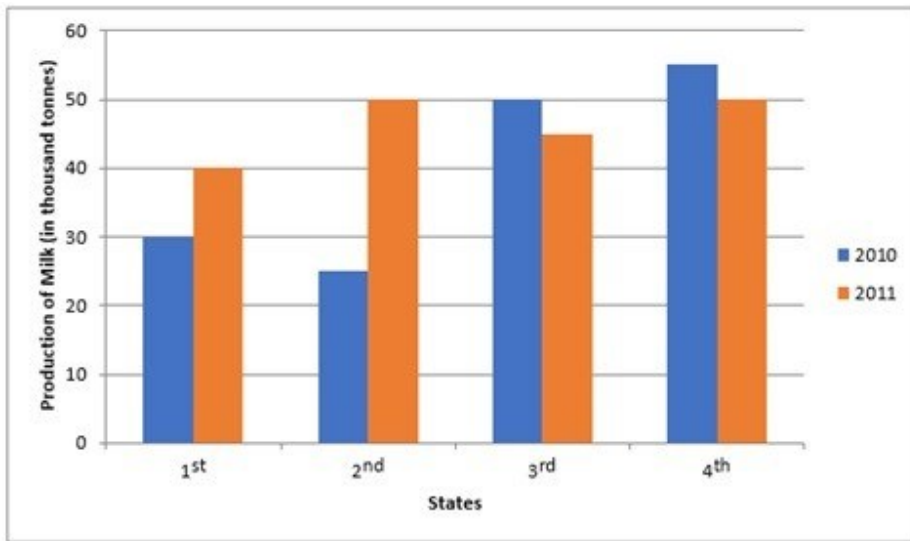

The difference between the average production (in thousand tonnes) for all state in both years

- is: Ans
- 1. 6.25
  - 2. 6.75
  - 3. 7.75
  - 4. 7.25

Q.8 The difference between two numbers is 48. The ratio of these two numbers is 7 : 3. What is the sum of the two numbers?

- Ans
- 1. 110
  - 2. 90
  - 3. 100
  - 4. 120

Q.9

Study the given table and answer the question that follows.

The table shows the results of half-yearly and annual examinations of three sections A, B, C of class X students in a school.

Result	Number of students		
	Section A	Section B	Section C
Students failed in both exams	39	20	12
Students failed in half-yearly but passed in annual exams	16	14	6
Students passed in half-yearly but failed in annual exams	10	12	8
Students passed in both exams	65	45	35

Find the failed percentage of section C in at least one of the two examinations.

- Ans
- 1. 30.81%
  - 2. 10.42%
  - 3. 38.23%
  - 4. 42.62%

Q.10 The population of a city was 5000000 in 2020. The population grows 7.5% annually. The population in 2022 is \_\_\_\_\_.

- Ans
- 1. 5778125
  - 2. 5875215
  - 3. 5558875
  - 4. 5887125

Q.11 In an election, a candidate secured 41% of the votes polled and lost the election by 97,632. What is the number of votes obtained by the winning candidate?

- Ans
- 1. 320016
  - 2. 542400
  - 3. 222384
  - 4. 360072

Q.12 There are 12 workers in an office and the average age of all the workers is  $35\frac{1}{2}$  years. A new worker joins the office, the average becomes 37 years. The current age of the newly joined worker is:

- Ans
- 1.  $55\frac{1}{2}$  years
  - 2.  $57\frac{1}{2}$  years
  - 3.  $47\frac{1}{2}$  years
  - 4. 55 years



Q.13 If the side of a cube is 3, which of the following options is equal to the ratio between the surface area and the volume of the cube?

- Ans
- 1. 2:5
  - 2. 2:7
  - 3. 2:1
  - 4. 2:3

Q.14 M varies inversely as  $(N^2 + 3)$ . If  $M = 3$  when  $N = 3$ , then what will be the value of M when  $N^2 = 69$ ?

- Ans
- 1.  $\frac{1}{2}$
  - 2. 1
  - 3.  $\sqrt{69}$
  - 4.  $\frac{1}{4}$

Q.15  $12 \sin^2 A + 2 \cos^2 A = 7$ , where  $0 < A < 180^\circ$ . Then  $\cot A$  is:

- Ans
- 1.  $\pm 1$
  - 2.  $\pm \frac{1}{2}$
  - 3.  $\pm \frac{1}{\sqrt{2}}$
  - 4.  $\pm \frac{1}{\sqrt{3}}$

Q.16 Diagonals of a trapezium ABCD with  $AB \parallel DC$ , intersect each other at the point 'O'. If  $AB = 2.5CD$ , find the ratio of the area of triangle AOB to the area of triangle COD.

- Ans
- 1. 25:4
  - 2. 16:1
  - 3. 5:2
  - 4. 9:2

Q.17 Which of the following are the sides of a right-angled triangle?

- Ans
- 1. 6 cm, 7 cm, 10 cm
  - 2. 5 cm, 11 cm, 13 cm
  - 3. 12 cm, 16 cm, 20 cm
  - 4. 16 cm, 31 cm, 34 cm

Q.18 One company is offering a 25% discount on a particular product. Anurag visited a store. He was trying to find a deal that would allow him to save at least ₹390. How many minimum items should he purchase if each item costs ₹340?

- Ans
- 1. 7
  - 2. 4
  - 3. 6
  - 4. 5

Q.19 Find the lowest positive value of  $(c - b)$  such that the 7-digit number 1738b9c is divisible by

12. Ans  1. 4  
 2. 2  
 3. 1  
 4. 7

Q.20 The simple interest on the sum for 12 years is three-fifth of the sum. The rate of interest per annum is:

- Ans  1. 4%  
 2. 6%  
 3. 5%  
 4. 3%

Q.21 Sumit's income in 2020 was ₹21,000. He gets an increment of 10% every year. What was his income in 2022?

- Ans  1. ₹23,100  
 2. ₹25,410  
 3. ₹29,100  
 4. ₹26,530

Q.22 Successive division of a number by 2, 3, 5 and 7 gives remainders 1,4,0 and 5, respectively. What will be the sum of the remainders if the same number is divided by 7, 5,3 and 2 successively?

- Ans  1. 8  
 2. 9  
 3. 10  
 4. 17

Q.23 The following graph shows the production (in thousands) of two types (A and B) of cars by a company over the years 2016 to 2021.

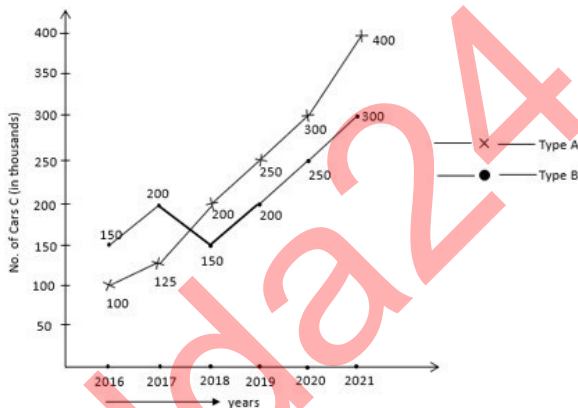

The ratio of the total production of type A cars to type B cars over the years is:

- Ans  1. 11 : 10  
 2. 21 : 10  
 3. 10 : 21  
 4. 10 : 11

Q.24 Two circles of radius 7 units each, intersect in such a way that the common chord is of length 7 units. What is the common area in square units of the intersection?

Ans

1.  $98\left(\frac{\pi}{6} - \frac{\sqrt{3}}{3}\right)$

2.  $98\left(\frac{\pi}{3} - \frac{\sqrt{3}}{4}\right)$

3.  $98\left(\frac{\pi}{6} - \frac{\sqrt{3}}{6}\right)$

4.  $98\left(\frac{\pi}{6} - \frac{\sqrt{3}}{4}\right)$

Q.25 Find the diameter of a spherical ball whose volume is  $38.808 \text{ cm}^3$ . (Use  $\pi = \frac{22}{7}$ )

Ans

1. 4.2 cm

2. 4.8 cm

3. 4.6 cm

4. 4.4 cm

Section : General Awareness

1. Folk songs in \_\_\_\_\_ are called Raganis.

Ans  1. Uttar Pradesh

2. Madhya Pradesh

3. Haryana

4. Bihar

2. Mayadhar Raut is an exponent of the Indian classical dance form \_\_\_\_\_.

Ans  1. Kuchipudi

2. Odissi

3. Bharatnatyam

4. Kathak

3. Symmetric encryption is also known as:

Ans  1. hybrid encryption

2. public-key encryption

3. asymmetric encryption

4. conventional encryption

Q.4 Mewar festival is celebrated during the \_\_\_\_\_ festival at Udaipur

Ans  1. Gangaur

2. Teej

3. Dusshera

4. Holi

Q.5 Which of the following Articles prohibits traffic in human beings and forced labour?

Ans  1. Article 25

2. Article 28

3. Article 23

4. Article 22

Q.6 If there is a fall in the demand of a good, the equilibrium price is expected to:

- Ans
- 1. fall
  - 2. neither fall nor rise
  - 3. Rise
  - 4. first rise, and then fall sharply

Q.7 In which event at the 2023 U-20 Asian Athletics Championships did Siddharth Choudhary win a gold medal for India?

- Ans
- 1. Discus throw
  - 2. Hammer throw
  - 3. Triple jump
  - 4. Shot put

Q.8 The zone separating the troposphere from the stratosphere is called the \_\_\_\_\_.

- Ans
- 1. Stratomerge
  - 2. Tropopause
  - 3. Tropomerge
  - 4. stratospause

Q.9 Which technology is associated with providing high-speed wireless data transmission for mobile devices?

- Ans
- 1. GPRS
  - 2. GPS
  - 3. Wi-Max
  - 4. LTE

Q.10 Of the football clubs listed below, which is the oldest in India?

- Ans
- 1. Calcutta FC
  - 2. Bombay FC
  - 3. Madras FC
  - 4. FC Kochin

Q.11 In January 2023, Captain Shiva Chouhan was in the news for being the first women officer to be deployed at which battlefield?

- Ans
- 1. Leh
  - 2. Kargil
  - 3. Dras
  - 4. Siachen

Q.12 Mendel proposed the law of independent assortment on the basis of \_\_\_\_\_.

- Ans
- 1. genes
  - 2. dihybrid crosses
  - 3. alleles
  - 4. Monohybrid crosses

Q.13 Which sub-division of Himalayas are famous for Karewa formations?

- Ans
- 1. Uttarakhand Himalayas
  - 2. Kashmir Himalayas
  - 3. Arunachal Himalayas
  - 4. Sikkim Himalayas

Q.14 After independence, the Census Act was enacted in India in the year \_\_\_\_\_.

- Ans
- 1. 1960
  - 2. 1955
  - 3. 1962
  - 4. 1948

Q.15 Who wrote the Indian patriotic song, 'Sare Jahan se acchha, Hindustan hamara'?

- Ans
- 1. Rabindranath Tagore
  - 2. Ishwar Chandra Vidyasagar
  - 3. Mohammad Iqbal
  - 4. Mahatma Gandhi

Q.16 Which of the following is NOT a domestic cricket tournament organised by the Board of Control for Cricket in India (BCCI) in India?

- Ans
- 1. Vizzy Trophy
  - 2. Super Fours
  - 3. Ranji Trophy
  - 4. ZR Irani Cup

Q.17 Which of the following Articles of the Constitution of India deal with citizenship?

- Ans
- 1. Article 10 – 17
  - 2. Article 8 – 15
  - 3. Article 5 – 11
  - 4. Article 12 – 18

Q.18 Who discovered the atomic number based on X-ray wavelength in 1913?

- Ans
- 1. AEB de Chancourtis
  - 2. Dmitri Mendeleev
  - 3. Henry Moseley
  - 4. RA Millikan

Q.19 In which country is the 'Kachin Manaw Festival' celebrated?

- Ans
- 1. Sri Lanka
  - 2. Myanmar
  - 3. Nepal
  - 4. Maldives

Q.20 Which of the following is more important to promote modernisation and overall prosperity of a country?

- Ans
- 1. Stable export
  - 2. Stable employment
  - 3. Stable import
  - 4. Stable unemployment

Q.21 Which organisation launched the Indian Customs Compliance Information Portal (CIP) for providing free access to information on all Customs procedures and regulatory compliance for nearly 12,000 Customs Tariff items in the year 2021?

- Ans
- 1. Central Board for Indirect Taxes & Customs
  - 2. Income Tax Settlement Commission
  - 3. Central Board for Direct Taxes
  - 4. Directorate of Enforcement

Q.22 On 31 October 1940, who among the following was arrested for offering individual Satyagraha to protest against India's forced participation in Second World War?

- Ans
- 1. Saifuddin Kitchlew
  - 2. Subhas Chandra Bose
  - 3. Jawaharlal Nehru
  - 4. Sardar Vallabhbhai Patel

Q.23 Correctly match the following.

Type of Industries	Name of Company
1. Public sector	a. Tata Iron and Steel Company
2. Private sector	b. Bharat Heavy Electricals Limited
3. Joint sector	c. Oil India Ltd

- Ans
- 1. 1-b, 2-c, 3-a
  - 2. 1-a, 2-b, 3-c
  - 3. 1-c, 2-b, 3-a
  - 4. 1-b, 2-a, 3-c

Q.24 April 2023, the Maharashtra government has approved how much percentage of reservation for Divyang employees in promotions?

- Ans
- 1. 5%
  - 2. 2%
  - 3. 3%
  - 4. 4%

Q.25 Who among the following was the founder of 'Vikramshila Vishwavidyalaya'?

- Ans
- 1. Dharmapala
  - 2. Mahipala I
  - 3. Govindapala
  - 4. Ramapala

## Combined Higher Secondary Level Examination 2024 Tier I

Exam Date	02/07/2024
Exam Time	9:00 AM - 10:00 AM
Subject	CHSL Exam 2024 Tier I

### Section : English Language

1. The following sentence has been divided into four segments. Identify the segment that contains an error.

They have decided / to wind out / their business / without delay.

- Ans
- 1. They have decided
  - 2. their business
  - 3. to wind out
  - 4. without delay.

2. Select the option that corrects the following sentence.  
All the workers have called of the strike.

- Ans
- 1. All the workers have called at the strike.
  - 2. All the workers have called through the strike.
  - 3. All the workers have called between the strike.
  - 4. All the workers have called off the strike.

3. The given sentence is divided into four segments. Select the option that has the segment with a grammatical error. He organises / a children's fair every year / and his friends comes / to attend it.

- Ans
- 1. He organises
  - 2. a children's fair every year
  - 3. to attend it.
  - 4. and his friends comes

- Q.4 The underlined phrase in the given sentence has been used incorrectly. Select the option that can correctly replace the underlined segment.

Samita asked out a favour of going early today.

- Ans
- 1. asked for
  - 2. asked over
  - 3. asked around
  - 4. asked after

**Comprehension:**

In the following passage some words have been deleted. Read the passage carefully and select the most appropriate option to fill in each blank.

(1)\_\_\_\_\_health benefits, including protection from cardiovascular disease and cancer, have been (2)\_\_\_\_\_to antioxidants; however, according to dietitian Vinson, these benefits depend on how well antioxidants are absorbed and (3)\_\_\_\_\_by the body. According to the study, coffee has more antioxidant power than other well-known foods and drinks, like tea, milk, chocolate, and cranberries. Dates had the highest antioxidants per serving out of all the foods and drinks (4)\_\_\_\_\_, but because dates are not consumed to the same extent as coffee, the latter comes out on (5)\_\_\_\_\_, according to Vinson.

**SubQuestion No : 5**

**Q.5** Select the most appropriate option to fill in blank number 1.

- Ans**
- 1. Numerous
  - 2. Countable
  - 3. Limited
  - 4. Few

**Comprehension:**

In the following passage some words have been deleted. Read the passage carefully and select the most appropriate option to fill in each blank.

(1)\_\_\_\_\_health benefits, including protection from cardiovascular disease and cancer, have been (2)\_\_\_\_\_to antioxidants; however, according to dietitian Vinson, these benefits depend on how well antioxidants are absorbed and (3)\_\_\_\_\_by the body. According to the study, coffee has more antioxidant power than other well-known foods and drinks, like tea, milk, chocolate, and cranberries. Dates had the highest antioxidants per serving out of all the foods and drinks (4)\_\_\_\_\_, but because dates are not consumed to the same extent as coffee, the latter comes out on (5)\_\_\_\_\_, according to Vinson.

**SubQuestion No : 6**

**Q.6** Select the most appropriate option to fill in blank number 2.

- Ans**
- 1. attributed
  - 2. negative
  - 3. similar
  - 4. parallel

**Comprehension:**

In the following passage some words have been deleted. Read the passage carefully and select the most appropriate option to fill in each blank.

(1)\_\_\_\_\_health benefits, including protection from cardiovascular disease and cancer, have been (2)\_\_\_\_\_to antioxidants; however, according to dietitian Vinson, these benefits depend on how well antioxidants are absorbed and (3)\_\_\_\_\_by the body. According to the study, coffee has more antioxidant power than other well-known foods and drinks, like tea, milk, chocolate, and cranberries. Dates had the highest antioxidants per serving out of all the foods and drinks (4)\_\_\_\_\_, but because dates are not consumed to the same extent as coffee, the latter comes out on (5)\_\_\_\_\_, according to Vinson.

**SubQuestion No : 7**

**Q.7** Select the most appropriate option to fill in blank number 3.

- Ans**
- 1. utilised
  - 2. impede
  - 3. rejected
  - 4. hinder

**Comprehension:**

In the following passage some words have been deleted. Read the passage carefully and select the most appropriate option to fill in each blank.

(1)\_\_\_\_\_health benefits, including protection from cardiovascular disease and cancer, have been (2)\_\_\_\_\_to antioxidants; however, according to dietitian Vinson, these benefits depend on how well antioxidants are absorbed and (3)\_\_\_\_\_by the body. According to the study, coffee has more antioxidant power than other well-known foods and drinks, like tea, milk, chocolate, and cranberries. Dates had the highest antioxidants per serving out of all the foods and drinks (4)\_\_\_\_\_, but because dates are not consumed to the same extent as coffee, the latter comes out on (5)\_\_\_\_\_, according to Vinson.

**SubQuestion No : 8**

**Q.8** Select the most appropriate option to fill in blank number 4.

- Ans**
- 1. assimilated
  - 2. analysed
  - 3. synthesised
  - 4. consumed



**Comprehension:**

In the following passage some words have been deleted. Read the passage carefully and select the most appropriate option to fill in each blank.

(1)\_\_\_\_\_health benefits, including protection from cardiovascular disease and cancer, have been (2)\_\_\_\_\_to antioxidants; however, according to dietitian Vinson, these benefits depend on how well antioxidants are absorbed and (3)\_\_\_\_\_by the body. According to the study, coffee has more antioxidant power than other well-known foods and drinks, like tea, milk, chocolate, and cranberries. Dates had the highest antioxidants per serving out of all the foods and drinks (4)\_\_\_\_\_, but because dates are not consumed to the same extent as coffee, the latter comes out on (5)\_\_\_\_\_, according to Vinson.

**SubQuestion No : 9**

**Q.9** Select the most appropriate option to fill in blank number 5.

- Ans**
- 1. bottom
  - 2. lowest
  - 3. below
  - 4. top

**Q.10** Select the most appropriate synonym of the given word.  
**Competent**

- Ans**
- 1. Qualified
  - 2. Chatty
  - 3. Unskilled
  - 4. Dumb

**Q.11** Select the most appropriate ANTONYM of the underlined word.  
My parents have a fertile land in the backyard.

- Ans**
- 1. Barren
  - 2. Timid
  - 3. Scanty
  - 4. Potent

**Q.12** Select the most appropriate meaning of the given idiom.  
**Dog eat dog**

- Ans**
- 1. Ruthlessly competitive
  - 2. Tit for tat
  - 3. Being calculative
  - 4. Like-minded people connect better

**Q.13** Select the most appropriate connotation to fill in the blank.  
I always love the \_\_\_\_\_ of my mother's cooking.

- Ans**
- 1. aroma
  - 2. stench
  - 3. perfume
  - 4. scent

**Q.14** Select the most appropriate ANTONYM of the given word.  
**Enemy**

- Ans**
- 1. Combatant
  - 2. Colleague
  - 3. Friend
  - 4. Attacker

**Q.15** Select the correctly spelt word.

- Ans**
- 1. Illuseon
  - 2. Illusion
  - 3. Illuzion
  - 4. llusion

Q.16 Read the given sentence carefully. Change the meaning of the sentence by replacing the underlined word with its ANTONYM from the following options.

The equivocal tone of the Prime Minister in his speech caused uproar in the chamber.

- Ans
- 1. conflicting
  - 2. iffy
  - 3. explicit
  - 4. irresolute

Q.17 Select the most appropriate option that can substitute the underlined segment in the given sentence. If there is no need to substitute it, select 'No substitution required'.

The plum tree in our garden is cover in blossoms, as are the trees outside my office window.

- Ans
- 1. is covering at
  - 2. are cover at
  - 3. is covered in
  - 4. No substitution required

Q.18 Select the most appropriate option that can substitute the underlined segment in the given sentence. If there is no need to substitute it, select 'No substitution required'.

A soldier of the tenth legion leaped into the water as soon as the ship touches the shore.

- Ans
- 1. No substitution required
  - 2. the ship touched the shore
  - 3. the ship was touch the shore
  - 4. the ship touch the shore

Q.19 Select the most appropriate option that can substitute the underlined segment in the given sentence.  
We feel warm on the subject

- Ans
- 1. warmly about
  - 2. warming about
  - 3. warmer on
  - 4. warmed on

Q.20 Select the most appropriate meaning of the given idiom.  
Put in mind

- Ans
- 1. To calculate
  - 2. To remind
  - 3. To forget
  - 4. To understand

Q.21 Select the most appropriate option that can substitute the underlined segment in the given sentence.

The dictator ordered the traitor were jailed.

- Ans
- 1. is
  - 2. to be
  - 3. might
  - 4. was

Q.22 Select the INCORRECTLY spelt word.

- Ans
- 1. marijuena
  - 2. stationery
  - 3. dictator
  - 4. lascivious

Q.23 Select the most appropriate ANTONYM of the underlined word in the sentence.  
He laboured very hard but could not yield anything from the barren piece of land.

- Ans
- 1. Fertile
  - 2. Fruitless
  - 3. Vile
  - 4. Sterile

Q.24 Select the most appropriate ANTONYM of the underlined word in the given sentence.  
The dearth of governmental policies on the basic rights and comforts of the impaired population leads to low standard of public life in a country.

- Ans
- 1. Brevity
  - 2. Lacunae
  - 3. Abundance
  - 4. Paucity

Q.25 Select the most appropriate synonym of the given word.  
Wonderful

- Ans
- 1. Upright
  - 2. Synthetic
  - 3. Amazing
  - 4. Awful

Section : General Intelligence

Q.1 5 is related to 27 by certain logic. Following the same logic, 7 is related to 51. To which of the following is 4 related, following the same logic?  
(NOTE: Operations should be performed on the whole numbers, without breaking down the numbers into its constituent digits. E.g. 13 – Operations on 13 such as adding/subtracting/multiplying etc. to 13 can be performed. Breaking down 13 into 1 and 3 and then performing mathematical operations on 1 and 3 is not allowed.)

- Ans
- 1. 15
  - 2. 64
  - 3. 18
  - 4. 37

Q.2 A paper is folded and cut as shown below. How will it appear when unfolded?

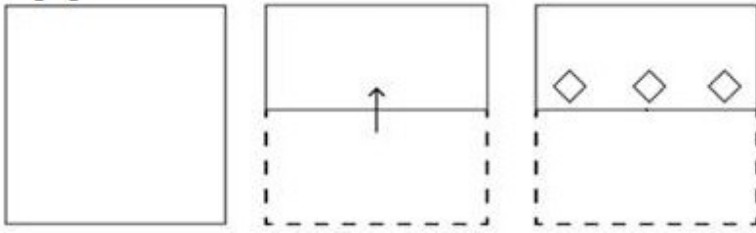

Ans

1.

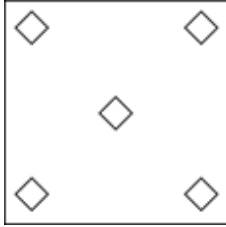

2.

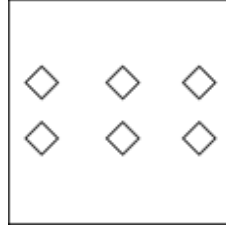

3.

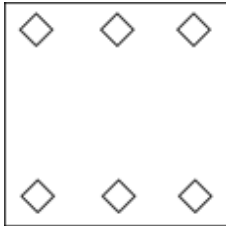

4.

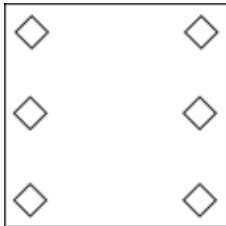

Q.3 Which of the following numbers will replace the question mark (?) in the given series?

6, 16, 36, 76, ?, 316

Ans

1. 152

2. 146

3. 156

4. 168

Q.4 Select the correct mirror image of the given figure when the mirror is placed at AB as shown below.

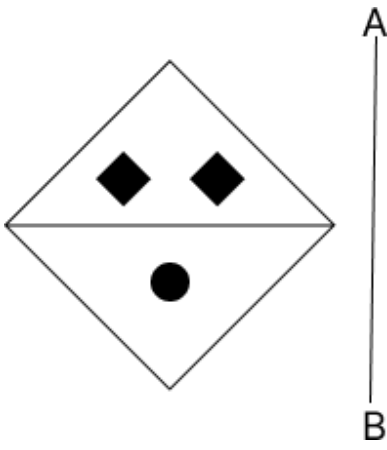

Ans

X 1.

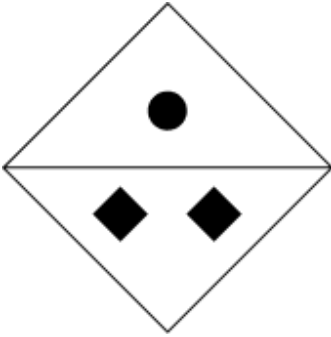

X 2.

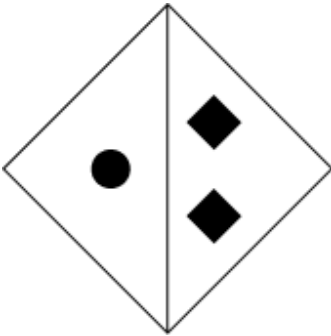

X 3.

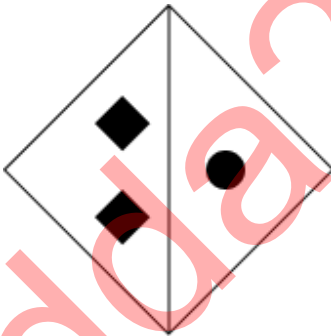

✓ 4.

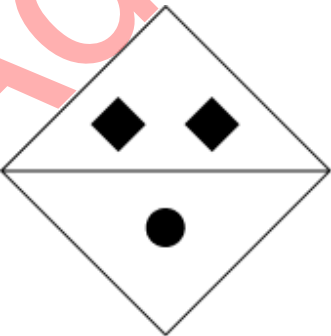

Q.5 Select the option figure in which the given figure (X) is embedded as its part (rotation is NOT allowed).

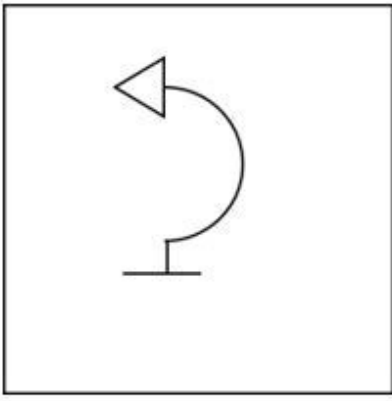

(X)

Ans

✓ 1.

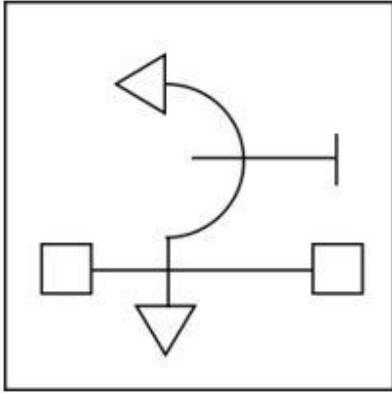

✗ 2.

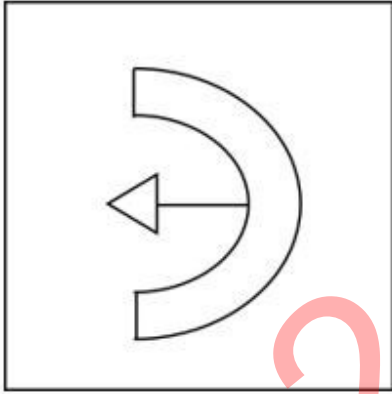

✗ 3.

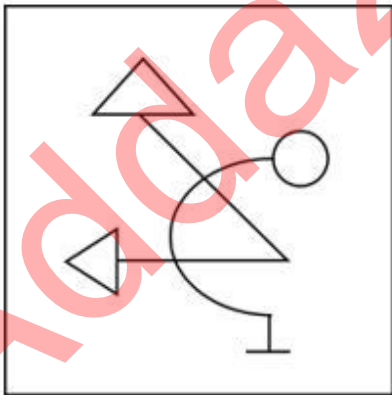

✗ 4.

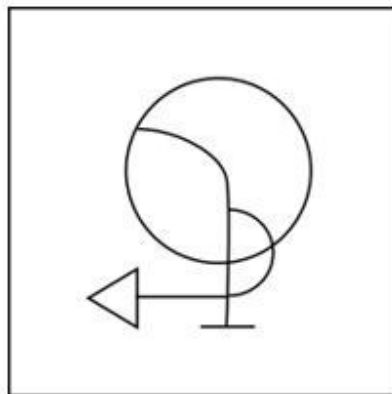

Adda247 Marathi

Q.6 Three statements are followed by conclusions numbered I, II. You have to consider these statements to be true, even if they seem to be at variance with commonly known facts. Decide which of the given conclusions logically follow/s from the given statement.

Statements:

All journals are books.

Some books are fans.

All fans are wood.

Conclusion (I): Some journals are wood.

Conclusion (II): Some fans are books.

- Ans
- 1. Neither conclusion (I) nor (II) follows.
  - 2. Both conclusions (I) and (II) follow.
  - 3. Only conclusion (II) follows.
  - 4. Only conclusion (I) follows.

Q.7 The position of how many letters will remain unchanged if each of the letters in the word 'ABDUCTS' is arranged in English alphabetical order?

- Ans
- 1. More than four
  - 2. Three
  - 3. Four
  - 4. Two

Q.8 What should come in place of the question mark (?) in the given series?

131, 263, 527, 1055, ?

- Ans
- 1. 1121
  - 2. 2121
  - 3. 1211
  - 4. 2111

Q.9 What will come in the place of the question mark (?) in the following equation, if '+' and '×' are interchanged and '-' and '÷' are interchanged?

$$132 - 12 \times 17 + 3 \div 27 = ?$$

- Ans
- 1. 30
  - 2. 36
  - 3. 32
  - 4. 35

Q.10 What will come in the place of the question mark (?) in the following equation, if '+' and '-' are interchanged and '×' and '÷' are interchanged?

$$80 + 18 \times 3 \div 5 - 23 = ?$$

- Ans
- 1. 73
  - 2. 85
  - 3. 88
  - 4. 80

Q.11 Select the set in which the numbers are related in the same way as are the numbers of the following sets.  
(NOTE: Operations should be performed on the whole numbers, without breaking down the numbers into their constituent digits. E.g. 13 – Operations on 13 such as adding/subtracting/multiplying etc. to 13 can be performed. Breaking down 13 into 1 and 3 and then performing mathematical operations on 1 and 3 is not allowed.)  
(6, 12, 3)  
(10, 20, 5)

- Ans
- 1. (21, 28, 7)
  - 2. (14, 28, 7)
  - 3. (14, 21, 7)
  - 4. (14, 28, 9)

Q.12 What would be the letter on the opposite side of 'R' if the given sheet is folded to form a cube?

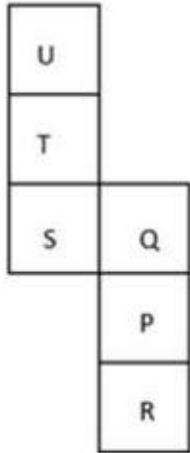

- Ans
- 1. T
  - 2. S
  - 3. U
  - 4. Q



Q.13 Identify the figure given in the options that when put in place of the question mark (?) will logically complete the series.

P	4	↑	P	V	↑	P	V	
	↑		4		P		↑	?
△	V	3	3	△	V	4	L	3

Ans

✗ 1.

L		P
	V	
↑	3	4

✗ 2.

V		L
	4	
P	↑	3

✓ 3.

L		P
	V	
↑	=	3

✗ 4.

3		P
	4	
L	=	V

Q.14 'A × B' means 'A is B's brother'.  
 'A ÷ B' means 'A is B's sister'.  
 'A + B' means 'A is B's father'.  
 'A - B' means 'A is B's mother'.  
 Using the same meaning of the mathematical operators as given above, which of the following means 'X is Z's mother's father'?

- Ans
- ✓ 1.  $X + Y - Z$
  - ✗ 2.  $X - Y + Z$
  - ✗ 3.  $X + Y \times Z$
  - ✗ 4.  $X \times Y + Z$

Q.15 Four letter-clusters have been given, out of which three are alike in some manner and one is different. Select the one that is different.  
 (Note: The odd one out is not based on the number of consonants/vowels or their position in the letter cluster.)

- Ans
- ✓ 1. PTV
  - ✗ 2. E J H
  - ✗ 3. X C A
  - ✗ 4. L Q O

Q.16 What is the maximum number of rectangles in the given figure?

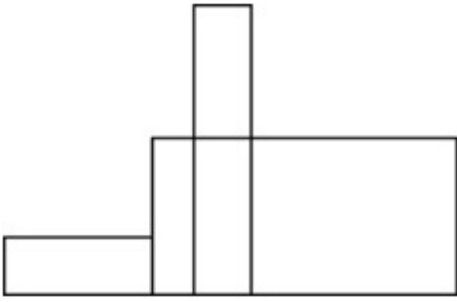

- Ans
- 1. 12
  - 2. 8
  - 3. 10
  - 4. 9

Q.17 What should come in place of the question mark (?) to complete the following letter-cluster series?  
BDC, EGF, HJI, ?

- Ans
- 1. KLN
  - 2. LMN
  - 3. KML
  - 4. KLM

Adda247 Marathi

Q.18 Select the option in which the given figure is embedded (rotation is NOT allowed).

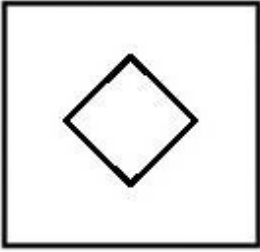

Ans

✗ 1.



✓ 2.

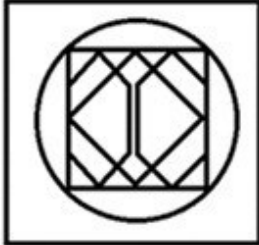

✗ 3.



✗ 4.

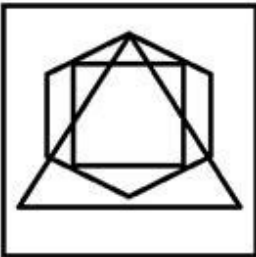

Q.19 What should come in place of the question mark (?) in the given series?

8, 21, 34, 47, 60, ?

Ans ✗ 1. 71

✗ 2. 72

✓ 3. 73

✗ 4. 70

Q.20 In a certain code language, 'art of war' is coded as 'gb pr ml' and 'the lost art' is coded as 'ml sj ak'. How is 'art' coded in the given language?

Ans ✗ 1. gb

✓ 2. ml

✗ 3. pr

✗ 4. ak

Q.21 If 9 March 2007 was Friday, then what was the day of the week on 13 March 2012?

- Ans
- 1. Tuesday
  - 2. Thursday
  - 3. Monday
  - 4. Wednesday

Q.22 In a certain code language, 'MONEY' is coded as '64381' and 'HONEY' is coded as '54381'. What is the code for 'H' in that language?

- Ans
- 1. 5
  - 2. 6
  - 3. 4
  - 4. 8

Q.23 Select the pair which follows the same pattern as that followed by the two set of pairs given below. Both pairs follow the same pattern.

PTL : NRJ

AEX : YCV

- Ans
- 1. GIF : FIG
  - 2. BTM : DVO
  - 3. TVN : RTL
  - 4. ABC : ZTS

Q.24 Which two numbers should be interchanged to make the given equation correct?

$$45 \div 3 + 12 \times 9 - 15 + 2 \times 5 = 36$$

(NOTE: Numbers must be interchanged and not the constituent digits e.g. if 2 and 3 are to be interchanged in the equation  $43 \times 3 + 4 \div 2$ , then interchanged equation is  $43 \times 2 + 4 \div 3$ )

- Ans
- 1. 3 and 9
  - 2. 2 and 9
  - 3. 5 and 3
  - 4. 12 and 5

Q.25 Select the word-pair that best represents a similar relationship to the one expressed in the pair of words given below. (The words must be considered as meaningful English words and must not be related to each other based on the number of letters/number of consonants/vowels in the word.)

Plain : Austere

- Ans
- 1. Clean : Sterile
  - 2. Lonely : Gloomy
  - 3. Neutral : Detached
  - 4. Abandon : Barren

Section : Quantitative Aptitude

Q.1 The ratio of a father's age to his son's age is 7 : 4. The product of the numbers representing their ages is 1372. The ratio of their ages after 8 years will be:

- Ans
- 1. 19 : 11
  - 2. 19 : 12
  - 3. 19 : 13
  - 4. 19 : 14

Q.2

The following table shows the production of cars in a company from 2016 to 2020.

Years	2016	2017	2018	2019	2020
A	30	23	39	25	18
B	16	10	14	12	8
C	15	18	19	25	30
D	31	12	21	19	20

There was a continuous decrease in the production of cars of which types during the period 2018 to 2020?

- Ans
- 1. A,B
  - 2. C,D
  - 3. B,C
  - 4. B,D

Q.3 In  $\triangle ABC$ , XY is drawn parallel to BC, cutting sides at X and Y, where AB = 5.4 cm, BC = 7.2 cm and BX = 3 cm. What is the length of XY (in cm)?

- Ans
- 1. 4.3
  - 2. 3.0
  - 3. 3.2
  - 4. 2.8

Q.4 Simplify:  $18 \div (7 \times 2 - 5) \times 5 \times 24 \div 30$

- Ans
- 1. 8
  - 2. 0.5
  - 3. 10
  - 4. 6

Q.5 If the diameter of a hemisphere is 21 cm, then the curved surface area (in  $cm^2$ ) of the hemisphere is:

Take  $\pi = \frac{22}{7}$

- Ans
- 1. 693
  - 2. 963
  - 3. 939
  - 4. 639

Q.6

Study the given graph and select the most appropriate option to fill in the blanks. Consider the percentage of workers in three categories, Skilled, Semi-skilled and Un-skilled in four companies, A, B, C and D in the graph below.

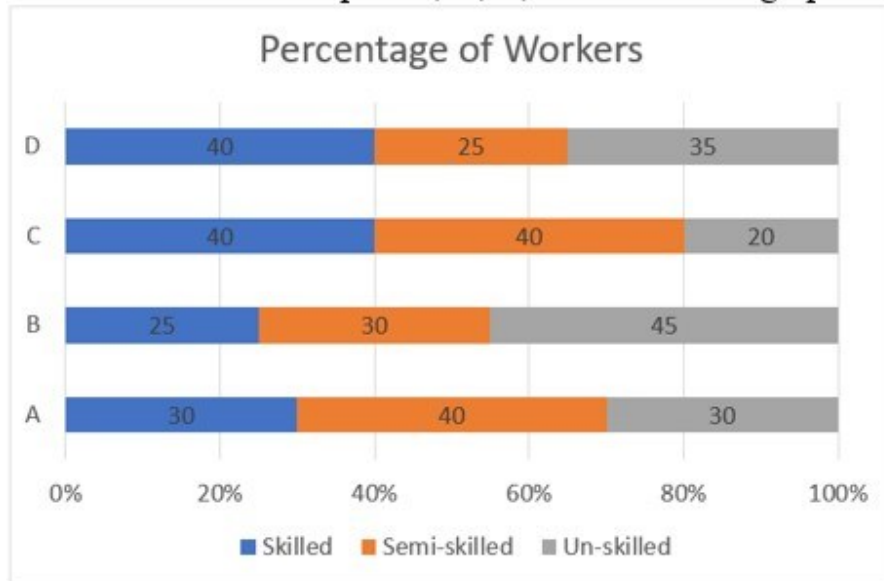

If all the companies have same number of total workers, then the company \_\_\_\_\_ has the highest number of Un-skilled workers and the company \_\_\_\_\_ has the lowest number of Skilled workers.

Ans



1. B; C



2. B; B



3. C; C



4. C; B

Q.7 A boat can travel 60km downstream in 4 hours. If the speed of the boat in still water is 13 km/h, then in what time will it cover 30 km upstream?

Ans

1.  $2\frac{8}{11}$  hours2.  $3\frac{4}{7}$  hours3.  $2\frac{4}{7}$  hours4.  $3\frac{5}{7}$  hours

Q.8 A dozen pairs of gloves of ₹ 180 are available at a discount of 10%. How many pairs of gloves can be bought for ₹ 54?

Ans



1. 2



2. 8



3. 4



4. 6

Q.9 During the first year the population of a village increased by 5% and during the second year it diminished by 5%. At the end of the second year its population was 47,880. What was the population at the beginning of the first year?

Ans



1. 45000



2. 48000



3. 43500



4. 53000

Q.10 How many numbers lie between 2000 and 2020 that are divisible by 8?

Ans  1. 2

2. 5

3. 3

4. 4

Q.11 Mahesh's annual salary increased from ₹2,00,000 to ₹2,40,000. Find the percentage increase in the salary.

Ans  1. 22%

2. 18%

3. 24%

4. 20%

Q.12 Twelve men working for 9 hours a day complete a piece of work in 24 days. In how many days can 8 men working for 12 hours a day complete the same piece of work?

Ans  1. 27 days

2. 28 days

3. 21 days

4. 24 days

Q.13 The perimeter of a minor sector of a circle of radius 4 units subtending an angle of  $45^\circ$  is:

Ans  1.  $4 - \pi$  units

2.  $8 - \pi$  units

3.  $8 + \pi$  units

4.  $4 + \pi$  units

Q.14 The areas of two similar triangles  $\Delta PQR$  and  $\Delta XYZ$  are  $12.96 \text{ cm}^2$  and  $635.04 \text{ cm}^2$ , respectively. If  $QR = 2.9 \text{ cm}$ , then the length (in cm) of  $YZ$  equals:

Ans  1. 30.4

2. 20.3

3. 23.2

4. 25.2

Q.15

Study the following line graph carefully and answer the question below.

Given graph represents marks obtained by Riya and Rida in six subjects of 12<sup>th</sup> exam of CBSE. Maximum marks in Maths, Physics and Chemistry is 140 whereas maximum marks in English, IP and Biology is 180.

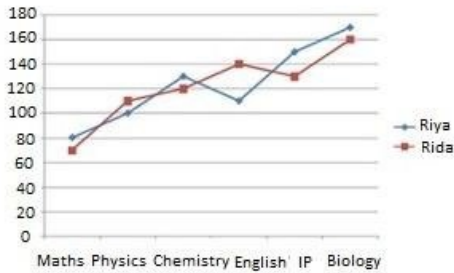

What is percentage marks obtained by Rida in PCM (Maths, Physics and Chemistry)?

Ans

1. 81.32%

2. 50%

3. 71.43%

4. 78.57%

Q.16

Study the given bar-graph carefully and answer the question that follows.

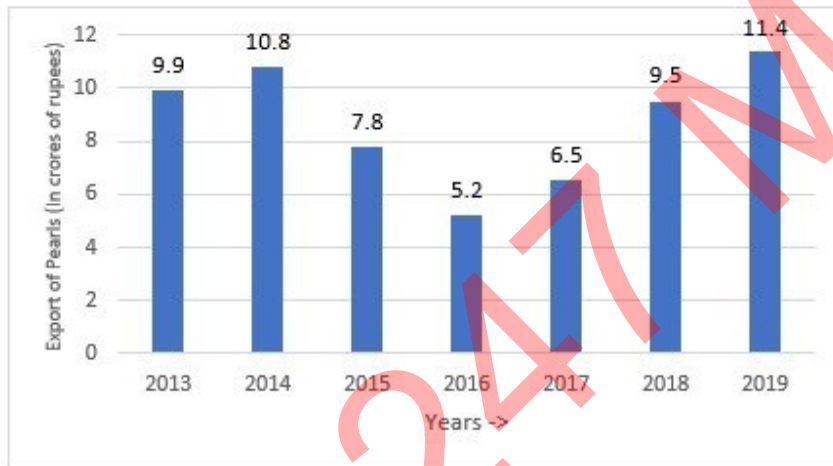

In which year was there maximum percentage increase in the export of pearls to that in the previous year?

Ans

1. 2018

2. 2014

3. 2017

4. 2019

Q.17

In a group of 250 persons, 40% are males and 60% are females. If 30 more females join the group, then what will be the percentage of females in the new group? (Correct to 2 decimal places)

Ans

1. 62.58%

2. 72.25%

3. 64.29%

4. 90.25%



Q.18

What is the value of  $\cos(x + y) - \sin(x - y) + \tan(2z)$ ?

Ans

- 1.  $\cos x \cdot \cos y - \sin x \cdot \sin y - \sin x \cdot \cos y - \cos x \cdot \sin y + \frac{2 \tan z}{1 - \tan^2 z}$
- 2.  $\cos x \cdot \cos y - \sin x \cdot \sin y - \sin x \cdot \cos y + \cos x \cdot \sin y + \frac{2 \tan z}{1 - \tan^2 z}$
- 3.  $\cos x \cdot \cos y - \sin x \cdot \sin y - \cos x \cdot \sin y + \frac{\tan z}{1 - \tan^2 z}$
- 4.  $\sin x \cdot \sin y + \frac{2 \tan z}{1 - \tan^2 z}$

Q.19

A merchant sold two refrigerators for ₹10,000 each. On one refrigerator, he incurred a 20% loss, and on the other, he gained 20%. What was his profit/loss percentage on the whole transaction?

Ans

- 1. Profit of 4%
- 2. Loss of 2%
- 3. Loss of 4%
- 4. Profit of 2%

Q.20

O is the centre and the arc PQR subtends an angle of  $240^\circ$  at O. PQ is extended to A. Then  $\angle AQR$  is:

Ans

- 1.  $180^\circ$
- 2.  $60^\circ$
- 3.  $240^\circ$
- 4.  $120^\circ$

Q.21

A bank charges simple interest for ₹K at the rate of  $r^{\frac{1}{2}}$  for  $n^2$  years. Another bank charges simple interest for ₹L at the rate of  $r^{\frac{3}{2}}$  for  $n^3$  years and gives the same interest. The ratio between K and L is:

Ans

- 1.  $\frac{1}{r} : \frac{1}{n}$
- 2.  $r n : 1$
- 3.  $r^2 : n^2$
- 4.  $r^{\frac{1}{2}} : n^{\frac{1}{2}}$

Q.22 The graphs of two linear equations,  $x + 2y = 15$  and  $4x + 8y = 13$  will be:

Ans

- 1. parallel
- 2. coincident
- 3. intersecting at one point
- 4. intersecting at two points

Q.23

The capacity of a cylinder tank is  $8316 \text{ cm}^3$ . If the radius of its base is 21 cm, then find the depth of the tank.

Ans

- 1. 4 cm
- 2. 8 cm
- 3. 10 cm
- 4. 6 cm

Q.24 How much water should be added to 60 liters of milk at  $1\frac{1}{2}$  liters a rupee so as to have a mixture worth  $1\frac{7}{8}$  liters a rupee?

- Ans
- 1. 15 liters
  - 2. 12 liters
  - 3. 27 liters
  - 4. 20 liters

Q.25

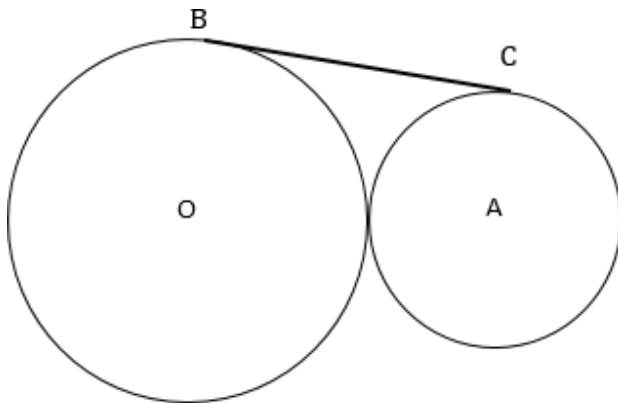

[Figure is not drawn to scale.]

Two circles touch each other externally as shown in the figure above. The radius of the circle with centre O is 49 cm. The radius of the circle with centre A is 16 cm. Find the length (in cm) of their common tangent BC.

- Ans
- 1. 56
  - 2. 55
  - 3. 58
  - 4. 57

Section : General Awareness

1. On which river in India was the Somasila Dam built?

- Ans
- 1. Krishna river
  - 2. Pennar river
  - 3. Sabarmati river
  - 4. Tapti river

2. Which theory describes the collective effects of changes in Earth's movements on its climate over thousands of years?

- Ans
- 1. Plate tectonics theory
  - 2. Copernicus' heliocentric theory
  - 3. Milankovitch theory
  - 4. Continental drift theory

3. How many times has India won the South Asian Football Federation (SAFF) Championship as of December 2023?

- Ans
- 1. 5 times
  - 2. 7 times
  - 3. 6 times
  - 4. 9 times

Q.4 Which of the following types of crops are sown after the end of the monsoon season?

- Ans
- 1. Zaid crops
  - 2. Kharif crops
  - 3. Rabi crops
  - 4. Vital crops

Q.5 By which ministry of Government of India was the Deendayal Antyodaya Yojana started?

- Ans
- 1. Ministry of Rural Development
  - 2. Ministry of Home affairs
  - 3. Ministry of Labour and Employment
  - 4. Ministry of Corporate affairs

Q.6 How many types of writs can be issued by the Supreme Court to protect the Fundamental Rights of Indian citizens?

- Ans
- 1. Six
  - 2. Four
  - 3. Five
  - 4. Seven

Q.7 What is the name of the centrally sponsored scheme related with literacy that was launched by the Government of India in March 2023?

- Ans
- 1. National Literacy Programme
  - 2. New India Literacy Programme
  - 3. India Literacy Programme
  - 4. Bharat Padhega

Q.8 Match the following musical instruments with the maestros who play them.

- |            |                           |
|------------|---------------------------|
| a. Santoor | i. Bismillah Khan         |
| b. Sitar   | ii. Ustad Binda Khan      |
| c. Shehnai | iii. Pt Shiv Kumar Sharma |
| d. Sarangi | iv. Anushka Shankar       |

- Ans
- 1. a-iv, b-iii, c-ii, d-i
  - 2. a-i, b-ii, c-iii, d-iv
  - 3. a-ii, b-iii, c-i, d-iv
  - 4. a-iii, b-iv, c-i, d-ii

Q.9 In 2023, Gulab Chand Kataria became the Governor of which of the following states?

- Ans
- 1. Himachal Pradesh
  - 2. Tamil Nadu
  - 3. Odisha
  - 4. Assam

Q.10 Match List-I (Name of the composition) with List-II (Writer).

List-I (Name of the Composition)		List-II (Writer)	
1.	Vande Mataram	A.	Pradeep
2.	Jana Gana Mana	B.	Bankim Chandra Chattopadhyay
3.	Ae Mere Watan Ke Logon	C.	Rabindranath Tagore

- Ans
- 1. 1-C, 2-B, 3-A
  - 2. 1-C, 2-A, 3-B
  - 3. 1-A, 2-B, 3-C
  - 4. 1-B, 2-C, 3-A

Q.11 As per Olympic rules, in the third game, badminton players change ends when a side scores \_\_\_\_\_ points.

- Ans
- 1. 11
  - 2. 13
  - 3. 15
  - 4. 12

Q.12 The loss of water in the form of water droplets from leaves of plants is called \_\_\_\_\_.

- Ans
- 1. Pressure gradient
  - 2. Guttation
  - 3. Translocation
  - 4. Plasmolysis

Q.13 A \_\_\_\_\_ is a cloud of dust and gas inside a galaxy.

- Ans
- 1. photosphere
  - 2. black hole
  - 3. chromosphere
  - 4. nebula

Q.14 Who among the following was appointed, to the UN tax committee in July 2021, as a member for the 2021 to 2025 term?

- Ans
- 1. Vivek Singh
  - 2. Vipul Bansal
  - 3. Rasmi Ranjan Das
  - 4. TV Somanathan

Q.15 Who is the founder of modern micro finance ?

- Ans
- 1. VKV Rao
  - 2. Rangarajan
  - 3. YV Reddy
  - 4. Muhammad Yunus

Q.16 PC Mahalanobis is remembered as a major contributor of India's developmental path because he \_\_\_\_\_.  
(A) set up Indian Institutes of Management located in different parts of India  
(B) formulated the Second Five-Year Plan  
(C) was the first Minister of Statistics and Programme Implementation

- Ans
- 1. Only (A) and (C) are true
  - 2. Only (A) and (B) are true
  - 3. Only (A) is true
  - 4. Only (B) is true

Q.17 Who among the following was primarily an integral part of the Indian National Army (INA)?

- Ans
- 1. Rabindranath Tagore
  - 2. Chittaranjan Das
  - 3. Abanindranath Tagore
  - 4. Subhas Chandra Bose

Q.18 Which Clause of Article 20 incorporates the doctrine of double jeopardy?

- Ans
- 1. 1
  - 2. 4
  - 3. 3
  - 4. 2

Q.19 According to the Census of India-2011, which state has the largest gap between male and female literacy rates?

- Ans
- 1. Assam
  - 2. Rajasthan
  - 3. Karnataka
  - 4. Andhra Pradesh

Q.20 Which of the following was the last dynasty of the Vijayanagara Empire?

- Ans
- 1. Aravidu dynasty
  - 2. Sangam dynasty
  - 3. Saluva dynasty
  - 4. Tuluva dynasty

Q.21 In MS Word, which feature allows you to create different headers and footers for odd and even pages in a document?

- Ans
- 1. Different First Page
  - 2. Page Breaks
  - 3. Different Odd & Even Pages
  - 4. Section Breaks

Q.22 \_\_\_\_\_ is a significant festival of the Parsi people who practice Zoroastrianism as it marks the birth anniversary of Zoroaster.

- Ans
- 1. Jamshed-e-Navroz
  - 2. Pateti
  - 3. Khordad Sal
  - 4. Gahambars

Q.23 Who among the following is a famous classical dancer?

- Ans
- 1. Sonal Mansingh
  - 2. Asha Bhosle
  - 3. Pratibha Ray
  - 4. S Janaki

Q.24 In which year was tennis included in the Olympic games?

- Ans
- 1. 1948
  - 2. 1935
  - 3. 1896
  - 4. 1927

Q.25 Which kind of computer security requires verifying the genuineness of the individuals or organisations that want to access a system?

- Ans
- 1. Non-repudiation
  - 2. Availability
  - 3. Authentication
  - 4. Confidentiality

Adda247 Marathi

## Combined Higher Secondary Level Examination 2024 Tier I

Exam Date	02/07/2024
Exam Time	11:45 AM - 12:45 PM
Subject	CHSL Exam 2024 Tier I

### Section : English Language

1. The following sentence has been split into segments. Identify the segment that contains a grammatical error. If you don't find any error, mark 'No error' as your answer.  
I goes to / attend dance classes at / the National Dance Academy.

- Ans
- 1. No error
  - 2. attend dance classes at
  - 3. the National Dance Academy.
  - 4. I goes to

2. Select the option that corrects the following sentence.  
He has broken his leg yesterday.

- Ans
- 1. He broke his leg yesterday.
  - 2. He had broke his leg yesterday.
  - 3. He have broken his leg yesterday.
  - 4. He has broke his leg yesterday.

3. The following sentence has been split into four segments. Identify the segment that contains a grammatical error. I noticed that they / did not went to / the museum but entered / a shopping complex.

- Ans
- 1. the museum but entered
  - 2. did not went to
  - 3. a shopping complex.
  - 4. I noticed that they

- Q.4 The given sentence is divided into three segments. Select the option that has the segment with a grammatical error. If there is no error, select 'No error'.  
The meeting was called off / due to a medical emergency of / the manager of the company.

- Ans
- 1. No error
  - 2. the manager of the company.
  - 3. The meeting was called off
  - 4. due to a medical emergency of

**Comprehension:**

In the following passage, some words have been deleted. Read the passage carefully and select the most appropriate option to fill in each blank.

If we look at the global population, out of every six persons living in this world, one is an Indian and (1)\_\_\_\_\_ a Chinese. The population of Pakistan is very (2)\_\_\_\_\_ and accounts for roughly about one-tenth of China or India. Though China is the largest nation and geographically (3)\_\_\_\_\_ the largest area among the three nations, its density is the lowest. Scholars point out the one child (4)\_\_\_\_\_ in China in the late 1970s as the major reason for low population growth. They also state that this measure led to a (5)\_\_\_\_\_ in the sex ratio, the proportion of females per 1000 males.

**SubQuestion No : 5**

**Q.5 Select the most appropriate option to fill in blank number 1.**

- Ans**
- 1. many
  - 2. another
  - 3. either
  - 4. second

**Comprehension:**

In the following passage, some words have been deleted. Read the passage carefully and select the most appropriate option to fill in each blank.

If we look at the global population, out of every six persons living in this world, one is an Indian and (1)\_\_\_\_\_ a Chinese. The population of Pakistan is very (2)\_\_\_\_\_ and accounts for roughly about one-tenth of China or India. Though China is the largest nation and geographically (3)\_\_\_\_\_ the largest area among the three nations, its density is the lowest. Scholars point out the one child (4)\_\_\_\_\_ in China in the late 1970s as the major reason for low population growth. They also state that this measure led to a (5)\_\_\_\_\_ in the sex ratio, the proportion of females per 1000 males.

**SubQuestion No : 6**

**Q.6 Select the most appropriate option to fill in blank number 2.**

- Ans**
- 1. small
  - 2. obscure
  - 3. much
  - 4. a little

**Comprehension:**

In the following passage, some words have been deleted. Read the passage carefully and select the most appropriate option to fill in each blank.

If we look at the global population, out of every six persons living in this world, one is an Indian and (1)\_\_\_\_\_ a Chinese. The population of Pakistan is very (2)\_\_\_\_\_ and accounts for roughly about one-tenth of China or India. Though China is the largest nation and geographically (3)\_\_\_\_\_ the largest area among the three nations, its density is the lowest. Scholars point out the one child (4)\_\_\_\_\_ in China in the late 1970s as the major reason for low population growth. They also state that this measure led to a (5)\_\_\_\_\_ in the sex ratio, the proportion of females per 1000 males.

**SubQuestion No : 7**

**Q.7 Select the most appropriate option to fill in blank number 3.**

- Ans**
- 1. grasps
  - 2. occupies
  - 3. rents
  - 4. lodges



**Comprehension:**

In the following passage, some words have been deleted. Read the passage carefully and select the most appropriate option to fill in each blank.

If we look at the global population, out of every six persons living in this world, one is an Indian and (1)\_\_\_\_\_ a Chinese. The population of Pakistan is very (2)\_\_\_\_\_ and accounts for roughly about one-tenth of China or India. Though China is the largest nation and geographically (3)\_\_\_\_\_ the largest area among the three nations, its density is the lowest. Scholars point out the one child (4)\_\_\_\_\_ in China in the late 1970s as the major reason for low population growth. They also state that this measure led to a (5)\_\_\_\_\_ in the sex ratio, the proportion of females per 1000 males.

**SubQuestion No : 8**

**Q.8** Select the most appropriate option to fill in blank number 4.

- Ans**
- 1. average
  - 2. statute
  - 3. ordeal
  - 4. standard

**Comprehension:**

In the following passage, some words have been deleted. Read the passage carefully and select the most appropriate option to fill in each blank.

If we look at the global population, out of every six persons living in this world, one is an Indian and (1)\_\_\_\_\_ a Chinese. The population of Pakistan is very (2)\_\_\_\_\_ and accounts for roughly about one-tenth of China or India. Though China is the largest nation and geographically (3)\_\_\_\_\_ the largest area among the three nations, its density is the lowest. Scholars point out the one child (4)\_\_\_\_\_ in China in the late 1970s as the major reason for low population growth. They also state that this measure led to a (5)\_\_\_\_\_ in the sex ratio, the proportion of females per 1000 males.

**SubQuestion No : 9**

**Q.9** Select the most appropriate option to fill in blank number 5.

- Ans**
- 1. decline
  - 2. suspension
  - 3. diminish
  - 4. failure

**Q.10** Select the most appropriate ANTONYM of the given word.

**Lethargic**

- Ans**
- 1. Exhausted
  - 2. Intelligent
  - 3. Active
  - 4. Cute

**Q.11** Select the most appropriate option that can substitute the underlined segment in the given sentence.

Please take many as you want.

- Ans**
- 1. so much
  - 2. as much
  - 3. too much
  - 4. much of

**Q.12** Select the most appropriate synonym of the bracketed word in the following sentence to fill in the blank.  
The city's infrastructure was ill-equipped to handle the influx of \_\_\_\_\_ (visitors) during the peak season.

- Ans**
- 1. tourists
  - 2. citizens
  - 3. natives
  - 4. residents

Q.13 Select the most appropriate option to fill in the blank.  
Both the criminals were cruel and \_\_\_\_\_.

- Ans
- 1. sympathetic
  - 2. warm
  - 3. brutal
  - 4. diligent

Q.14 Select the most appropriate option that can substitute the underlined segment in the following sentence.  
Rimjhim received a children's very illustrated colourful atlas on her 10th birthday.

- Ans
- 1. a very illustrated colourful atlas children
  - 2. a very colourful illustrated children's atlas
  - 3. an very illustrated colourful children's atlas
  - 4. a colourful very illustrated children's atlas

Q.15 Identify the incorrectly spelt word and select its correct spelling.  
Wether we want to admit it or not, we all wish everyone would like us.

- Ans
- 1. addmit
  - 2. whether
  - 3. admitt
  - 4. whither

Q.16 Select the most appropriate meaning of the given idiom.  
Slip your mind

- Ans
- 1. Forget about something
  - 2. Think about something for a short time
  - 3. Immediately think of something
  - 4. Can't think of anything to say

Q.17 Select the most appropriate option to fill in the blank.

I was in the \_\_\_\_\_ of a meeting when somebody called me.

- Ans
- 1. centre
  - 2. corner
  - 3. round
  - 4. middle

Q.18 Select the most appropriate spelling of the underlined word in the given sentence.  
The prison is euphemistically called a 'rehabillitation centre'.

- Ans
- 1. rehabiliation
  - 2. rehabilitation
  - 3. rehbilitation
  - 4. rehabilation

Q.19 Identify the most appropriate synonym of the following word.  
Implicate

- Ans
- 1. Complain
  - 2. Confuse
  - 3. Accuse
  - 4. Interrogate

Q.20 Select the most appropriate ANTONYM of the word given in brackets to fill in the blank.  
The firefighter summoned all her \_\_\_\_\_(cowardice) and rushed into the burning building.

- Ans
- 1. skills
  - 2. erudition
  - 3. courage
  - 4. expertise

Q.21 Select the most appropriate homonym to fill in the blank.

\_\_\_\_\_ is a red-coloured root vegetable.

- Ans
- 1. Beet
  - 2. Beat
  - 3. Bead
  - 4. Bit

Q.22 Select the most appropriate synonym of the given word.  
Pliable

- Ans
- 1. Severe
  - 2. Probable
  - 3. Malleable
  - 4. Rigid

Q.23 Select the most appropriate meaning of the given idiom.  
Lose heart

- Ans
- 1. To be suspicious of your success
  - 2. To get success by believing in yourself
  - 3. To stop believing that you can succeed
  - 4. To believe in your success

Q.24 Select the most appropriate option that can substitute the underlined words in the following sentence.  
I hope you have enjoying yourselves at the party tonight!

- Ans
- 1. enjoys yourselves
  - 2. will be enjoy himself
  - 3. are enjoying themselves
  - 4. enjoy yourselves

Q.25 Select the most appropriate option that can substitute the underlined segment in the given sentence.

Their was a large snake found in the garden last evening.

- Ans
- 1. There was a large snake
  - 2. There was the larger snake
  - 3. There was not a large snake
  - 4. Their was the larger snake

Section : General Intelligence

1. In a certain code language,  
'M & N' means 'M is the wife of N',  
'M @ N' means 'M is the brother of N',  
'M \$ N' means 'M is the father of N',  
'M # N' means 'M is the sister of N'.  
Based on this, how is D related to H, if 'D & E \$ F # G @ H'?

- Ans
- 1. Father's sister
  - 2. Sister
  - 3. Father's mother
  - 4. Mother

Q.2 Select the set in which the numbers are related in the same way as are the numbers of the following sets.

(5, 7, 74)

(6, 4, 52)

(NOTE : Operations should be performed on the whole numbers, without breaking down the numbers into its constituent digits. E.g. 13 – Operations on 13 such as adding /subtracting /multiplying etc., to 13 can be performed. Breaking down 13 into 1 and 3 and then performing mathematical operations on 1 and 3 is not allowed.)

Ans  1. (11, 5, 146)

2. (6, 2, 52)

3. (9, 5, 206)

4. (9, 5, 405)

Q.3 If 'A' stands for '+', 'B' stands for '×', 'C' stands for '+' and 'D' stands for '−', what will come in place of the question mark (?) in the following equation?

44 B 5 C 68 D 144 A 4 = ?

Ans  1. 252

2. 250

3. 254

4. 256

Q.4 What should come in place of the question mark (?) in the given series?

3977, 3877, 3777, 3677, 3577, ?

Ans  1. 3333

2. 3477

3. 3277

4. 3377

Q.5 Three statements are followed by conclusions numbered I, II. You have to consider these statements to be true, even if they seem to be at variance with commonly known facts. Decide which of the given conclusions logically follow/s from the given statement.

Statements:

All shirts are pants.

Some dresses are pants.

Some pants are ties.

Conclusion (I): Some dresses are ties.

Conclusion (II): Some ties are shirts.

Ans  1. Only conclusion (I) follows.

2. Both conclusions (I) and (II) follow.

3. Only conclusion (II) follows.

4. Neither conclusion (I) nor (II) follows.

Q.6 How many triangles are there in the following figure?

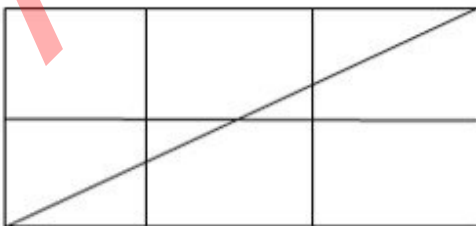

Ans  1. 8

2. 5

3. 7

4. 6

Q.7 A paper is folded and cut as shown below. How will it appear when unfolded?

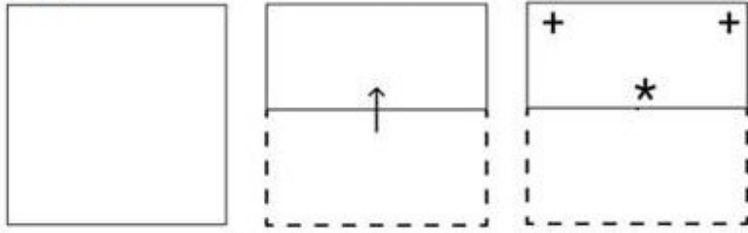

Ans

✗ 1.

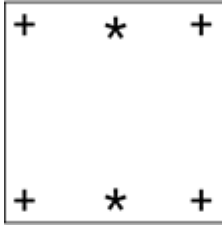

✓ 2.

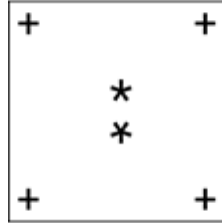

✗ 3.

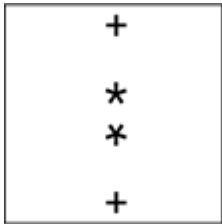

✗ 4.

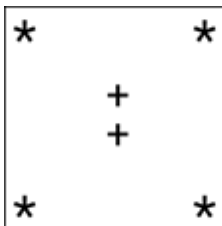

Q.8 What should come in place of the question mark (?) in the given series based on the English alphabetical order?  
YAU, DFZ, IKE, NPJ, ?

Ans ✓ 1. SUO

✗ 2. RUS

✗ 3. SOU

✗ 4. SRU

Q.9 Select the correct mirror image of the given combination when the mirror is placed at MN as shown below.

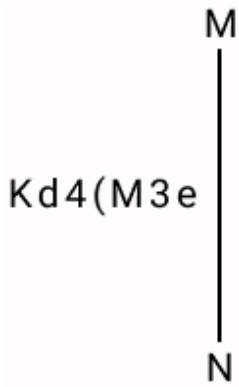

- Ans
- 1. Kq4(3Me
  - 2. K4p(M3e
  - 3. Kd4(M3e
  - 4. Kq4(M3e

Q.10 If the seventh day of a month is three days earlier than Friday, then what day will it be on the 20th day of the month?

- Ans
- 1. Thursday
  - 2. Tuesday
  - 3. Monday
  - 4. Wednesday

Q.11 Which of the following numbers will replace the question mark (?) in the given series?

67 100 146 179 225 258 ?

- Ans
- 1. 325
  - 2. 318
  - 3. 292
  - 4. 304

Q.12 Three of the following four are alike in a certain way and thus form a group. Which is the one that does NOT belong to that group?

(Note: The odd one out is not based on the number of consonants/vowels or their position in the letter cluster.)

- Ans
- 1. GJN
  - 2. RVZ
  - 3. LPT
  - 4. BFJ

Q.13 Select the correct mirror image of the given figure when the mirror is placed at MN, as shown.

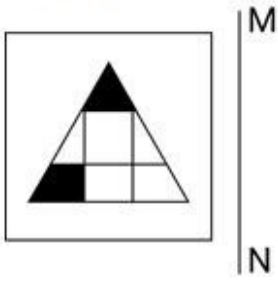

Ans

✗ 1.

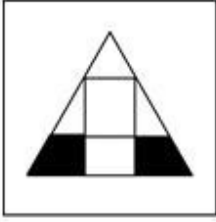

✗ 2.

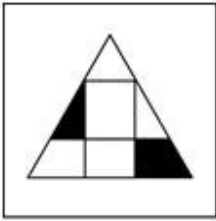

✗ 3.



✓ 4.

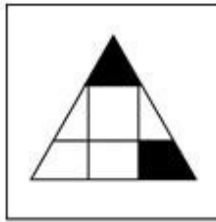

Q.14 What would be the number on the opposite side of '30' if the given sheet is folded to form a cube?



Ans

✗ 1. 27

✗ 2. 29

✗ 3. 28

✓ 4. 26

Q.15 99 is related to 77.3 following a certain logic. Following the same logic, 84.4 is related to 62.7. To which of the following 72.6 is related, following the same logic?

- Ans
- 1. 52.7
  - 2. 50.9
  - 3. 57.3
  - 4. 54.2

Q.16 Select the word-pair that best represents a similar relationship to the one expressed in the pair of words given below.

(The words must be considered as meaningful English words and must not be related to each other based on the number of letters/consonants/vowels in the word.)

Problem : Solution

- Ans
- 1. Lost : Found
  - 2. Time : Money
  - 3. Success : Fame
  - 4. Talk : Speak

Q.17 If 'E' stands for '×', 'O' stands for '+', 'U' stands for '-' and 'V' stands for '÷', what will come in place of the question mark (?) in the following equation?

$$12 V 2 O 36 E 48 U 53 = ?$$

- Ans
- 1. 3142
  - 2. 1650
  - 3. 6234
  - 4. 1681

Q.18 What will come in the place of '?' in the following equation if '+' and '-' are interchanged and '×' and '÷' are interchanged?  
 $21 + 23 - 46 \times 23 \div 21 = ?$

- Ans
- 1. 90
  - 2. 65
  - 3. 78
  - 4. 40



Q.19 Select the option in which the given figure is embedded (rotation is not allowed).

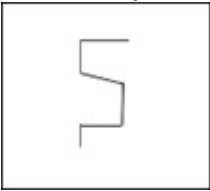

Ans

✓ 1.

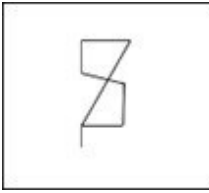

✗ 2.

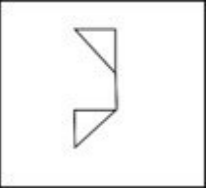

✗ 3.

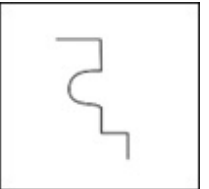

✗ 4.

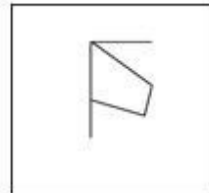

Adda247 Marathi

**Q.20** Identify the figure given in the options that when put in place of the question mark (?) will logically complete the series.

X	I	□	X	C	□	I	C	?
T	C	T	T	X	X	T		
C			X					
□	3	3	I	I	3	3	□	

**Ans**

✓ 1.

X	I
T	C
□	3

✗ 2.

□	3
I	X
C	T

✗ 3.

X	3
T	□
C	I

✗ 4.

C	X
T	□
I	3

**Q.21** In a certain code language, 'no way out' is written as 'rp ab lm' and 'out of house' is written as 'mr rp bd'. How is 'out' written in the given language?

**Ans**

✗ 1. ab

✓ 2. rp

✗ 3. lm

✗ 4. mr

**Q.22** Select the word-pair that best represents a similar relationship to the one expressed in the pair of words given below.

(The words must be considered as meaningful English words and must not be related to each other based on the number of letters/number of consonants/vowels in the word)

Honest : Corrupt

**Ans**

✗ 1. Observe : Watch

✓ 2. Strong : Fragile

✗ 3. Admire : Respect

✗ 4. Scarce : Rare

Q.23 HF 16 is related to KI 8 in a certain way. In the same way, RP 10 is related to US 5. To which of the following is NL 6 related, following the same logic?

- Ans
- 1. QS 2
  - 2. OQ 2
  - 3. LJ 3
  - 4. QO 3

Q.24 In a certain code language, 'love to god' is coded as 'xr od yk' and 'god bless you' is coded as 'tc ap od'. How is 'god' coded in the given language?

- Ans
- 1. od
  - 2. yk
  - 3. tc
  - 4. ap

Q.25 Which of the following letter-clusters can replace the question mark (?) in the given series to make it logically complete? PQR, RTV, TWZ, VZD, ?

- Ans
- 1. YCZ
  - 2. WXT
  - 3. OPS
  - 4. XCH

Section : Quantitative Aptitude

Q.1 On dividing a certain number by 304, we get 43 as the remainder. If the same number is divided by 16, what will be the remainder?

- Ans
- 1. 8
  - 2. 11
  - 3. 15
  - 4. 12

Q.2 The sum of the five consecutive even numbers is 2720. The sum of the third and fifth numbers is:

- Ans
- 1. 1192
  - 2. 1292
  - 3. 1092
  - 4. 1392

3. An electric vehicle company produces three different car models: A, B and C. The production of three different models over a period of four years has been shown in the bar graph below.

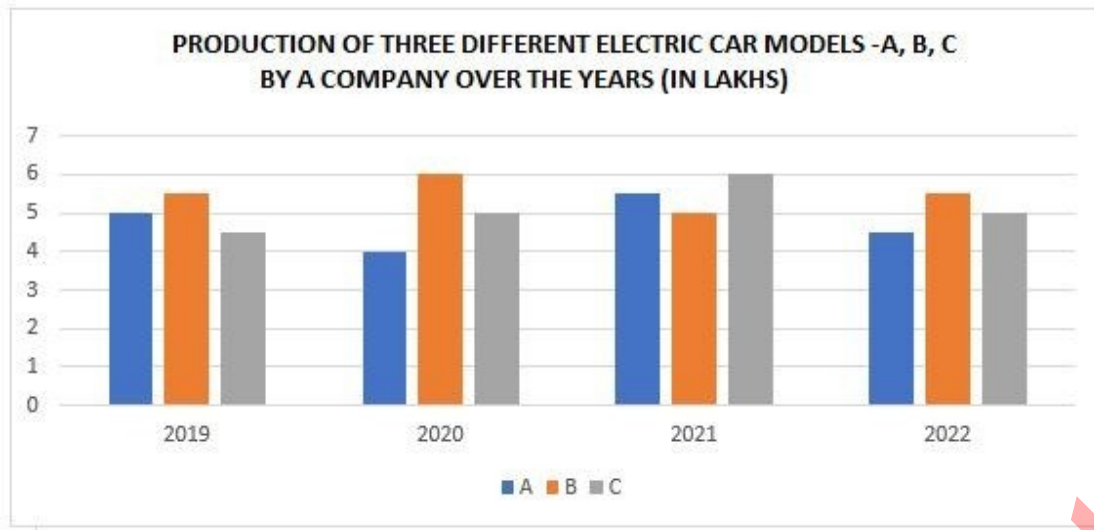

What is the difference between the average production of Model A in 2019, 2021 and 2022 and the average production of Model B in 2020, 2021 and 2022?

- Ans
- 1. 95,000 cars
  - 2. 80,000 cars
  - 3. 45,000 cars
  - 4. 50,000 cars

Q.4 A hemisphere has a radius of 6.2 cm. Find its total surface area (use  $\pi = 3.14$ ) (round off to two decimal places).

- Ans
- 1. 282.25 cm<sup>2</sup>
  - 2. 358.52 cm<sup>2</sup>
  - 3. 276.35 cm<sup>2</sup>
  - 4. 362.10 cm<sup>2</sup>

Q.5 Consider two concentric circles having radii 17 cm and 15 cm. What is the length (in cm) of the chord, of the bigger circle, which is a tangent to the smaller circle?

- Ans
- 1. 16
  - 2. 10
  - 3. 12
  - 4. 8

Q.6 The volume of a cube is reduced to 72.9%. By how much is the side of the cube reduced?

- Ans
- 1. 9.5%
  - 2. 10%
  - 3. 8.5%
  - 4. 9%

Q.7 When a number is increased by 8, it becomes 120% of itself. The number is:

- Ans
- 1. 30
  - 2. 40
  - 3. 60
  - 4. 50

Q.8 What is the effective discount percentage if a shopkeeper offers a scheme discount 'buy five and get one free'?

- Ans
- 1. 15.67%
  - 2. 16.67%
  - 3. 16.33%
  - 4. 15.33%

Q.9 Simplify the following expression.

$$(3 - 3 \times 3 + 3 \div 3 + 3 \times 5) \times 2 \text{ of } 5 + (2 + 2 \div 2 + 2 \times 2 - 2)$$

- Ans
- 1. 102
  - 2. 100
  - 3. 106
  - 4. 105

Q.10 Read the given information and answer the question that follows.

The following table gives the percentage of marks obtained by seven students in six different subjects in an examination.

The number in the brackets gives the maximum marks in each subject.

Student	Subject (Max. Marks)					
	Maths	Chemistry	Physics	Geography	History	Computer Science
	(150)	(130)	(120)	(100)	(60)	(40)
Ayush	90	50	90	60	70	80
Aman	100	80	80	40	80	70
Sajal	90	60	70	70	90	70
Rohit	80	65	80	80	60	60
Muskan	80	65	85	95	50	90
Tanvi	70	75	65	85	40	60
Tarun	65	35	50	77	80	80

What is the total raw score obtained by Rohit?

- Ans
- 1. 425
  - 2. 444.5
  - 3. 430.5
  - 4. 440.5

Q.11 47 masons can dig a 35 m long trench in one day. How many masons should be employed for digging a 105 m long trench of the same type in one day?

- Ans
- 1. 94
  - 2. 141
  - 3. 128
  - 4. 70

Q.12 The simple interest on a sum of money for  $1\frac{1}{2}$  years at 10% per annum is ₹30 more than the simple interest on the same sum for 1 year at 12% per annum. Find the sum.

- Ans
- 1. ₹1,000
  - 2. ₹1,050
  - 3. ₹1,250
  - 4. ₹1,200

Q.13 Moving at  $\frac{6}{7}$  of its usual speed, a bus is 20 minutes late. What is its usual time to cover the journey?

- Ans
- 1. 2 hours
  - 2. 4 hours
  - 3. 1.5 hours
  - 4. 3 hours

Q.14 The average monthly expenditure of a family was ₹2,500 during the first 4 months, ₹2,750 during the next 5 months and ₹3,550 during the last 3 months of a year. If the total saving during the year was ₹5,500, what was the average monthly income of the family?

- Ans
- 1. ₹3,325
  - 2. ₹4,375
  - 3. ₹5,790
  - 4. ₹7,355

Q.15 The distance between the centres of two circles of radii 4 cm and 2 cm is 10 cm. The length (in cm) of a transverse common tangent is:

- Ans
- 1. 13
  - 2. 11
  - 3. 6
  - 4. 8

Q.16 If the brick size is 25 cm×12 cm×9 cm, then how many bricks are required to construct a wall of length 10 m, breadth 22.5 cm and height 6 m?

- Ans
- 1. 6000
  - 2. 4500
  - 3. 5000
  - 4. 8000

Q.17

Study the given bar-graph and answer the question that follows.

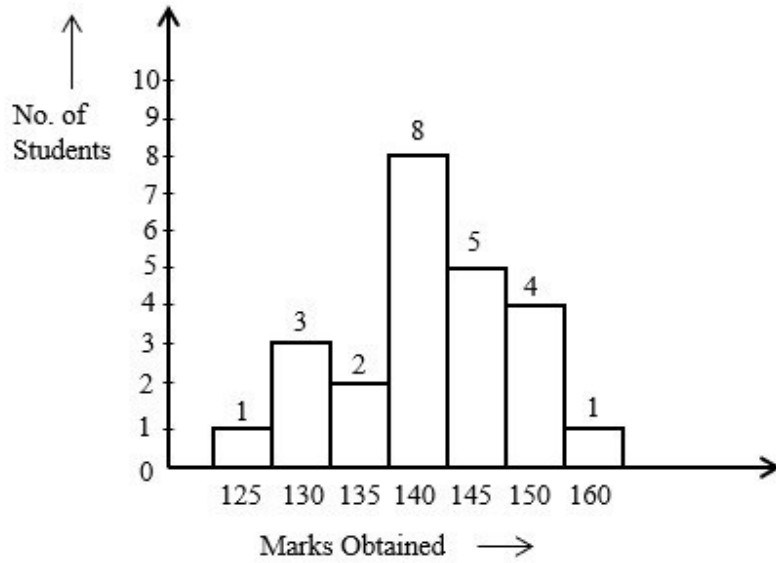

How many students obtained less than the average marks of the class?

Ans

✓ 1. 14

✗ 2. 6

✗ 3. 11

✗ 4. 10

Q.18

Given that  $\sin \theta = \frac{15}{17}$ , Evaluate  $\frac{15 \cot \theta + 17 \sin \theta}{8 \tan \theta + 16 \sec \theta}$ , where  $0^\circ < \theta < 90^\circ$ .

Ans

✓ 1.  $\frac{23}{49}$

✗ 2.  $\frac{49}{23}$

✗ 3.  $\frac{49}{26}$

✗ 4.  $\frac{26}{23}$

Q.19

Study the given pie-chart and answer the question that follows.

The pie-chart shows the monthly expenditure incurred by a family on various items and their savings.

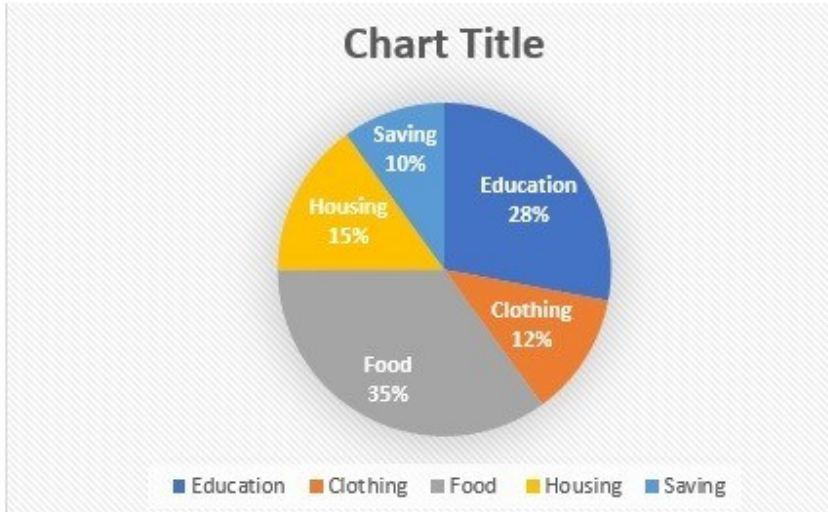

If the total expenditure is ₹84,000, then what is the expenditure on food (in ₹)?

- Ans
- 1. 29400
  - 2. 23500
  - 3. 19400
  - 4. 27400

Q.20 Two equal circles are drawn on a square in such a way that opposite side of the square forms the diameter of each circle. If the remaining area of the square is  $42 \text{ cm}^2$ , what is the measurement (in cm) of the diameter of each circle?

- Ans
- 1. 3.5
  - 2. 2.5
  - 3. 14
  - 4. 7

Q.21 If 70% of the cost price of an article is equal to 40% of its selling price, what is the profit percentage?

- Ans
- 1. 75%
  - 2. 45%
  - 3. 85%
  - 4. 20%

Q.22 From the salary of a software engineer, if 15% is used as house rent, 25% of the remaining is spent on household items, 25% of the remaining as income tax, and 15% of the remaining on clothing, then he is left with ₹10,404. Find his total salary.

- Ans
- 1. ₹22,600
  - 2. ₹24,600
  - 3. ₹25,600
  - 4. ₹23,600

Q.23 If the side of a square is increased by 5%, then the percentage increase in its area will be:

- Ans
- 1. 10%
  - 2. 11%
  - 3. 10.5%
  - 4. 10.25%



Q.24 If 35 is the mean proportional of 25 and x, then what is value of x?

- Ans
- 1. 46
  - 2. 47
  - 3. 49
  - 4. 48

Q.25 If  $\Delta ABC$  and  $\Delta PQR$  are similar.  $AB = 8$  cm,  $PQ = 12$  cm,  $QR = 18$  cm and  $RP = 24$  cm, then the perimeter of  $\Delta ABC$  is \_\_\_\_\_ cm.

- Ans
- 1. 27
  - 2. 36
  - 3. 42
  - 4. 54

Section : General Awareness

Q.1 The Industrial Policy Resolution, 1948 mainly categorised the large-scale industries into \_\_\_\_\_ fragments.

- Ans
- 1. three
  - 2. four
  - 3. two
  - 4. five

2. Which of the following statements are INCORRECT vis-à-vis features of the Indian Constitution?  
1) The Constitution empowers the Prime Minister to proclaim three types of emergencies.  
2) A reservation policy is there to uplift the disadvantaged sections of society.  
3) The Supreme Court has no power of judicial review.  
4) The Constitution provides for universal adult suffrage.

- Ans
- 1. 2 and 4
  - 2. 1 and 3
  - 3. 1 and 2
  - 4. 3 and 4

3. Who is the only Indian woman who has been ranked world's no.1 for badminton?

- Ans
- 1. P.V Sindhu
  - 2. Rituparna Das
  - 3. Jwala Gutta
  - 4. Saina Nehwal

Q.4 Which famous book was written by 'Haripala'?

- Ans
- 1. Sangeeta Sudhakara
  - 2. Sangeet Darpan
  - 3. Sangeet Ratnakara
  - 4. Gita Govinda

Q.5 Which of the following is an example of a 'solid in a liquid' type of solution?

- Ans
- 1. Tincture of iodine
  - 2. Vinegar
  - 3. Brass
  - 4. Bronze

Q.6 In September 2022 the book 'Ambedkar and Modi: Reformer's Ideas Performer's Implementation' has been written by which of the following personalities?

- Ans
- 1. Sarvepalli Radhakrishnan
  - 2. APJ Abdul Kalam
  - 3. Ram Nath Kovind
  - 4. Pratibha Patil

Q.7 According to Census of India 2011, how many districts are there in India?

- Ans
- 1. 620
  - 2. 640
  - 3. 630
  - 4. 610

Q.8 Mahabalipuram temple was built under the reign of which of the following dynasties?

- Ans
- 1. Rashtrakuta
  - 2. Pratihara
  - 3. Chola
  - 4. Pallava

Q.9 Which folk music does NOT belong to Nagaland?

- Ans
- 1. Nyioga
  - 2. Hereileu
  - 3. Heliamleu
  - 4. Neuleu

Q.10 Article 20 of the Constitution of India is related to \_\_\_\_\_.

- Ans
- 1. protection in respect of conviction for offenses
  - 2. abolition of titles
  - 3. equality of opportunities in matters of public employment
  - 4. freedom to manage religious affairs

Q.11 Which of the following is NOT a poverty alleviation programme in India?

- Ans
- 1. Swarna Jayanti Shahari Rozgar Yojana
  - 2. Rashtriya Uchatar Shiksha Abhiyan
  - 3. Integrated Rural Development Program
  - 4. Prime Minister Rozgar Yojana

Q.12 On what type of data can MS Excel functions operate?

- Ans
- 1. External data sources only
  - 2. Range of cells or groups of cells
  - 3. Entire worksheets only
  - 4. Individual cells only

Q.13 Which of the following was NOT a venue for the 66<sup>th</sup> National School Games 2022-23?

- Ans
- 1. Delhi
  - 2. Gwalior
  - 3. Bhopal
  - 4. Ludhiana

Q.14 Which of the following groups of places in India has little differences in day and night temperatures?

- Ans
- 1. Bhopal and Indore
  - 2. Chennai and Thiruvananthapuram
  - 3. Jammu and Kashmir
  - 4. Jaipur and Jaisalmer

Q.15 Which of the following is the festival of Kerala that heralds the harvest season, lasts for 10 days, and has snake boat races etc?

- Ans
- 1. Thiruvathira
  - 2. Onam
  - 3. Thrissur Pooram
  - 4. Vishu

Q.16 When was the Bharat Nirman Programme launched by the Government of India?

- Ans
- 1. 2010
  - 2. 2014
  - 3. 2005
  - 4. 2000

Q.17 'Chhau' is a popular dance of which of the following state?

- Ans
- 1. Gujarat
  - 2. Kerala
  - 3. Haryana
  - 4. Jharkhand

Q.18 What is the main objective of Fiscal Responsibility and Budget Management Act (FRBMA), 2003?

- Ans
- 1. To reduce subsidies
  - 2. To increase exports
  - 3. To reduce fiscal deficit
  - 4. To increase excise duty

Q.19 How do the muscle cells help in movement?

- Ans
- 1. The lining of the vessels inside help in movement.
  - 2. The contraction and relaxation of these cells result in movement.
  - 3. The blood flow of the cells helps in movement.
  - 4. The thickness of the cell layer helps in movement.

Q.20 What will happen when you select the cell contents of a particular row in MS-Excel and then click the Delete button?

- Ans
- 1. Entries in all the selected cells will be deleted
  - 2. Only first three cells will be deleted
  - 3. Entire row will be deleted
  - 4. First five cell entries will be deleted

Q.21 The Reserve Bank of India was fully nationalised and owned by the Government of India in which of the following years?

- Ans
- 1. 1949
  - 2. 1950
  - 3. 1947
  - 4. 1948

Q.22 Orographic rainfall occurs when \_\_\_\_\_.

- Ans
- 1. a cyclone makes a landfall
  - 2. the air masses collide at Intertropical Conversion Zone
  - 3. saturated air mass comes across a mountain
  - 4. hot air rises up in conventional currents

Q.23 The fifth edition of the Khelo India Youth Games were organised in Bhopal city in which year?

- Ans
- 1. 2022
  - 2. 2020
  - 3. 2021
  - 4. 2023

Q.24 In April 2023, Government of India launched Vibrant Village Programme from Kibithoo village which is located in \_\_\_\_\_.

- Ans
- 1. Meghalaya
  - 2. Bihar
  - 3. Arunachal Pradesh
  - 4. Assam

Q.25 In July 2021, which state government passed a resolution supporting an ad hoc committee report that favoured the creation of a legislative council?

- Ans
- 1. West Bengal
  - 2. Bihar
  - 3. Telangana
  - 4. Odisha

## Combined Higher Secondary Level Examination 2024 Tier I

Exam Date	02/07/2024
Exam Time	2:30 PM - 3:30 PM
Subject	CHSL Exam 2024 Tier I

### Section : English Language

1. Select the option that corrects the following sentence.  
What are you looking around?

Ans  1. What are you looking among?  
 2. What are you looking for?  
 3. What are you looking across?  
 4. What are you looking through?

2. The following sentence has been divided into four segments. Identify the segment that contains an error in the usage of indefinite articles.  
We took / an ice / and applied it on / the wound.

Ans  1. an ice  
 2. We took  
 3. and applied it on  
 4. the wound.

3. The following sentence has been split into four segments. Identify the segment that contains a grammatical error. Since the little girl answers / a few simple questions, / her parents say that / she is too intelligent.

Ans  1. Since the little girl answers  
 2. her parents say that  
 3. she is too intelligent  
 4. a few simple questions

- Q.4 The following sentence has been split into four segments. Identify the segment that contains a grammatical error.

It is difficult to live in / the societal expectations / when one has / fewer resources.  
A B C D

Ans  1. B  
 2. A  
 3. D  
 4. C

**Comprehension:**

In the following passage, some words have been deleted. Read the passage carefully and select the most appropriate option to fill in each blank.

Cities are the great havens for knowledge, culture, and social life. Vibrant cultures are found in cities because it takes a 1. \_\_\_\_\_ population to support museums, concert halls, sports teams, and night-life districts. Cities also offer rich social opportunities. People in rural areas enjoy only limited social opportunities because 2. \_\_\_\_\_ the small local population. City dwellers can choose their friends and mates from among a large number of people of 3. \_\_\_\_\_ interests and inclinations. We are not likely to abandon the city as a 4. \_\_\_\_\_ institution, but we need to make sure that our transport arrangements do not 5. \_\_\_\_\_ the 'city's' other functions.

**SubQuestion No : 5**

**Q.5** Select the most appropriate option to fill in blank No. 1.

- Ans**
- 1. large
  - 2. small
  - 3. lazy
  - 4. dumb

**Comprehension:**

In the following passage, some words have been deleted. Read the passage carefully and select the most appropriate option to fill in each blank.

Cities are the great havens for knowledge, culture, and social life. Vibrant cultures are found in cities because it takes a 1. \_\_\_\_\_ population to support museums, concert halls, sports teams, and night-life districts. Cities also offer rich social opportunities. People in rural areas enjoy only limited social opportunities because 2. \_\_\_\_\_ the small local population. City dwellers can choose their friends and mates from among a large number of people of 3. \_\_\_\_\_ interests and inclinations. We are not likely to abandon the city as a 4. \_\_\_\_\_ institution, but we need to make sure that our transport arrangements do not 5. \_\_\_\_\_ the 'city's' other functions.

**SubQuestion No : 6**

**Q.6** Select the most appropriate option to fill in blank No. 2.

- Ans**
- 1. off
  - 2. with
  - 3. of
  - 4. for

**Comprehension:**

In the following passage, some words have been deleted. Read the passage carefully and select the most appropriate option to fill in each blank.

Cities are the great havens for knowledge, culture, and social life. Vibrant cultures are found in cities because it takes a 1. \_\_\_\_\_ population to support museums, concert halls, sports teams, and night-life districts. Cities also offer rich social opportunities. People in rural areas enjoy only limited social opportunities because 2. \_\_\_\_\_ the small local population. City dwellers can choose their friends and mates from among a large number of people of 3. \_\_\_\_\_ interests and inclinations. We are not likely to abandon the city as a 4. \_\_\_\_\_ institution, but we need to make sure that our transport arrangements do not 5. \_\_\_\_\_ the 'city's' other functions.

**SubQuestion No : 7**

**Q.7** Select the most appropriate option to fill in blank No. 3.

- Ans**
- 1. wasteful
  - 2. declining
  - 3. similar
  - 4. feigning

**Comprehension:**

In the following passage, some words have been deleted. Read the passage carefully and select the most appropriate option to fill in each blank.

Cities are the great havens for knowledge, culture, and social life. Vibrant cultures are found in cities because it takes a 1. \_\_\_\_\_ population to support museums, concert halls, sports teams, and night-life districts. Cities also offer rich social opportunities. People in rural areas enjoy only limited social opportunities because 2. \_\_\_\_\_ the small local population. City dwellers can choose their friends and mates from among a large number of people of 3. \_\_\_\_\_ interests and inclinations. We are not likely to abandon the city as a 4. \_\_\_\_\_ institution, but we need to make sure that our transport arrangements do not 5. \_\_\_\_\_ the 'city's' other functions.

**SubQuestion No : 8**

**Q.8** Select the most appropriate option to fill in blank No. 4.

- Ans
- 1. psychological
  - 2. educational
  - 3. cultural
  - 4. religious

**Comprehension:**

In the following passage, some words have been deleted. Read the passage carefully and select the most appropriate option to fill in each blank.

Cities are the great havens for knowledge, culture, and social life. Vibrant cultures are found in cities because it takes a 1. \_\_\_\_\_ population to support museums, concert halls, sports teams, and night-life districts. Cities also offer rich social opportunities. People in rural areas enjoy only limited social opportunities because 2. \_\_\_\_\_ the small local population. City dwellers can choose their friends and mates from among a large number of people of 3. \_\_\_\_\_ interests and inclinations. We are not likely to abandon the city as a 4. \_\_\_\_\_ institution, but we need to make sure that our transport arrangements do not 5. \_\_\_\_\_ the 'city's' other functions.

**SubQuestion No : 9**

**Q.9** Select the most appropriate option to fill in blank No. 5.

- Ans
- 1. boost
  - 2. help
  - 3. damage
  - 4. support

**Q.10** Select the most appropriate option that can substitute the underlined segment in the given sentence. If there is no need to substitute it, select 'No substitution required'.

Then I unfurled the Indian tri-colour and keep it aloft at the roof of the world.

- Ans
- 1. keeping
  - 2. held
  - 3. No substitution required
  - 4. hold

**Q.11** Select the most appropriate ANTONYM of the underlined word.

She was known for her refined manners.

- Ans
- 1. Crude
  - 2. Elegant
  - 3. Shrewd
  - 4. Brood

**Q.12** Select the most appropriate homonym to fill in the blank.

Ravi is \_\_\_\_\_.

- Ans
- 1. bawled
  - 2. balled
  - 3. baled
  - 4. bald

Q.13 Select the most appropriate idiom to fill in the blank.  
After a day long trek, we were so tired that we were ready to \_\_\_\_\_.

- Ans
- 1. face the music
  - 2. get into deep water
  - 3. go from rags to riches
  - 4. hit the sack

Q.14 Select the most appropriate synonym of the word 'intuitive' to fill in the blank.  
In a split second, her \_\_\_\_\_ reaction kicked in as she swiftly reached out to catch the falling glass.

- Ans
- 1. shrewd
  - 2. instinctive
  - 3. voluntary
  - 4. insightful

Q.15 Select the most appropriate synonym of the word 'Abandon' from the given sentence.

Ramita has decided to forsake her participation in college activities until she improved her scores.

- Ans
- 1. forsake
  - 2. improved
  - 3. decided
  - 4. participation

Q.16 Select the most appropriate idiom to fill in the blank.

The two brothers \_\_\_\_\_ when their father died.

- Ans
- 1. fell down
  - 2. fell out
  - 3. got the sack
  - 4. look down upon

Q.17 Select the most appropriate option that can substitute the underlined segment in the given sentence.

One of my best friends are here.

- Ans
- 1. better friends are here
  - 2. best friends is here
  - 3. better friends is here
  - 4. best friend is here

Q.18 Select the most appropriate synonym of the underlined word in the given sentence.

We should not discriminate against people who are different from us.

- Ans
- 1. differentiate
  - 2. divide
  - 3. part
  - 4. sever

Q.19 Select the most appropriate option to fill in the blank.

The teacher asked the students to \_\_\_\_\_ electricity by switching off lights when they left the room.

- Ans
- 1. save
  - 2. deposit
  - 3. rescue
  - 4. retain



Q.20 Select the option that will improve the underlined part of the given sentence.

This book provides an unrestrained account of the natural resources in India.

- Ans
- 1. exhausting
  - 2. limited
  - 3. exhaustive
  - 4. excessive

Q.21 Select the most appropriate ANTONYM of the underlined word in the given sentence.  
The truth was revealed in the interrogation.

- Ans
- 1. Evident
  - 2. Found
  - 3. Declared
  - 4. Concealed

Q.22 Select the most appropriate ANTONYM of the underlined word.  
We should desecrate our national flag.

- Ans
- 1. Integrate
  - 2. Sanctify
  - 3. Violate
  - 4. Damage

Q.23 Select the option that will improve the underlined part of the given sentence. In case no improvement is needed, select 'No improvement'.  
The Privacy Shield establishes a process to allow companies to transfer consumer data from European Union countries to the United States in compliance in EU law.

- Ans
- 1. No improvement
  - 2. in compliance for the
  - 3. in compliance under the
  - 4. in compliance with

Q.24 Identify the incorrectly spelt word and select its correct spelling.  
This will sound weired, but bear with me.

- Ans
- 1. wired
  - 2. beer
  - 3. weird
  - 4. bier

Q.25 Select the INCORRECTLY spelt word.

- Ans
- 1. Betrey
  - 2. Destroy
  - 3. Develop
  - 4. Demolish

Q.1 How many semi circles are there in the given figure?

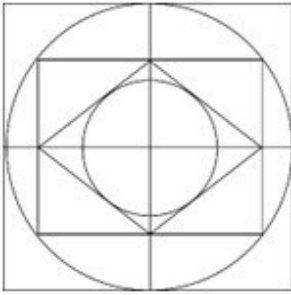

- Ans
- 1. 8
  - 2. 12
  - 3. 10
  - 4. 9

Q.2 'ETHICS' is related to 'AVDKYU' in a certain way based on the English alphabetical order. In the same way, 'CUSTOM' is related to 'YWOVKO'. To which of the following is 'PRINCIPLES' related, following the same logic?

- Ans
- 1. LSEPYKLNAU
  - 2. LTEPYKLNAU
  - 3. LTFPYKLNAU
  - 4. LTEPYKLMAU

Q.3 45 is related to 100 following a certain logic. Following the same logic, 65 is related to 140. To which of the following is 105 related, following the same logic?

(NOTE: Operations should be performed on the whole numbers, without breaking down the numbers into their constituent digits. E.g. 13 – Operations on 13 such as adding /subtracting /multiplying to 13 can be performed. Breaking down 13 into 1 and 3 and then performing mathematical operations on 1 and 3 is not allowed.)

- Ans
- 1. 210
  - 2. 215
  - 3. 220
  - 4. 230

Q.4 Three of the following letter-clusters are alike in some manner and hence form a group. Which letter-cluster does not belong to that group?

(Note: The odd one out is not based on the number of consonants/vowels or their position in the letter cluster.)

- Ans
- 1. TBG
  - 2. CKP
  - 3. LTY
  - 4. EMS

Q.5 Identify the figure in the options that when put in place of the question mark (?) will logically complete the series?

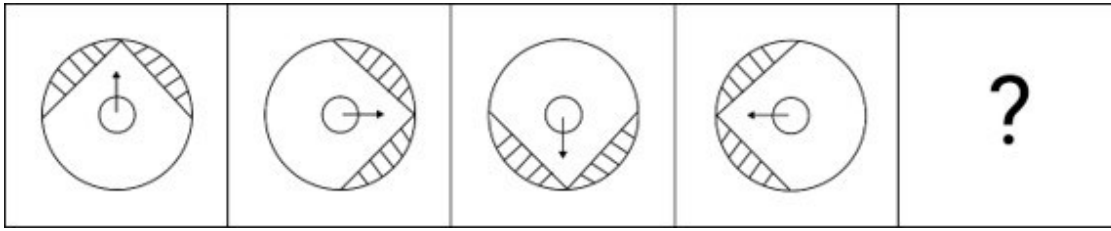

Ans

✗ 1.

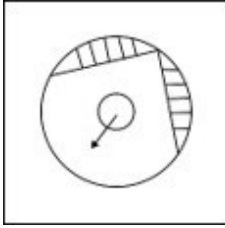

✓ 2.

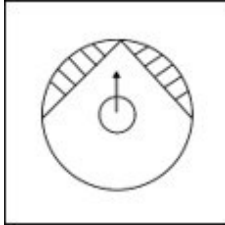

✗ 3.

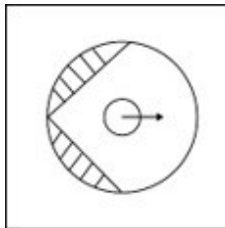

✗ 4.

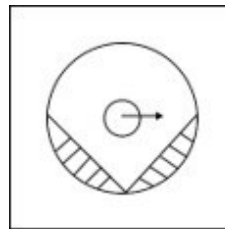

Q.6 What should come in place of ? in the given series based on the English alphabetical order?

YQI CZQ GIY KRG ?

Ans

✗ 1. DMX

✗ 2. EOZ

✓ 3. OAO

✗ 4. CNY

Q.7 Select the option in which the given figure is embedded (rotation is not allowed).

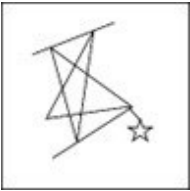

Ans

✗ 1.

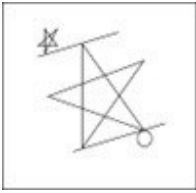

✗ 2.

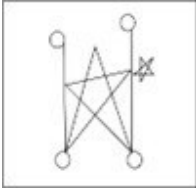

✓ 3.



✗ 4.

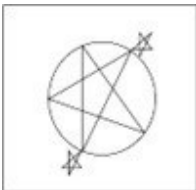

Q.8 Which two numbers should be interchanged to make the given equation correct?

$$8 \times (7 + 5 - 3) + (46 \div 23) \times 6 - 69 = 44$$

(NOTE: Numbers must be interchanged and not the constituent digits e.g. if 2 and 3 are to be interchanged in the equation  $43 \times 3 + 4 \div 2$ , then interchanged equation is  $43 \times 2 + 4 \div 3$ )

Ans

✗ 1. 6 and 7

✗ 2. 3 and 5

✓ 3. 46 and 69

✗ 4. 8 and 6

Q.9 The position of how many letters will remain unchanged, if each of the letters in the word DICTIONARY is arranged in alphabetical order?

Ans

✗ 1. 4

✗ 2. 1

✗ 3. 3

✓ 4. 2

Q.10 In a certain code language, 'tiffin is heavy' is written as 'ct qm lb' and 'heavy weight gain' is written as 'rx yb ct'. How is 'heavy' written in the given language?

Ans

✓ 1. ct

✗ 2. qm

✗ 3. lb

✗ 4. rx

**Q.11** Three statements are followed by conclusions numbered I, II. You have to consider these statements to be true, even if they seem to be at variance with commonly known facts. Decide which of the given conclusions logically follows from the given statement.

**Statements:**

Some bottles are pens.

All pens are tables.

All tables are glasses.

**Conclusion (I):** Some glasses are bottles.

**Conclusion (II):** Some pens are glasses.

- Ans**
- 1. Only conclusion (I) follows.
  - 2. Only conclusion (II) follows.
  - 3. Both conclusions (I) and (II) follow.
  - 4. Neither conclusion (I) nor (II) follows.

**Q.12** In a certain code language,  
'A + B' means 'A is the mother of B',  
'A - B' means 'A is the brother of B',  
'A × B' means 'A is the father of B',  
'A ÷ B' means 'A is the daughter of B'  
Based on the above, how is E related to A if 'A × B - C + D ÷ E'?

- Ans**
- 1. Brother
  - 2. Daughter's husband
  - 3. Son
  - 4. Wife's brother

**Q.13** What should come in place of the question mark (?) in the given series?

27, 32, 42, 47, 57, ?

- Ans**
- 1. 62
  - 2. 60
  - 3. 61
  - 4. 63

Q.14 Select the option figure in which the given figure (X) is embedded as its part (rotation is NOT allowed).

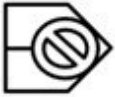

(X)

Ans

1.



2.

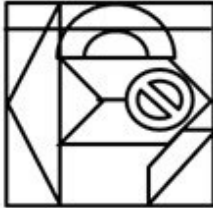

3.

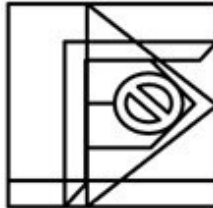

4.

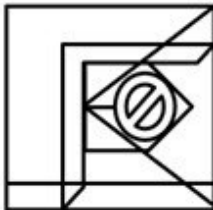

Q.15 If 'A' stands for '+', 'B' stands for 'x', 'C' stands for '+' and 'D' stands for '-', then the resultant of which of the following will be 233?

Ans  1. 21 C 11 D 33 A 11 B 5

2. 21 A 11 D 33 B 11 C 5

3. 21 B 11 D 33 A 11 C 5

4. 21 B 11 A 33 D 11 C 5

Q.16 Which of the following numbers will replace the question mark (?) in the given series?

12, 26, 54, ?, 222, 446

Ans  1. 98

2. 94

3. 88

4. 110

Q.17 In a certain code language, 'INDULGE' is coded as '48' and 'PURGE' is coded as '24'. How will 'PUNY' be coded in that language?

Ans  1. 25

2. 20

3. 18

4. 15

Q.18 The sequence of folding a piece of paper and the manner in which the folded paper is punched is shown in the following figures. How would this paper look when unfolded?

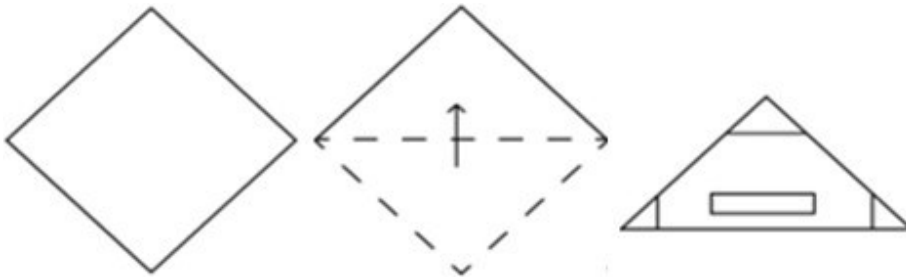

Ans

- 1.
- 2.
- 3.
- 4.

Q.19 If 24 August 1932 was a Wednesday, then what was the day of the week on 11 September 1943?

- Ans
- 1. Monday
  - 2. Saturday
  - 3. Wednesday
  - 4. Sunday

Q.20 Select the correct mirror image of the given figure when the mirror is placed at MN as shown below.



- Ans
- 1. **K B V 2 Y X ʘ C**
  - 2. **C 9 X Y 2 V 8 K**
  - 3. **K B V 2 Y X ʘ C**
  - 4. **K B V 2 Y X ʘ C**

Q.21 LH3 is related to RN21 in a certain way. In the same way, JF5 is related to PL35. To which of the following is ZV6 related following the same logic?

- Ans
- 1. FB45
  - 2. EA45
  - 3. FB42
  - 4. EA24

Q.22 Select the correct mirror image of the given figure when the mirror is placed at MN as shown below.

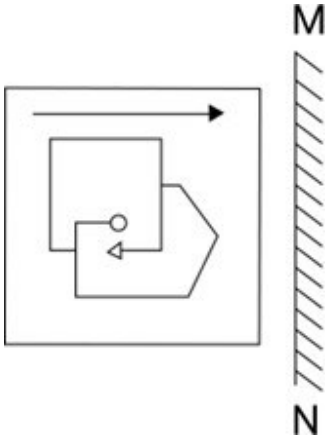

Ans

- 1.
- 2.
- 3.
- 4.



Q.23 What will come in the place of '?' in the following equation, if '+' and '-' are interchanged and '×' and '÷' are interchanged?

$$90 \times 2 - 43 + 7 \div 7 = ?$$

- Ans
- 1. 39
  - 2. 49
  - 3. 29
  - 4. 19

Q.24 Which letter-cluster will replace the question mark (?) to complete the given series?  
NDGB, OFJF, ?, TMSQ, XRYX

- Ans
- 1. QINK
  - 2. QJNK
  - 3. RHNK
  - 4. RINJ

Q.25 Select the set in which the numbers are related in the same way as are the numbers of the following sets.

(26, 38, 128)  
(42, 19, 122)

(NOTE : Operations should be performed on the whole numbers, without breaking down the numbers into its constituent digits. E.g. 13 – Operations on 13 such as adding /subtracting /multiplying etc., to 13 can be performed. Breaking down 13 into 1 and 3 and then performing mathematical operations on 1 and 3 is not allowed.)

- Ans
- 1. (25, 36, 183)
  - 2. (18, 52, 70)
  - 3. (33, 23, 112)
  - 4. (71, 9, 320)

Section : Quantitative Aptitude

Q.1 The given table shows the number of 5 types of cars (Swift, Sx4, Ertiga, Zen, Echo) manufactured (in thousand) by Maruti over the years.

Types of Car					
Year	Swift	Sx4	Ertiga	Zen	Echo
2007	250	200	128	140	115
2008	200	230	150	155	120
2009	230	225	142	160	135
2010	245	210	170	175	125
2011	260	135	180	185	130
2012	275	155	230	220	120

Which type of cars manufactured by Maruti during 2007 to 2012 is the minimum?

- Ans
- 1. Swift
  - 2. Echo
  - 3. Zen
  - 4. Sx4

Q.2 What is the number which needs to be added to 20% of 460 to have the sum as 70% of 920?

- Ans
- 1. 926
  - 2. 762
  - 3. 552
  - 4. 335

Q.3 Simplify the following expression.

$$[40 - 48 \div 4 \text{ of } 3] \div \{(6 + 4) - 4 \text{ of } 4 + 4 + (6 - 4) + (4 \times 4) \div 4\} \times 3.$$

- Ans
- 1. 25
  - 2. 27
  - 3. 30
  - 4. 26

Q.4 Simplify:

$$\{(3^3 + 2^3) \times \frac{22}{7}\} \times \{(6^2 + 3^2 - 4^2) \div (14\frac{1}{2})\}$$

- Ans
- 1. 220
  - 2. 198
  - 3. 110
  - 4. 145

Q.5 The shortest length of the intercept between the x-axis and y-axis of the equation  $6x + 8y - 48 = 0$  is:

- Ans
- 1. 10 units
  - 2. 6 units
  - 3. 14 units
  - 4. 12 units

Q.6 A and B, working together, take 15 days to complete a piece of work. If A alone can do this work in 18 days, then how long would B take to complete the same work?

- Ans
- 1. 33 days
  - 2. 90 days
  - 3. 8 days
  - 4. 15 days

Q.7 The price of an article is first increased by 40% and then decreased by 45%, due to reduction in sales. Find the net percentage change in the final price of the article.

- Ans
- 1. -23%
  - 2. 23%
  - 3. 13%
  - 4. -13%

Q.8 If price of an article increases successively by 15% and 10%, respectively, then what is the percentage equivalent to a single price increase of that article?

- Ans
- ✓ 1. 26.5%
  - ✗ 2. 12.5%
  - ✗ 3. 25%
  - ✗ 4. 23.5%

Q.9 Two quantities are in the ratio 3 : 5. If the first quantity is 155 kg. Find the other quantity (approximately).

- Ans
- ✓ 1. 258.3 kg
  - ✗ 2. 150.5 kg
  - ✗ 3. 200.4 kg
  - ✗ 4. 240.6 kg

Q.10 If  $\Delta ABC \sim \Delta QRP$ ; area of  $\Delta ABC$  : area of  $\Delta PQR = 9 : 4$ ;  $AB = 18$  cm and  $BC = 15$  cm, then find the length of  $PR$ .

- Ans
- ✗ 1. 15 cm
  - ✓ 2. 10 cm
  - ✗ 3. 12 cm
  - ✗ 4. 14 cm

Q.11 Study the given bar-graph and answer the question that follows.  
An electric vehicle company produces three different car models – A, B and C. The production of three different models over a period of four years (in lakhs) has been shown the bar-graph.

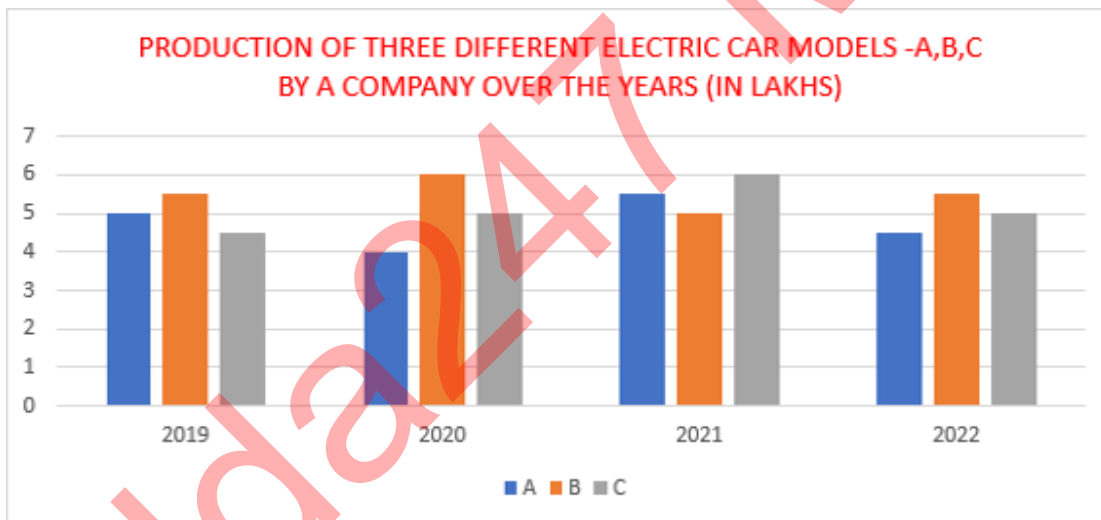

The total production of model C in 2021 and 2022 is what percentage of the total production of model A in 2019 and 2020?

- Ans
- ✗ 1. 102.26%
  - ✗ 2. 105.22%
  - ✗ 3. 115.57%
  - ✓ 4. 122.22%

Q.12 Let  $C$  be a circle with Centre  $O$  and  $P$  be an external point to  $C$ . Let  $PQ$  and  $PR$  be the tangents to  $C$  such that  $Q$  and  $R$  be the points of tangency, respectively. If  $\angle ROQ = 110^\circ$ , find  $\angle RPQ$ .

- Ans
- ✗ 1.  $90^\circ$
  - ✓ 2.  $70^\circ$
  - ✗ 3.  $80^\circ$
  - ✗ 4.  $110^\circ$

Q.13 An iron box with external dimensions 60 cm, 40 cm, and 20 cm is made of 1 cm thick sheet. If  $1 \text{ cm}^3$  of iron weighs 50 gm, the weight of the empty box is:

- Ans
- 1. 214.05 kg
  - 2. 240 kg
  - 3. 400 kg
  - 4. 416.40 kg

Q.14 Two circles of diameters 16 cm and 20 cm are such that the distance between their centers is 13 cm. What is the length (in cm) of a common tangent to these circles that does not intersect the line joining the centers?

- Ans
- 1.  $\sqrt{165}$
  - 2.  $\sqrt{173}$
  - 3.  $\sqrt{167}$
  - 4.  $\sqrt{163}$

Q.15 Find the difference between the curved surface area and total surface area of a right circular cylinder having a length of 68 cm and base diameter of 28 cm.

- Ans
- 1.  $1432 \text{ cm}^2$
  - 2.  $1132 \text{ cm}^2$
  - 3.  $1332 \text{ cm}^2$
  - 4.  $1232 \text{ cm}^2$

Q.16 If the diameter of a hemisphere is 42 cm, then the volume of hemisphere (in  $\text{cm}^3$ ) is:

Take  $\pi = \frac{22}{7}$

- Ans
- 1. 19404
  - 2. 19254
  - 3. 19154
  - 4. 19444

Q.17 Study the given bar-graphs and answer the question that follows.

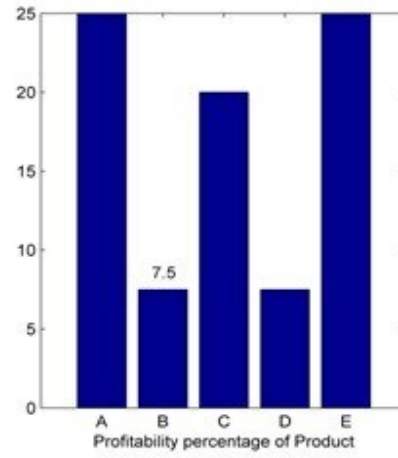
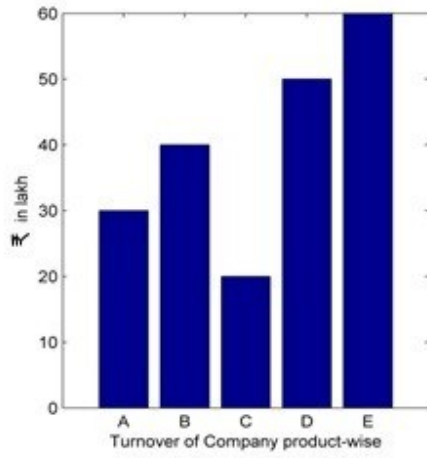

Turnover of Company X (Product-wise: A,B,C,D and E)

Approximately what is the share in the total profit enjoyed by A and E together?

- Ans
- 1. 70%
  - 2. 80%
  - 3. 60%
  - 4. 50%

Q.18 The perimeter of a triangle is 36 units. Its area cannot be more than \_\_\_\_\_ square units.

- Ans
- 1.  $36\sqrt{2}$
  - 2.  $36\sqrt{3}$
  - 3.  $12\sqrt{7}$
  - 4.  $18\sqrt{5}$

Q.19 A shopkeeper marks an article at ₹150 and sells it at a discount of 25%. He also gives a gift worth ₹2.5. If he still makes a 10% profit, then the cost price (in ₹) of the article is:

- Ans
- 1. 100
  - 2. 175
  - 3. 112
  - 4. 125

Q.20 If  $\theta$  is an acute angle and  $\tan\theta + \cot\theta = 2$ , then find the value of  $\tan^3\theta + \cot^3\theta + 6\tan^3\theta\cot^2\theta$ .

- Ans
- 1. 6
  - 2. 10
  - 3. 12
  - 4. 8

Q.21 A policeman received information that a thief is at a distance of 1.5 km from him. The thief starts moving by car and the policeman chases him by car. The thief and the policeman are moving at the speeds of 90 km/h and 120 km/h respectively. At what distance (in km) will the police catch the thief?

- Ans
- 1. 45.0 km
  - 2. 5 km
  - 3. 6 km
  - 4. 4.5 km

Q.22 A shopkeeper bought 288 oranges for ₹115.20. He sold 50 of them at 70 paise each and the remaining at ₹46.20. Find his profit or loss.

- Ans
- 1. Profit, ₹25
  - 2. Loss, ₹34
  - 3. Profit, ₹37
  - 4. Loss, ₹36

Q.23 Mithila covers 50 km by bus in 90 minutes. After deboarding the bus, she takes rest for 15 minutes and covers another 30 km by a taxi in 35 minutes. Find the average speed (in km/h) for the whole journey.

- Ans
- 1.  $31\frac{2}{7}$
  - 2.  $32\frac{2}{7}$
  - 3.  $34\frac{2}{7}$
  - 4.  $33\frac{2}{7}$

Q.24 Find the total amount of debt that will be discharged by 5 equal instalments of ₹200 each, if the debt is due in 5 years at 5% p.a. at simple interest.

- Ans
- 1. ₹1,400
  - 2. ₹1,100
  - 3. ₹1,200
  - 4. ₹1,255

Q.25

Study the given bar-graph and answer the question that follows.

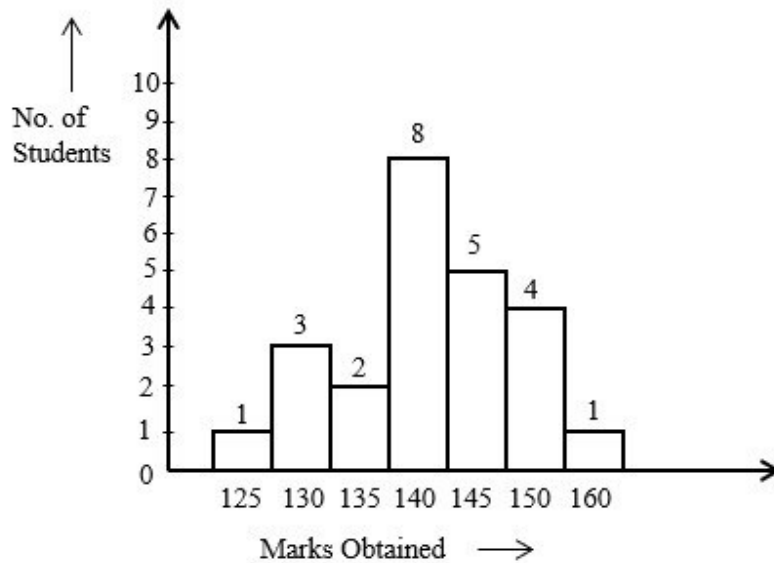

How many students obtained more than the average marks of the class?

- Ans
- 1. 11
  - 2. 6
  - 3. 10
  - 4. 8

Section : General Awareness

1. The Citizenship Act, 1955 does NOT deal with \_\_\_\_\_.

- Ans
- 1. termination
  - 2. election
  - 3. determination
  - 4. acquisition

2. Which of the following animals can change their gender during their life span?

- Ans
- 1. Ascaris
  - 2. Humans
  - 3. nereis
  - 4. Snail

3. Match the following renewable sources of energy with their producing regions in India correctly.

Renewable source of energy	Regions in India
1. Tidal energy	a. Gulf of Khambhat
2. Wind energy	b. Nagercoil
3. Geo Thermal energy	c. Puga valley

- Ans
- 1. 1-b, 2-c, 3-a
  - 2. 1-a, 2-b, 3-c
  - 3. 1-b, 2-a, 3-c
  - 4. 1-c, 2-b, 3-a

Q.4 Khubakeshei is a kind of song accompanied by clapping, sung in the state of \_\_\_\_\_.

- Ans
- 1. Manipur
  - 2. Bihar
  - 3. Karnataka
  - 4. Odisha

Q.5 Which of the following methods measures poverty on the basis of income and consumption levels?

- Ans
- 1. Poverty limit
  - 2. Poverty line
  - 3. Poverty bar
  - 4. Poverty band

Q.6 The Lushai Hills are also known as \_\_\_\_\_.

- Ans
- 1. Mizo Hills
  - 2. Khasi Hills
  - 3. Patkai Hills
  - 4. Naga Hills

Q.7 Where is Birsamunda International Hockey Stadium located?

- Ans
- 1. Bhubaneswar
  - 2. Jamshedpur
  - 3. Ranchi
  - 4. Rourkela

Q.8 To enhance the interoperability between the Indian and Russian Armies, a joint training exercise called \_\_\_\_\_ commenced at Prudboy Ranges, Volgograd in the year 2021.

- Ans
- 1. SHAKTI 2021
  - 2. INDRA 2021
  - 3. SURYA KIRAN 2021
  - 4. VARUNA 2021

Q.9 Which of the following is NOT one of the consequences of the Green Revolution?

- Ans
- 1. Rising prices and a shift in the mode of payment of agricultural workers from payment in cash to payment in kind (grain)
  - 2. The rich grew richer and many of the poor stagnated or grew poorer
  - 3. Wages of agricultural workers increased
  - 4. Employment of agricultural workers increased

Q.10 Which of the following is the maximum file size that can be attached to an email message in Gmail?

- Ans
- 1. 100 MB
  - 2. 200 MB
  - 3. 50 MB
  - 4. 25 MB

Q.11 The famous folk music 'Hekialeu' has its origin in which state?

- Ans
- 1. Tami Nadu
  - 2. Nagaland
  - 3. Goa
  - 4. Assam



Q.12 The British Government passed a law in the year 1856. It was meant for which among the following social reforms?

- Ans
- 1. Abolition of the Practice of Sati
  - 2. Widow Remarriage
  - 3. Abolition of Practice of Child Marriage
  - 4. Law against Murdering of Female Child

Q.13 A circular coil having 'n' turns produces a field \_\_\_\_\_ times large as that produced by a single turn

- Ans
- 1. 2n
  - 2. n
  - 3. 4n
  - 4. 3n

Q.14 Which of the following statements is INCORRECT regarding the Coriolis force?

- Ans
- 1. It is absent at the equator.
  - 2. Deflection is less when the wind is high.
  - 3. It deflects the wind to the right in the north and left in the south.
  - 4. It is directly proportional to the angle of altitude

Q.15 Which of the following state is the best governed state in the large states category as per the Public Affairs Index, 2020, which was released by the Public Affairs Centre, a non-profit organisation?

- Ans
- 1. Odisha
  - 2. Bihar
  - 3. Kerala
  - 4. Uttar Pradesh

Q.16 In April 2023, Wing Commander Deepika Misra received which of the following awards?

- Ans
- 1. Vayu Sena Medal
  - 2. Uttam Yudh Seva Medal
  - 3. Vir Chakra
  - 4. Shaurya Chakra

Q.17 Gugga is the famous ritualistic dance of \_\_\_\_\_, which is performed in the procession taken out in memory of Gugga Pir.

- Ans
- 1. Puducherry
  - 2. Uttar Pradesh
  - 3. Haryana
  - 4. Jammu & Kashmir

Q.18 What takes place when you click the Save button or press Ctrl + S in Microsoft Word?

- Ans
- 1. The document is copied to the clipboard.
  - 2. The document is printed.
  - 3. The document is closed.
  - 4. The document is saved in a disk file.

Q.19 What is the colour of the sending off card in football?

- Ans
- 1. Black
  - 2. Red
  - 3. Blue
  - 4. Yellow

Q.20 Maldives are located to the south of which island of India?

- Ans
- 1. Andaman and Nicobar
  - 2. Lakshadweep
  - 3. Japan
  - 4. Sri Lanka

Q.21 Muharram is the \_\_\_\_\_ month of the Islamic Calendar and is considered a holy month.

- Ans
- 1. fourth
  - 2. second
  - 3. third
  - 4. first

Q.22 Fighting in the upright position in judo is called \_\_\_\_\_.

- Ans
- 1. tachi-waza
  - 2. ne-waza
  - 3. ashi-waza
  - 4. koshi-waza

Q.23 At which place was the magnificent temple of Saiva constructed by the great Rashtrakuta King 'Krishna I'?

- Ans
- 1. Kanchi
  - 2. Badami
  - 3. Kannauj
  - 4. Ellora

Q.24 Which of the following Articles of the Constitution states that 'It shall be the duty of every citizen of India to promote harmony and the spirit of common brotherhood amongst all the people of India transcending religious, linguistic and regional or sectional diversities; to renounce practices derogatory to the dignity of women.'?

- Ans
- 1. 51 A (b)
  - 2. 51 A (d)
  - 3. 51 A (e)
  - 4. 51 A (c)

Q.25 Which of the following is the correct formula for calculating NNP?

- Ans
- 1.  $NNP = GNP - DEPRECIATION$
  - 2.  $NNP = GNP + DEPRECIATION$
  - 3.  $NNP = GDP - INCOME$
  - 4.  $NNP = GDP - DEPRECIATION$

## Combined Higher Secondary Level Examination 2024 Tier I

Exam Date	02/07/2024
Exam Time	5:15 PM - 6:15 PM
Subject	CHSL Exam 2024 Tier I

### Section : English Language

1. Identify the grammatical error in the following sentence and select the correct tense from the options given below.

I have met my friend yesterday.

- Ans
- 1. had been meeting
  - 2. was meeting
  - 3. met my friend
  - 4. have been meeting

Q.2 The following sentence has been split into four segments. Identify the segment that contains a grammatical error.

The teacher was / taken back by / the audacity of / the new student.

A B C D

- Ans
- 1. D
  - 2. C
  - 3. A
  - 4. B

3. Select the most appropriate article to fill in the blank.  
\_\_\_\_\_ bed you sleep in is broken.

- Ans
- 1. A
  - 2. On
  - 3. The
  - 4. An

Q.4 Select the option that will improve the given sentence by using the most appropriate verb.  
That Macbook belong to Xavier.

- Ans
- 1. That Macbook is belonged to Xavier.
  - 2. That Macbook belongs to Xavier.
  - 3. That Macbook belonging to Xavier.
  - 4. That Macbook is belong to Xavier.

**Comprehension:**

In the following passage, some words have been deleted. Read the passage carefully and select the most appropriate option to fill in each blank.

It is generally (1) \_\_\_\_\_ that the methodology of teaching-learning is the concern of teachers only. Learners have (2) \_\_\_\_\_ or nothing to do with it. But this is not true. The teaching-learning (3) \_\_\_\_\_ are concerns of learners as well. Knowing and understanding that how different subjects are taught are important for the learners of all subjects, but it has more (4) \_\_\_\_\_ for the learners of physical education. When we talk about you as learners of physical education, we mean that you have actually participated in the subject area, rather than (5) \_\_\_\_\_ studied it.

**SubQuestion No : 5****Q.5 Select the most appropriate option to fill in blank no. 1.**

- Ans**
- 1. hoped
  - 2. wished
  - 3. planned
  - 4. believed

**Comprehension:**

In the following passage, some words have been deleted. Read the passage carefully and select the most appropriate option to fill in each blank.

It is generally (1) \_\_\_\_\_ that the methodology of teaching-learning is the concern of teachers only. Learners have (2) \_\_\_\_\_ or nothing to do with it. But this is not true. The teaching-learning (3) \_\_\_\_\_ are concerns of learners as well. Knowing and understanding that how different subjects are taught are important for the learners of all subjects, but it has more (4) \_\_\_\_\_ for the learners of physical education. When we talk about you as learners of physical education, we mean that you have actually participated in the subject area, rather than (5) \_\_\_\_\_ studied it.

**SubQuestion No : 6****Q.6 Select the most appropriate option to fill in blank no. 2.**

- Ans**
- 1. light
  - 2. minute
  - 3. little
  - 4. sparse

**Comprehension:**

In the following passage, some words have been deleted. Read the passage carefully and select the most appropriate option to fill in each blank.

It is generally (1) \_\_\_\_\_ that the methodology of teaching-learning is the concern of teachers only. Learners have (2) \_\_\_\_\_ or nothing to do with it. But this is not true. The teaching-learning (3) \_\_\_\_\_ are concerns of learners as well. Knowing and understanding that how different subjects are taught are important for the learners of all subjects, but it has more (4) \_\_\_\_\_ for the learners of physical education. When we talk about you as learners of physical education, we mean that you have actually participated in the subject area, rather than (5) \_\_\_\_\_ studied it.

**SubQuestion No : 7****Q.7 Select the most appropriate option to fill in blank no. 3.**

- Ans**
- 1. forms
  - 2. breaks
  - 3. customs
  - 4. methods

**Comprehension:**

In the following passage, some words have been deleted. Read the passage carefully and select the most appropriate option to fill in each blank.

It is generally (1) \_\_\_\_\_ that the methodology of teaching-learning is the concern of teachers only. Learners have (2) \_\_\_\_\_ or nothing to do with it. But this is not true. The teaching-learning (3) \_\_\_\_\_ are concerns of learners as well. Knowing and understanding that how different subjects are taught are important for the learners of all subjects, but it has more (4) \_\_\_\_\_ for the learners of physical education. When we talk about you as learners of physical education, we mean that you have actually participated in the subject area, rather than (5) \_\_\_\_\_ studied it.

**SubQuestion No : 8****Q.8 Select the most appropriate option to fill in blank no. 4.**

- Ans**
- 1. reference
  - 2. recurrence
  - 3. relevance
  - 4. consistency

**Comprehension:**

In the following passage, some words have been deleted. Read the passage carefully and select the most appropriate option to fill in each blank.

It is generally (1) \_\_\_\_\_ that the methodology of teaching-learning is the concern of teachers only. Learners have (2) \_\_\_\_\_ or nothing to do with it. But this is not true. The teaching-learning (3) \_\_\_\_\_ are concerns of learners as well. Knowing and understanding that how different subjects are taught are important for the learners of all subjects, but it has more (4) \_\_\_\_\_ for the learners of physical education. When we talk about you as learners of physical education, we mean that you have actually participated in the subject area, rather than (5) \_\_\_\_\_ studied it.

**SubQuestion No : 9**

**Q.9** Select the most appropriate option to fill in blank no. 5.

- Ans
- 1. merely
  - 2. hardly
  - 3. purely
  - 4. entirely

**Q.10** Select the most appropriate meaning of the given idiom.  
On its last legs

- Ans
- 1. Creeping on legs
  - 2. Last choice
  - 3. Slow movement
  - 4. In a bad condition

**Q.11** Select the most appropriate ANTONYM of the underlined word in the following sentence.  
The upshot of the consultation with the doctor was an operation scheduled for the next week.

- Ans
- 1. Blame
  - 2. Cause
  - 3. Result
  - 4. Estimate

**Q.12** Select the most appropriate idiomatic expression that can substitute the underlined segment in the given sentence.:  
It feels like I made a promise of more than my ability when I promised to complete this worksheet in one day.

- Ans
- 1. beat my brain out
  - 2. beat the drum
  - 3. bit off more than I could chew
  - 4. burnt a hole in my pocket

**Q.13** Select the most appropriate option that can substitute the underlined segment in the given sentence.  
It will take two hours to walk across the forest.

- Ans
- 1. through
  - 2. over
  - 3. away
  - 4. between

**Q.14** Select the most appropriate option that can substitute the underlined segment in the given sentence.  
The wizard, while performing an item, accidentally set his own hat on fire and prompted the fire alarm to go on.

- Ans
- 1. the fire alarm to go away
  - 2. the fire alarm to go under
  - 3. the fire alarm to go off
  - 4. the fire alarm to go above

Q.15 Identify the incorrectly spelt word and select its correct spelling.  
Maybe he wanted to make sure he didn't embarrass her.

- Ans
- 1. sware
  - 2. shure
  - 3. embarrass
  - 4. emberess

Q.16 Select the most appropriate ANTONYM of the underlined word in the given sentence.  
The plot of the novel is very dull.

- Ans
- 1. Diverting
  - 2. Riveting
  - 3. Plodding
  - 4. Charming

Q.17 Select the most appropriate option that collocates with 'wish' to fill in the blank.  
The genie asked Aladdin to \_\_\_\_\_ a wish.

- Ans
- 1. make
  - 2. take
  - 3. ask
  - 4. tell

Q.18 Select the most appropriate synonym of the given word.  
Remission

- Ans
- 1. Pardon
  - 2. Retribution
  - 3. Punishment
  - 4. Overlook

Q.19 Read the sentence carefully and select the most appropriate option to substitute the underlined part.

You can be sentenced for trespassing on someone else's property.

- Ans
- 1. conspiring against others
  - 2. entering without permission
  - 3. leaving without permission
  - 4. showing unselfish devotion

Q.20 Select the most appropriate synonym of the underlined word.

Let us assume that we will do the job honestly.

- Ans
- 1. allow
  - 2. think
  - 3. take
  - 4. give

Q.21 Select the most appropriate option to fill in the blank.

She could easily eat the \_\_\_\_\_ biryani by herself.

- Ans
- 1. whole
  - 2. haul
  - 3. hall
  - 4. hole

Q.22 Select the option that rectifies the spelling of the underlined word in the given sentence.  
It has been a usual ocurrence for a few days now.

- Ans
- 1. occerrence
  - 2. occurrence
  - 3. occurence
  - 4. occurrence

Q.23 Select the most appropriate option that can substitute the underlined segment in the given sentence. If there is no need to substitute it, select 'No improvement required'.  
We set up on the journey early in the morning.

- Ans
- 1. set off
  - 2. set in
  - 3. No improvement required
  - 4. set about

Q.24 Select the most appropriate ANTONYM of the word given in the bracket to fill in the blank.

The State media houses present \_\_\_\_\_(vociferous) views compared to private media.

- Ans
- 1. political
  - 2. biased
  - 3. mild
  - 4. assertive

Q.25 Select the most appropriate ANTONYM of the underlined word in the given sentence.  
Few people turned up to attend the tawdry promo of the new movie.

- Ans
- 1. Elegant
  - 2. Showy
  - 3. Inferior
  - 4. Gawdy

Section : General Intelligence

Q.1 What should come in place of ? in the given series based on the English alphabetical order?

SLE CXS ? WVU GHI

- Ans
- 1. COR
  - 2. HAP
  - 3. OWG
  - 4. MIJ

Q.2 Select the correct mirror image of the given figure when the mirror is placed at MN.

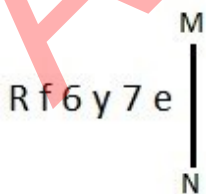

- Ans
- 1. e7y6fR
  - 2. e7y6fR
  - 3. Rf6y7e
  - 4. Rf6y7e

3. Three of the following four are alike in a certain way and thus form a group. Which is the one that does NOT belong to that group?  
(Note: The odd one out is not based on the number of consonants/vowels or their position in the letter cluster.)

Ans  1. MPR  
 2. TWY  
 3. BEG  
 4. JMN

- Q.4 Select the letter-cluster pair that best represents a similar relationship to the one expressed in the pairs of letter-clusters given below.  
GKI : MQO  
CGE : IMK

Ans  1. HLJ: NRO  
 2. LPN: RVT  
 3. RUT: VZX  
 4. JOM: PUR

- Q.5 Select the correct mirror image of the given combination when the mirror is placed at MN as shown below.

M  
|  
5 @ h R p 7  
|  
N

Ans  1. 7 q R h @ 5  
 2. 7 q R h @ 5  
 3. 7 q R h @ 5  
 4. 5 @ h R p 7

- Q.6 9 is related to 47 following a certain logic. Following the same logic, 12 is related to 62. To which of the following is 17 related, following the same logic?

(NOTE: Operations should be performed on the whole numbers, without breaking down the numbers into their constituent digits. E.g. 13 – Operations on 13 such as adding/ subtracting /multiplying to 13 can be performed. Breaking down 13 into 1 and 3 and then performing mathematical operations on 1 and 3 is not allowed.)

Ans  1. 97  
 2. 87  
 3. 85  
 4. 75

- Q.7 Select the word-pair that best represents a similar relationship to the one expressed in the pair of words given below.

(The words must be considered as meaningful English words and must not be related to each other based on the number of letters/number of consonants/vowels in the word)

Happy : Ecstatic

Ans  1. Loyal : Betray  
 2. Honest : Deceptive  
 3. Polite : Courteous  
 4. Progress : Stagnation



Q.8 What should come in place of the question mark (?) in the given series?

3, 10, 24, ?, 73, 108, 150, 199

Ans  1. 40

2. 30

3. 35

4. 45

Q.9 'A + B' means 'A is the brother of B'.

'A - B' means 'A is the sister of B'.

'A × B' means 'A is the father of B'.

'A ÷ B' means 'A is the mother of B'.

Using the same meaning of the mathematical operators as given above, which of the following shows 'P is the father's father of S'?

Ans  1.  $P - Q + R ÷ S$

2.  $P × Q × R + S$

3.  $P + Q - R ÷ S$

4.  $P + Q + R × S$

Q.10 If 'A' stands for '+', 'B' stands for '×', 'C' stands for '÷' and 'D' stands for '-', what will come in place of the question mark (?) in the following equation?

95 B 8 D 12 A 2 C 16 = ?

Ans  1. 710

2. 750

3. 730

4. 770

Q.11 Each of the letters in the word FRAMED is arranged in alphabetical order. How many letters are there in the English alphabetical series between the letter which is second from the left and the one which is second from the right in the new letter cluster thus formed?

Ans  1. Nine

2. Eight

3. Six

4. Seven

Q.12 If 'A' stands for '+', 'B' stands for '×', 'C' stands for '÷' and 'D' stands for '-', what will come in place of the question mark (?) in the following equation?

11 B 11 D 68 A 4 C 4 = ?

Ans  1. 106

2. 102

3. 108

4. 104

Q.13 A square sheet of paper is folded along the dotted line successively along the directions shown and is then punched in the last. How would the paper look when unfolded?

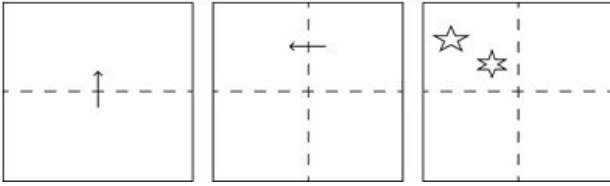

Ans

1.

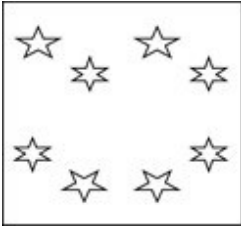

2.

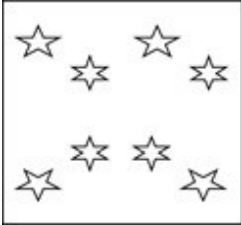

3.

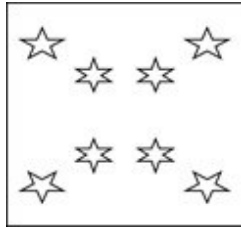

4.

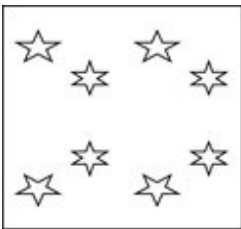

Q.14 In a certain code language, 'BROW' is coded as '7542' and 'WORM' is coded as '7295'. What is the code for 'B' in the given code language?

- Ans
- 1. 2
  - 2. 9
  - 3. 4
  - 4. 7

Q.15 How many triangles are there in the following figure?

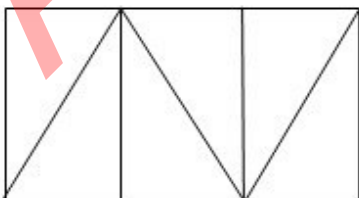

- Ans
- 1. 6
  - 2. 5
  - 3. 7
  - 4. 8

Q.16 What will come in the place of '?' in the following equation if '+' and 'x' are interchanged and '-' and '÷' are interchanged?  
 $90 - 10 \times 36 + 52 \div 49 = ?$

- Ans
- 1. 654
  - 2. 1832
  - 3. 879
  - 4. 567

Q.17 Each of the letters in the word JUSTICE are arranged in alphabetical order. How many letters are there in the English alphabetical series between the letter that is second from the left and the one that is fourth from the right in the new letter cluster thus formed ?

- Ans
- 1. 6
  - 2. 4
  - 3. 7
  - 4. 5

Q.18 Which of the following numbers will replace the question mark (?) in the given series?  
12 60 20 100 60 300 260 ?

- Ans
- 1. 1300
  - 2. 1160
  - 3. 1240
  - 4. 1280

Q.19 What should come in place of the question mark (?) in the given series based on the English alphabetical order?  
ECF, JHK, OMP, TRU, ?

- Ans
- 1. YWZ
  - 2. XVZ
  - 3. XYZ
  - 4. YVZ

Q.20 Three statements are followed by conclusions numbered I, II. You have to consider these statements to be true, even if they seem to be at variance with commonly known facts. Decide which of the given conclusions logically follow/s from the given statement.

Statements:

All fire is water.

Some water is earth.

No earth is air.

Conclusion (I): Some fire is earth.

Conclusion (II): Some fire is air.

- Ans
- 1. Neither conclusion (I) nor (II) follows.
  - 2. Only conclusion (II) follows.
  - 3. Both conclusions (I) and (II) follow.
  - 4. Only conclusion (I) follows.

Q.21 Select the correct mirror image of the given combination when the mirror is placed at MN as shown below.



Ans

1. Meqk73L

2. p37kMed

3. 73kMeq

4. 73kMed

Adda247 Marathi

Q.22 Select the option in which the given figure X is embedded (rotation is NOT allowed).

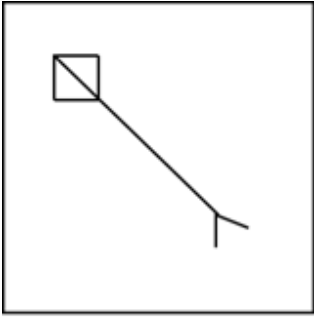

(X)

Ans

✓ 1.

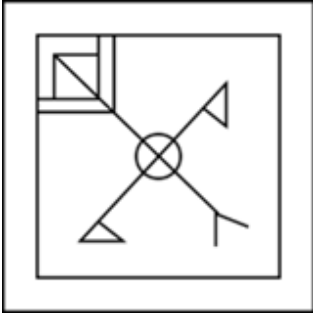

✗ 2.

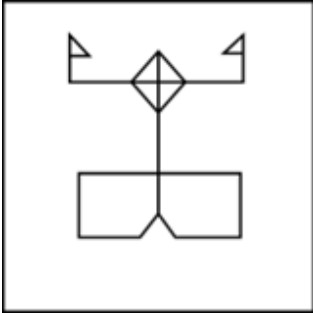

✗ 3.

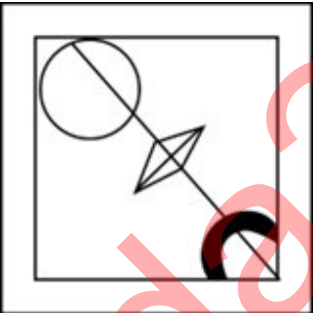

✗ 4.

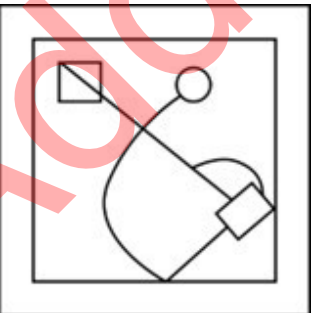

Q.23 Which figure should replace the question mark (?) if the following figure series were to be continued?

V	4	△	X	
X	B	V	B	?
B	4 X	V B	X V	△

Ans

✓ 1.

C	
	△
B	V

✗ 2.

C	
	V
△	B

✗ 3.

V	
	△
X	B

✗ 4.

X	
	△
B	V

Q.24 In a certain code language, 'SORT' is coded as '4698' and 'RUST' is coded as '6429'. How is 'O' coded in the given language?

- Ans
- ✗ 1. 6
  - ✗ 2. 9
  - ✗ 3. 4
  - ✓ 4. 8

Q.25 Select the set in which the numbers are related in the same way as are the numbers of the following sets.  
 (NOTE: Operations should be performed on the whole numbers, without breaking down the numbers into its constituent digits. E.g. 13 – Operations on 13 such as adding/subtracting/multiplying etc. to 13 can be performed. Breaking down 13 into 1 and 3 and then performing mathematical operations on 1 and 3 is not allowed.)  
 (18, 7, 119)  
 (11, 9, 90)

- Ans
- ✗ 1. (13, 5, 58)
  - ✗ 2. (16, 5, 65)
  - ✓ 3. (12, 4, 44)
  - ✗ 4. (17, 6, 102)

Q.1

If  $\sqrt{13} \sin \theta = 2$ , then the value of  $\frac{3 \tan \theta + \sqrt{13} \sin \theta}{\sqrt{13} \cos \theta - 3 \tan \theta}$  is:

- Ans
- 1. 4
  - 2. 3
  - 3. 2
  - 4. 0

Q.2 In  $\triangle ABC$  the straight line parallel to the side BC meets AB and AC at the points P and Q, respectively. If AP = QC, the length of AB is 12 cm and the length of AQ is 2 cm, then the length (in cm) of CQ is:

- Ans
- 1. 6
  - 2. 4
  - 3. 3
  - 4. 2

Q.3 Simplify the following:

$$\frac{3}{2} \times \frac{11}{5} \div \left( \frac{25}{44} \times \frac{11}{5} \right) \div \frac{33}{15} = ?$$

- Ans
- 1.  $\frac{6}{5}$
  - 2.  $\frac{1}{2}$
  - 3.  $\frac{2}{3}$
  - 4.  $\frac{5}{6}$

Q.4 At the beginning of day 1 of a month, Rajesh has 500 eggs. He sells 20% of the eggs by the end of the day and added b% of the eggs at the beginning of the next day and sold 20% of the eggs at the end of the next day. This pattern continued up to the end of the third day of the month when he is left with 1024 eggs. The value of b is equal to:

- Ans
- 1. 20
  - 2. 10
  - 3. 500
  - 4. 100

Q.5 The outer surface of a sphere having diameter 10 m is painted at the rate of ₹  $\frac{80}{\pi}$  per  $m^2$ . What is the cost of painting?

- Ans
- 1. ₹4,000
  - 2. ₹6,000
  - 3. ₹8,000
  - 4. ₹9,000

Q.6

The given pie-charts show the distribution of Graduate and Post-Graduate level students in five different colleges A, B, C, D and E.

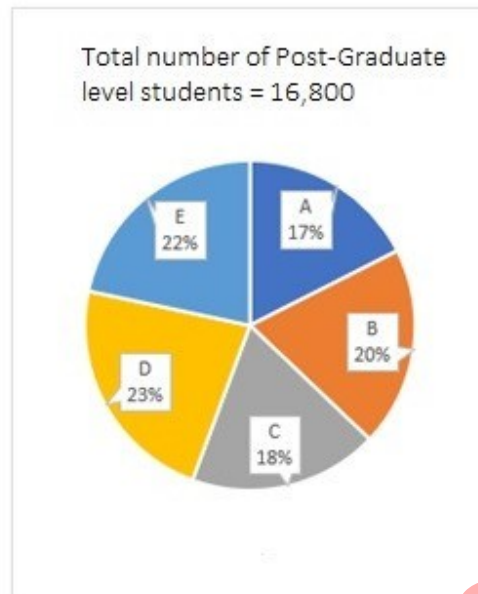
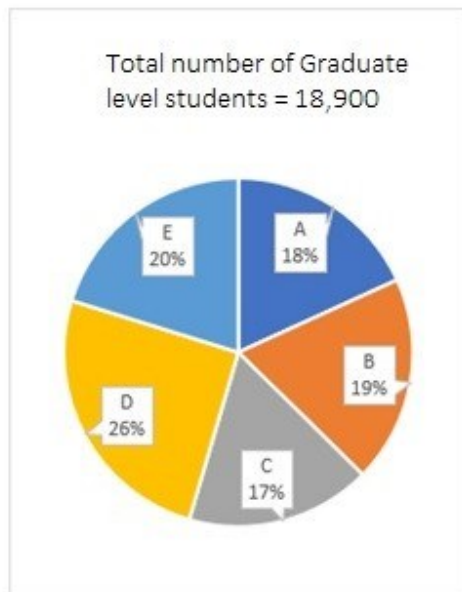

How many students of colleges A and B are studying at Graduate level?

- Ans
- 1. 5,987
  - 2. 4,520
  - 3. 6,993
  - 4. 7,052

Q.7 L and M are the mid points of sides AB and AC of a triangle ABC, respectively, and BC = 18 cm. If LM || BC, then find the length of LM (in cm).

- Ans
- 1. 6
  - 2. 3
  - 3. 9
  - 4. 12



Q.8

Study the given bar-graph and answer the question that follows.

The bar-graph shows the production (in lakh) of kitchen appliances manufactured by three companies A, B, and C over a period of six years from 2012 to 2017.

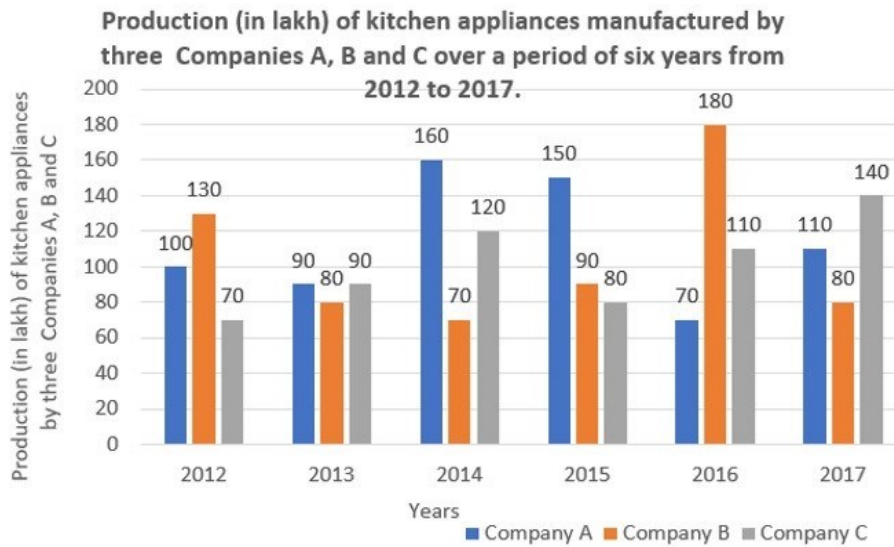

80% of the combined average production of companies B and C is what percentage (to the nearest integer) more/less than 90% of the average production of company A, for the given period of 2012 to 2017?

- Ans
- 1. 21% more
  - 2. 21% less
  - 3. 19% less
  - 4. 19% more

Q.9 In an election between two candidates, one got 65% of the total valid votes. 20% of the votes were invalid. If the total number of votes was 7,500, the number of valid votes that the other candidate got was:

- Ans
- 1. 1,700
  - 2. 2,100
  - 3. 4,300
  - 4. 1,900

Q.10 In  $\triangle PQR$ ,  $PR = 10$  cm. Find the length of  $PT$ , where  $ST \parallel QR$ . Given that  $PS = 6$  cm and  $QS = 14$  cm.

- Ans
- 1. 2 cm
  - 2. 4 cm
  - 3. 1.5 cm
  - 4. 3 cm

Q.11 The radius and height of a cylinder are in the ratio 6 : 7 and its volume is  $792 \text{ cm}^3$ . Calculate its curved surface area in  $\text{cm}^2$ .

- Ans
- 1. 490
  - 2. 226
  - 3. 264
  - 4. 262

Q.12 Two trains of lengths 310 m and 330 m, respectively, are 160 m apart. They start moving towards each other on parallel tracks, at speeds 130 km/h and 158 km/h, respectively. In how much time (in seconds) will the trains cross each other?

- Ans
- 1. 10
  - 2. 8
  - 3. 12
  - 4. 18

Q.13 A sum becomes ₹6,600 in 4 years at simple interest at a yearly interest rate of 5% per annum. What is the sum?

- Ans
- 1. ₹4,400
  - 2. ₹3,300
  - 3. ₹5,500
  - 4. ₹6,000

Q.14 Divide some money in the ratio Ravi, Reeta and Rahul that 5 (Part of Ravi) = 3 (Part of Reeta) = 11 (Part of Rahul). The money ratio of Ravi : Reeta : Rahul is equal to:

- Ans
- 1. 5 : 11 : 3
  - 2. 33 : 55 : 15
  - 3. 11 : 33 : 15
  - 4. 11 : 5 : 3

Q.15 What is the number of digits required for numbering a book with 428 pages?

- Ans
- 1. 1176
  - 2. 1500
  - 3. 2000
  - 4. 988

Q.16 In June, Rohit's bank account balance is ₹5,000 for 25 days, ₹20,000 for 2 days and ₹1,500 for 3 days. What is the average balance (in ₹) in Rohit's bank account in June?

- Ans
- 1. 5575
  - 2. 5650
  - 3. 5200
  - 4. 6000

Q.17 Two offers were being made to Swaroop for a watch with a marked price of ₹1,600. Either two successive discounts of 20%, or two discounts of 30% and 10% after each other is offered. If Swaroop opted for the better plan over the other, how much more must he have saved?

- Ans
- 1. ₹35
  - 2. ₹30
  - 3. ₹16
  - 4. ₹22

Q.18 A man spends 35% of his monthly income on food and four-thirteenths of the remaining income on transport. He incurs some other expenses, but also saves Rs.6,300 per month, the latter being equal to 20% of the balance remaining just after spending on food and transport. What is his monthly income (in Rs.)?

- Ans
- 1. 67500
  - 2. 72,000
  - 3. 70,000
  - 4. 63000

Q.19 A, B and C can complete a work in 12, 15 and 20 days, respectively. How many days are required to finish the work if they work together?

- Ans
- 1. 5 days
  - 2. 3 days
  - 3. 6 days
  - 4. 4 days

Q.20 In  $\triangle EFG$ ,  $XY \parallel FG$ , area of the quadrilateral  $XFGY = 44 \text{ m}^2$ . If  $EX : XF = 2 : 3$ , then find the area of  $\triangle EXY$  (in  $\text{m}^2$ ).

- Ans
- 1. 8.38
  - 2. 9.46
  - 3. 7.28
  - 4. 8.10

Q.21 If the point of intersection of lines  $x + y = 2$  and  $2x - y = 1$  lies on  $y = Kx + 5$ , what is the value of  $K$ ?

- Ans
- 1. 3
  - 2. -4
  - 3. 4
  - 4. -3

Q.22 The difference between the cost price and the selling price of an article is ₹1,800. If there is a profit of 20%, then the cost price of the article is:

- Ans
- 1. ₹9,000
  - 2. ₹11,000
  - 3. ₹8,000
  - 4. ₹7,000

Q.23 The triangle has sides 3 cm, 4 cm and 5 cm. What is the length of the perpendicular from the opposite vertex to the side whose length is 5 cm?

- Ans
- 1. 2.4 cm
  - 2. 3.5 cm
  - 3. 1.4 cm
  - 4. 2.2 cm

Q.24 Study the given table and answer the question that follows.

The table shows the number of students appeared and qualified (in thousands) district-wise in the EMCET examination in a state.

Year	A	B	C	D	E	F
	App/Qual	App/Qual	App/Qual	App/Qual	App/Qual	App/Qual
2014	40/21	50/35	60/29	50/37	45/22	48/32
2015	50/26	60/38	60/42	40/26	35/22	45/19
2016	55/42	35/22	48/26	50/30	55/27	60/19

The total percentage of students who qualified in the year 2016 (correct up to two decimals) is:

- Ans
- ✓ 1. 54.78%
  - ✗ 2. 44.72%
  - ✗ 3. 52.82%
  - ✗ 4. 55.18%

Q.25 The given line graph shows the number of scooters manufactured (in thousands) by companies X and Z, over the years.

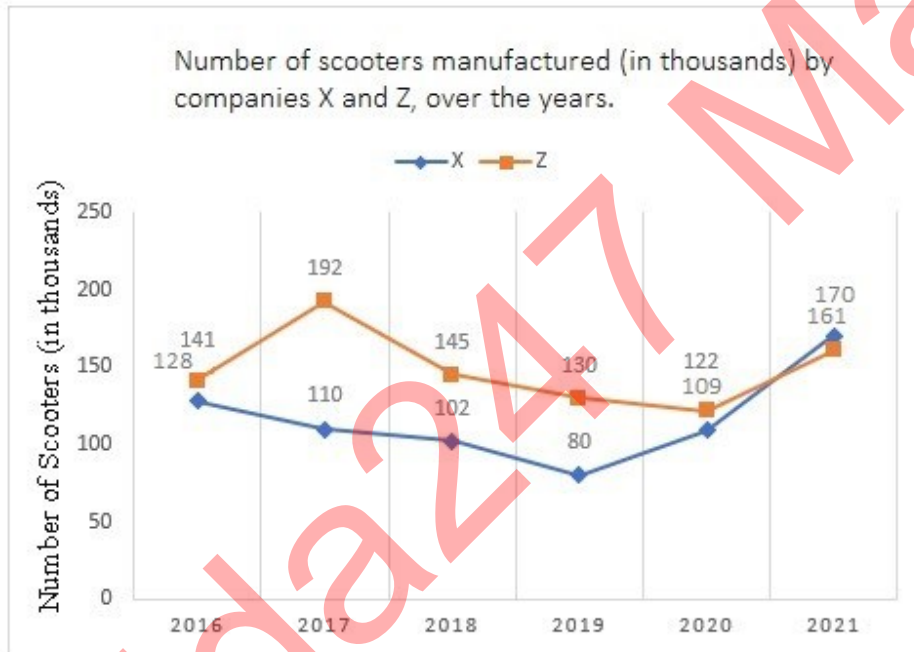

What is the average number of scooters manufactured by company X over the given period?

- Ans
- ✗ 1. 126500
  - ✗ 2. 213000
  - ✗ 3. 256000
  - ✓ 4. 116500

Section : General Awareness

1. Which of the following musical forms in Carnatic Classical is the simplest composition of raga?

- Ans
- ✗ 1. Arnam
  - ✗ 2. Pada
  - ✓ 3. Gitam
  - ✗ 4. Kirtnam

2. How can you insert a blank row at the top of a worksheet?

Ans 1.  Right-click on the row number and select Insert.

2. Drag the mouse on the row border to select the row and click Insert in the Cells group on the Home tab.

3. Click on the row number and press the Insert key on the keyboard.

4. Click on the row number and press the Delete key on the keyboard.

3. In Microsoft PowerPoint, what is the shortcut key combination to insert a new slide in a presentation?

Ans 1.  Ctrl + N

2. Ctrl + D

3. Ctrl + I

4. Ctrl + M

Q.4 Which of the following was a feature of the Indian economy before the British rule?

Ans  1. Prosperous economy

2. Self-reliant economy

3. Dependent economy

4. Independent economy

Q.5 A distinctive cross-shaped constellation best seen in the northern hemisphere during the summer and fall months around September is:

Ans  1. Pegasus

2. Ursa Major

3. Cassiopeia

4. Cygnus

Q.6 Which of the following dynasties' genealogy was found in the Bijolia inscription?

Ans  1. Gahadavala

2. Parmara

3. Chahamana

4. Chandela

Q.7 In Kabaddi, a super tackle is when a raider is caught/self out/declared out with or less than how many defenders defending?

Ans  1. Four

2. Three

3. Six

4. Five

Q.8 Bali Yatra, is a traditional cultural festival of which state?

Ans  1. Odisha

2. Bihar

3. West Bengal

4. Assam

Q.9 In April 2023, India's External Affairs Minister S Jaishankar launched the project for restoration of which of the following ghats?

Ans  1. Manikarnika Ghat

2. Assi Ghat

3. Cheer Ghat

4. Tulsi Ghat

Q.10 In which year did Eric A Cornell, Wolfgang Ketterle and Carl E. Wieman receive the Nobel Prize in Physics for the achieving 'Bose-Einstein condensation in dilute gases of alkali atoms'?

- Ans
- 1. 2002
  - 2. 2000
  - 3. 2001
  - 4. 2003

Q.11 In which judgement did the Supreme Court extend the scope of Article 21 and observed that 'the Right to education flows directly from the Right to life'?

- Ans
- 1. Kharak Singh v State of UP
  - 2. Malak Singh v State of Punjab
  - 3. Mohini Jain v State of Karnataka
  - 4. Neerja Choudhari v State of M. P.

Q.12 When did the first War of Indian Independence (Sepoy Mutiny) start?

- Ans
- 1. 1819
  - 2. 1887
  - 3. 1857
  - 4. 1839

Q.13 In a dihybrid cross between two heterozygous fruit flies with brown bodies and red eyes (BbEe X BbEe), what will be the probability of getting BBEE genotype?

- Ans
- 1. 1/16
  - 2. 1/4
  - 3. 1/8
  - 4. 1/2

Q.14 Which of the following Articles was amended by The Constitution Fiftieth Amendment Act, 1984?

- Ans
- 1. Article 56
  - 2. Article 33
  - 3. Article 78
  - 4. Article 99

Q.15 \_\_\_\_\_ has called the Right to Constitutional Remedy as the 'Soul of the Constitution'.

- Ans
- 1. Dr. BR Ambedkar
  - 2. Lal Lajpat Rai
  - 3. Jawaharlal Nehru
  - 4. Bal Gangadhar Tilak

Q.16 Which type of soil is found on about 40% of the total area of India?

- Ans
- 1. Black soil
  - 2. Red and Yellow soil
  - 3. Laterite soil
  - 4. Alluvial soil

Q.17 \_\_\_\_\_ at Market Price refers to the sum total of factor incomes earned by residents of a country during an accounting year including net indirect taxes.

- Ans
- 1. Net Domestic Product (NDP)
  - 2. Gross Domestic Product (GDP)
  - 3. Gross National Product (GNP)
  - 4. Net National Product (NNP)

Q.18 According to the Census of India 2011, which group of states has the least urban population?

- Ans
- 1. Himachal Pradesh and Meghalaya
  - 2. Himachal Pradesh and Bihar
  - 3. Uttar Pradesh and Bihar
  - 4. Madhya Pradesh and Bihar

Q.19 \_\_\_\_\_ was an Indian dancer and choreographer best known for creating a fusion style of dance adapting European theatrical techniques to Indian classical and folk-dance forms.

- Ans
- 1. Smita Nagdev
  - 2. Ravi Shankar
  - 3. Shovana Narayan
  - 4. Uday Shankar

Q.20 Who among the following wrote the popular Telugu patriotic song 'Desamunu preminchumanna, manchi annadi penchumanna' meaning 'Love the nation, grow the goodness'?

- Ans
- 1. Goparaju Ramachandra Rao
  - 2. Gurajada Apparao
  - 3. Sri Krishnadevaraya
  - 4. Bammara Potana

Q.21 Lakshmbai National Institute of Physical Education (LNPE) is located at \_\_\_\_\_.

- Ans
- 1. Madhya Pradesh
  - 2. Haryana
  - 3. Punjab
  - 4. Uttar Pradesh

Q.22 Which of the following districts of India has the highest literacy rate as per Census

- 2011? Ans
- 1. Champhai
  - 2. Serchhip
  - 3. Idukki
  - 4. Ernakulam

Q.23 How many countries participated in the first Asian Games held in 1951?

- Ans
- 1. 24
  - 2. 11
  - 3. 16
  - 4. 20

Q.24 The Bist Doab Canal System and Makhu Canal System are associated with which state of India?

- Ans
- 1. Punjab
  - 2. Assam
  - 3. Uttar Pradesh
  - 4. Gujarat

Q.25 On 9 August 2021, the Parliament had passed the Limited Liability Partnership (Amendment) Bill, 2021. It amended the:

- Ans
- 1. Limited Liability Partnership Act, 2012
  - 2. Limited Liability Partnership Act, 2008
  - 3. Limited Liability Partnership Act, 2004
  - 4. Limited Liability Partnership Act, 2016

## Combined Higher Secondary Level Examination 2024 Tier I

Exam Date	03/07/2024
Exam Time	9:00 AM - 10:00 AM
Subject	CHSL Exam 2024 Tier I

### Section : English Language

1. The following sentence has been divided into parts. One of them may contain an error. Select the part that contains the error from the given options. If you don't find any error, mark 'No error' as your answer.  
Ramya is working / hardly / to get good marks.

Ans  1. hardly  
 2. Ramya is working  
 3. No error  
 4. to get good marks

2. Identify the error in the given sentence and select the correct sentence from the given options.  
Petrified wood is type of fossilised wood that exhibits the original details of the wood.

Ans  1. Petrified wood is the type of fossilised wood that exhibits a original details of the wood.  
 2. A petrified wood is type of fossilised wood that exhibits an original details of the wood.  
 3. The petrified wood is the type of fossilised wood that exhibits a original details of the wood.  
 4. Petrified wood is a type of fossilised wood that exhibits the original details of the wood.

3. Parts of the following sentence have been given as options. Select the option that contains an error. His mother's transfer from a small town to Delhi brought up a huge change in his schooling.

Ans  1. from a small town to Delhi  
 2. His mother's transfer  
 3. in his schooling.  
 4. brought up a huge change

- Q.4 The following sentence has been divided into parts. One of them may contain an error. Select the part that contains the error from the given options. If you don't find any error, mark 'No error' as your answer.

Mrs. Meera and family / received his letter / a week ago.

Ans  1. No error  
 2. Mrs. Meera and family  
 3. received his letter  
 4. a week ago



**Comprehension:**

In the following passage, some words have been deleted. Read the passage carefully and select the most appropriate option to fill in each blank.

On the afternoon of 30 March 1981, many Americans experienced a (i) \_\_\_\_\_ of déjà-vu. Déjà-vu is a name given to the feeling that a person has seen or experienced an event before. Many Americans could not help having that feeling on this day. The (ii) \_\_\_\_\_ hit TVs and radios immediately. President Ronald Reagan had been shot. He was leaving a hotel in Washington DC, turned to wave at some of the people gathered to see him, and fell towards the ground. Before he could hit the ground, his Secret Service Agents (iii) \_\_\_\_\_ him into the car and rushed to the nearest hospital. This same story had been heard before. On 22 November 1963 President John F Kennedy was riding in a motorcade through Dallas, Texas. He smiled and waved to the crowd that had gathered to see him. (iv) \_\_\_\_\_ rang out from a nearby building. The President collapsed into the backseat of the car and was immediately taken to the nearest hospital. He was (v) \_\_\_\_\_ dead at the hospital. Now, just seventeen years later, the news sounded eerily the same.

**SubQuestion No : 5**

**Q.5** Select the most appropriate option to fill in blank No. (i).

- Ans**
- 1. feeling
  - 2. dealing
  - 3. blinking
  - 4. recalling

**Comprehension:**

In the following passage, some words have been deleted. Read the passage carefully and select the most appropriate option to fill in each blank.

On the afternoon of 30 March 1981, many Americans experienced a (i) \_\_\_\_\_ of déjà-vu. Déjà-vu is a name given to the feeling that a person has seen or experienced an event before. Many Americans could not help having that feeling on this day. The (ii) \_\_\_\_\_ hit TVs and radios immediately. President Ronald Reagan had been shot. He was leaving a hotel in Washington DC, turned to wave at some of the people gathered to see him, and fell towards the ground. Before he could hit the ground, his Secret Service Agents (iii) \_\_\_\_\_ him into the car and rushed to the nearest hospital. This same story had been heard before. On 22 November 1963 President John F Kennedy was riding in a motorcade through Dallas, Texas. He smiled and waved to the crowd that had gathered to see him. (iv) \_\_\_\_\_ rang out from a nearby building. The President collapsed into the backseat of the car and was immediately taken to the nearest hospital. He was (v) \_\_\_\_\_ dead at the hospital. Now, just seventeen years later, the news sounded eerily the same.

**SubQuestion No : 6**

**Q.6** Select the most appropriate option to fill in blank No. (ii).

- Ans**
- 1. arrow
  - 2. sceptre
  - 3. news
  - 4. ball

**Comprehension:**

In the following passage, some words have been deleted. Read the passage carefully and select the most appropriate option to fill in each blank.

On the afternoon of 30 March 1981, many Americans experienced a (i) \_\_\_\_\_ of déjà-vu. Déjà-vu is a name given to the feeling that a person has seen or experienced an event before. Many Americans could not help having that feeling on this day. The (ii) \_\_\_\_\_ hit TVs and radios immediately. President Ronald Reagan had been shot. He was leaving a hotel in Washington DC, turned to wave at some of the people gathered to see him, and fell towards the ground. Before he could hit the ground, his Secret Service Agents (iii) \_\_\_\_\_ him into the car and rushed to the nearest hospital. This same story had been heard before. On 22 November 1963 President John F Kennedy was riding in a motorcade through Dallas, Texas. He smiled and waved to the crowd that had gathered to see him. (iv) \_\_\_\_\_ rang out from a nearby building. The President collapsed into the backseat of the car and was immediately taken to the nearest hospital. He was (v) \_\_\_\_\_ dead at the hospital. Now, just seventeen years later, the news sounded eerily the same.

**SubQuestion No : 7**

**Q.7** Select the most appropriate option to fill in blank No. (iii).

- Ans**
- 1. whisked
  - 2. pulled
  - 3. called
  - 4. pushed

**Comprehension:**

In the following passage, some words have been deleted. Read the passage carefully and select the most appropriate option to fill in each blank.

On the afternoon of 30 March 1981, many Americans experienced a (i) \_\_\_\_\_ of déjà-vu. Déjà-vu is a name given to the feeling that a person has seen or experienced an event before. Many Americans could not help having that feeling on this day. The (ii) \_\_\_\_\_ hit TVs and radios immediately. President Ronald Raegan had been shot. He was leaving a hotel in Washington DC, turned to wave at some of the people gathered to see him, and fell towards the ground. Before he could hit the ground, his Secret Service Agents (iii) \_\_\_\_\_ him into the car and rushed to the nearest hospital. This same story had been heard before. On 22 November 1963 President John F Kennedy was riding in a motorcade through Dallas, Texas. He smiled and waved to the crowd that had gathered to see him. (iv) \_\_\_\_\_ rang out from a nearby building. The President collapsed into the backseat of the car and was immediately taken to the nearest hospital. He was (v) \_\_\_\_\_ dead at the hospital. Now, just seventeen years later, the news sounded eerily the same.

**SubQuestion No : 8**

**Q.8** Select the most appropriate option to fill in blank No. (iv).

- Ans**
- 1. Shots
  - 2. Alarm
  - 3. Music
  - 4. Prayers

**Comprehension:**

In the following passage, some words have been deleted. Read the passage carefully and select the most appropriate option to fill in each blank.

On the afternoon of 30 March 1981, many Americans experienced a (i) \_\_\_\_\_ of déjà-vu. Déjà-vu is a name given to the feeling that a person has seen or experienced an event before. Many Americans could not help having that feeling on this day. The (ii) \_\_\_\_\_ hit TVs and radios immediately. President Ronald Raegan had been shot. He was leaving a hotel in Washington DC, turned to wave at some of the people gathered to see him, and fell towards the ground. Before he could hit the ground, his Secret Service Agents (iii) \_\_\_\_\_ him into the car and rushed to the nearest hospital. This same story had been heard before. On 22 November 1963 President John F Kennedy was riding in a motorcade through Dallas, Texas. He smiled and waved to the crowd that had gathered to see him. (iv) \_\_\_\_\_ rang out from a nearby building. The President collapsed into the backseat of the car and was immediately taken to the nearest hospital. He was (v) \_\_\_\_\_ dead at the hospital. Now, just seventeen years later, the news sounded eerily the same.

**SubQuestion No : 9**

**Q.9** Select the most appropriate option to fill in blank No. (v).

- Ans**
- 1. acting
  - 2. shot
  - 3. pronounced
  - 4. almost

**Q.10** Identify the most appropriate ANTONYM of the given word.  
Lenient

- Ans**
- 1. Strict
  - 2. Rude
  - 3. Kind
  - 4. Rowdy

**Q.11** Read the sentence carefully and select the synonym of the underlined word from the given alternatives.

The Television show was hosted by a young and vivacious woman called Laura.

- Ans**
- 1. Legendary
  - 2. Atrocious
  - 3. Liberal
  - 4. Energetic

**Q.12** Select the most appropriate option that can substitute the underlined segment in the given sentence.

The woman lost much to her body weight due to diabetes.

- Ans**
- 1. from her body weight due to
  - 2. for her body weight due to
  - 3. off her body weight due to
  - 4. of her body weight due to

Q.13 Select the most appropriate synonym of the given word.  
Abscond

- Ans
- 1. Flee
  - 2. Avoid
  - 3. Annoy
  - 4. Stay

Q.14 Select the most appropriate option that can substitute the underlined segment in the given sentence.  
In every country of the world, primary caregivers are the women of children and elders.

- Ans
- 1. women are the caregivers primary of
  - 2. the women primary caregivers are of
  - 3. primary caregivers women are of the
  - 4. women are the primary caregivers of

Q.15 Select the appropriate meaning of the given idiom.  
Last resort

- Ans
- 1. Last hotel on the way
  - 2. Last ride
  - 3. Last friend remaining
  - 4. Last course of action

Q.16 Select the most appropriate synonym of the given word.  
Confidential

- Ans
- 1. Public
  - 2. Limited
  - 3. Secret
  - 4. Open source

Q.17 Select the most appropriate ANTONYM of the given word.  
Adverse

- Ans
- 1. Listless
  - 2. Striking
  - 3. Propitious
  - 4. Critical

Q.18 Select the most appropriate option to fill in the blank.  
She \_\_\_\_\_ gracefully and greeted the interview committee with respect.

- Ans
- 1. grinned
  - 2. leered
  - 3. smiled
  - 4. smirked

Q.19 Select the most appropriate spelling of the underlined word in the given sentence.  
Nobody could move on after such a scandalous allegation is made on them.

- Ans
- 1. skandelous
  - 2. scandalous
  - 3. scandelous
  - 4. scendolous

Q.20 Select the most appropriate synonym of the given word.  
Interpret

- Ans
- 1. Clarify
  - 2. Cleanse
  - 3. Celebrate
  - 4. Complicate

Q.21 Select the most appropriate option that can substitute the underlined segment in the given sentence.

I will require a quiet room to work at.

- Ans
- 1. on
  - 2. about
  - 3. with
  - 4. in

Q.22 Choose the most appropriate meaning of the given idiom.  
Ace in the hole

- Ans
- 1. A lot to do
  - 2. On the point of
  - 3. A second chance to do something
  - 4. A hidden advantage

Q.23 Select the most appropriate synonym of the bracketed word in the following sentence to fill in the blank.  
Lead paint is an environmental \_\_\_\_\_ (danger) and can harm children.

- Ans
- 1. conflict
  - 2. empathy
  - 3. toil
  - 4. hazard

Q.24 Select the most appropriate option that can substitute the underlined segment in the given sentence.

Gulliver hear his watch ticking in his pocket.

- Ans
- 1. heard his watch tickling
  - 2. watch ticking
  - 3. could hear his watch ticking
  - 4. could hear his watch ticked

Q.25 Select the INCORRECTLY spelt word.

- Ans
- 1. Aspirant
  - 2. License
  - 3. Autonomous
  - 4. Ommision

Section : General Intelligence

1. 'Z + Y' means 'Z is the father of Y'  
'Z - Y' means 'Z is the mother of Y'  
'Z × Y' means 'Z is the brother of Y'  
'Z ÷ Y' means 'Z is the sister of Y'.  
What does 'A × B - C' mean?

- Ans
- 1. A is the father's father of C
  - 2. A is the father of C
  - 3. A is the mother's brother of C
  - 4. A is the father's brother of C

**Q.2** Three statements are followed by conclusions numbered I, II. You have to consider these statements to be true, even if they seem to be at variance with commonly known facts. Decide which of the given conclusions logically follow/s from the given statement.

**Statements:**

All paints are houses.

All houses are wood.

Some streets are wood.

**Conclusion (I):** Some streets are houses.

**Conclusion (II):** All paints are wood.

- Ans**
- 1. Both conclusions (I) and (II) follow.
  - 2. Only conclusion (II) follows.
  - 3. Only conclusion (I) follows.
  - 4. Neither conclusion (I) nor (II) follows.

**3.** Select the correct option that when filled in the blanks in the same sequence will make the series logically complete.  
TRIC\_TRI\_KT\_IWK\_R\_TK

- Ans**
- 1. KIRTA
  - 2. KATIR
  - 3. KBTIR
  - 4. KZRTI

**Q.4** Identify the figure in the options that when put in place of the question mark (?) will logically complete the series?

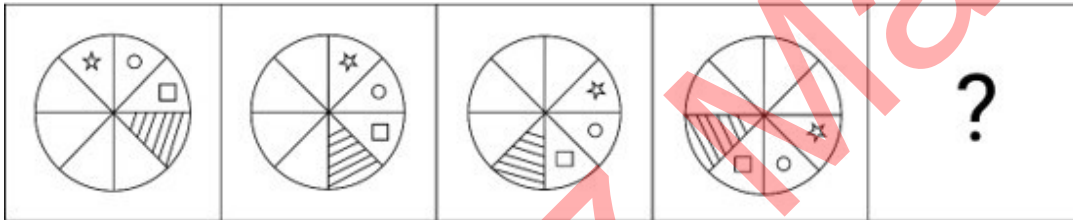

**Ans**

- 1.
- 2.
- 3.
- 4.

Q.5 Select the correct mirror image of the given figure when the mirror is placed at MN as shown below.



- Ans
- 1. V209G5
  - 2. 5G902V
  - 3. 5G902V
  - 4. 5G902V

Q.6 What is opposite to 'V' when the given figure is folded to form a cube?

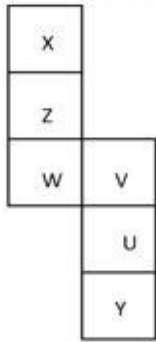

- Ans
- 1. W
  - 2. Y
  - 3. Z
  - 4. X

Q.7 What will come in the place of '?' in the following equation, if '+' and '-' are interchanged and '×' and '÷' are interchanged?

$$66 \times 11 - 26 + 3 \div 9 = ?$$

- Ans
- 1. 5
  - 2. 15
  - 3. 8
  - 4. 11

Q.8 If 3 April 1996 was Wednesday, then what was the day of the week on 7 April 2001?

- Ans
- 1. Sunday
  - 2. Monday
  - 3. Friday
  - 4. Saturday

Q.9 If 15 January 2019 was a Tuesday, then what day of the week was it on 29 January 2020?

- Ans
- 1. Wednesday
  - 2. Tuesday
  - 3. Thursday
  - 4. Friday

**Q.10** In a certain code language, 'MENIAL' is coded as 'NIEAML' and 'INCOME' is coded as 'CONMIE'. What is the code for 'FOREGO' in the given code language?

- Ans**
- 1. OFOREG
  - 2. FOGERO
  - 3. OGEROF
  - 4. REOGFO

**Q.11** What should come in place of the question mark (?) in the given series based on the English alphabetical order?  
ECZ, HFC, KIF, NLI, ?

- Ans**
- 1. OLQ
  - 2. QOL
  - 3. OQL
  - 4. QLO

**Q.12** What should come in place of the question mark (?) in the given series?  
499, 498, 490, 463, 399, ?

- Ans**
- 1. 273
  - 2. 275
  - 3. 274
  - 4. 276

**Q.13** HJKN is related to EGHK in a certain way based on the English alphabetical order. In the same way, QSTW is related to NPQT. To which of the following is IKLO related, following the same logic?

- Ans**
- 1. FHIL
  - 2. FHJL
  - 3. FGIL
  - 4. FHIK

**Q.14** Which of the following numbers will replace the question mark (?) in the given series?  
549    482    439    372    329    262    219    ?

- Ans**
- 1. 152
  - 2. 149
  - 3. 132
  - 4. 162

Q.15 How many triangles are there in the given figure?

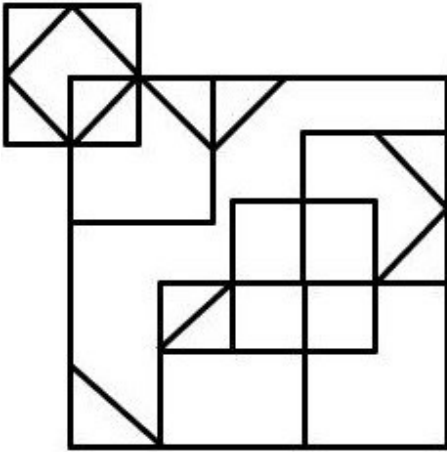

- Ans
- 1. 14
  - 2. 11
  - 3. 13
  - 4. 12

Q.16 Select the correct mirror image of the given combination when the mirror is placed at MN as shown below.

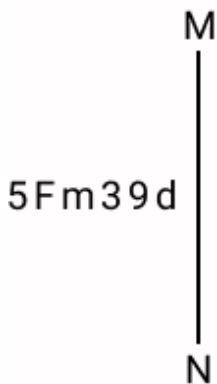

- Ans
- 1. d93w75
  - 2. b39m72
  - 3. 5fm39d
  - 4. 2fm39d

Q.17 Four letter-clusters have been given, out of which three are alike in some manner and one is different. Select the letter-cluster that is different.

(Note: The odd one out is not based on the number of consonants/vowels or their position in the letter cluster.)

- Ans
- 1. RWVU
  - 2. IMNL
  - 3. PUTS
  - 4. AFED

Q.18 Which of the following letter numeric clusters will replace the question mark (?) in the given series to make it logically complete?

JX 26, KY 31, ?, PD 47, TH 58

- Ans
- 1. NB 37
  - 2. MA 38
  - 3. NA 38
  - 4. MB 37



Q.19 In a certain code language, 'mobile switched off' is written as 'rq mg cr' and 'turn off light' is written as 'my cp rq'. How is 'off' written in the given language?

- Ans
- 1. cr
  - 2. mg
  - 3. rq
  - 4. cp

Q.20 What will come in the place of the question mark (?) in the following equation, if '+' and '-' are interchanged and '×' and '÷' are interchanged?

$$333 \times 3 + 11 - 5 \div 5 = ?$$

- Ans
- 1. 192
  - 2. 125
  - 3. 175
  - 4. 152

Q.21 Select the set in which the numbers are related in the same way as are the numbers of the following sets.  
(NOTE: Operations should be performed on the whole numbers, without breaking down the numbers into its constituent digits. E.g. 13 – Operations on 13 such as adding/deleting/multiplying etc. to 13 can be performed. Breaking down 13 into 1 and 3 and then performing mathematical operations on 1 and 3 is not allowed.)  
(10, 20, 4)  
(15, 30, 6)

- Ans
- 1. (20, 30, 8)
  - 2. (20, 40, 8)
  - 3. (10, 40, 8)
  - 4. (20, 40, 6)

Q.22 Select the correct mirror image of the given figure when the mirror is placed at MN as shown below.

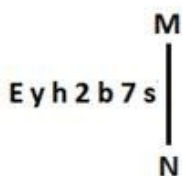

- Ans
- 1. E y h 2 b 7 s
  - 2. E y h 2 b 7 s
  - 3. E y h 2 b 7 s
  - 4. E y h 2 b 7 s

Q.23 Six numbers 1, 2, 5, 6, 8 and 9 are written on different faces of a dice. Two positions of this dice are shown in the figure. Which is the number on the face opposite to the face containing 8?

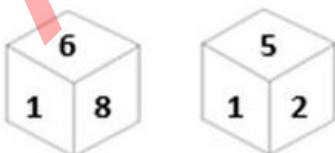

- Ans
- 1. 2
  - 2. 5
  - 3. 1
  - 4. 9

Q.24 72 is related to 96 following a certain logic. Following the same logic, 66 is related to 88. Which of the following numbers related is to 104 using the same logic?  
(NOTE : Operations should be performed on the whole numbers, without breaking down the numbers into its constituent digits. E.g. 13 – Operations on 13 such as adding / subtracting/multiplying etc. to 13 can be performed. Breaking down into 1 and 3 and then performing mathematical operations on 1 and 3 is not allowed)

- Ans
- 1. 75
  - 2. 77
  - 3. 78
  - 4. 80

Q.25 What will come in the place of the question mark (?) in the following equation, if '+' and '÷' are interchanged and '×' and '-' are interchanged?

$$16 - 33 + 11 \div 22 \times 5 = ?$$

- Ans
- 1. 60
  - 2. 62
  - 3. 65
  - 4. 69

Section : Quantitative Aptitude

Q.1 When a number is divided by 512 it leaves a remainder 67. If the same number is divided by 32, then what will be the remainder?

- Ans
- 1. 4
  - 2. 0
  - 3. 5
  - 4. 3

Q.2 Two stations T1 and T2 300 km apart. A car starts from station T1 at 8 am and moves towards station T2 at a speed of 45km/hr. and at 10 am another car starts from station T2 towards T1 at a speed of 60km/hr. Then the cars will meet at:

- Ans
- 1. 11:00 a.m.
  - 2. 1:00 p.m.
  - 3. 12:00 p.m.
  - 4. 10:00 a.m.

Q.3 The internal length, breadth and height of a cardboard box are 6 cm, 10 cm and 12 cm, respectively. How many boxes are needed in which cubes whose volume is  $2160 \text{ cm}^3$  can be packed?

- Ans
- 1. 4
  - 2. 3
  - 3. 6
  - 4. 5

Q.4 If a circle whose centre is (2, 3) touches the line  $4x + 3y - 7 = 0$ , then the radius of the circle is:

- Ans
- 1. 4 unit
  - 2. 1 unit
  - 3. 2 unit
  - 4. 3 unit

Q.5 If the radius of a sphere is doubled, then the volume of the sphere becomes \_\_\_\_\_ times the previous volume.

- Ans
- 1. eight
  - 2. two
  - 3. four
  - 4. one

Q.6 Monthly expenditure of Ritvik decreases from ₹12,800 to ₹11,712. Find the percentage decrease in his expenditure.

- Ans
- 1. 7.7%
  - 2. 6.25%
  - 3. 8.5%
  - 4. 9.25%

Q.7 In  $\Delta PQR$ , S and T are points on PQ and PR, respectively, such that  $ST \parallel QR$  and ST divides the  $\Delta PQR$  into two parts of equal areas. Then the ratio of PS and QS is:

- Ans
- 1.  $1 : \sqrt{2} - 1$
  - 2.  $1 : 1$
  - 3.  $1 : \sqrt{2} + 1$
  - 4.  $1 : \sqrt{2}$

Q.8 The marked price of an article is ₹600. A shopkeeper purchased it on two successive discounts of 10% and 20%. He spent ₹68 on transportation and sold the article for ₹600. Find his gain or loss percentage.

- Ans
- 1. 25% Loss
  - 2. 15% Profit
  - 3. 20% Profit
  - 4. 18% Loss

Q.9 Joey completed the school project in 15 days. How many days will Tim take to complete the same work if he is 25% more efficient than Joey?

- Ans
- 1. 8 days
  - 2. 10 days
  - 3. 12 days
  - 4. 16 days

Q.10 A retail fruit vendor buys a score of apples for ₹400 and retails them for ₹264 at a dozen. What was his loss/gain per cent? (a score = 20 no's)

- Ans
- 1. 20% profit
  - 2. 10% loss
  - 3. 10% profit
  - 4. 5% loss

Q.11 In an election between two candidates, the defeated candidate secured 42% of the valid votes polled and lost the election by 2545800 votes. If 365500 votes were declared invalid and 30% people did not cast their vote, what was the approximate number of people (in millions) in the electorate who did NOT cast their votes?

- Ans
- 1. 5
  - 2. 6
  - 3. 8
  - 4. 7

Q.12 In a circle with centre O, ABC is a secant intersecting the circle at A and B and DC is a tangent to the circle at D. If DC = 12 cm and BC = 6 cm, then the length of AB is equal to:

- Ans
- 1. 20 cm
  - 2. 18 cm
  - 3. 22 cm
  - 4. 16 cm

Q.13 An 8 digit number is divisible by 99. If the digits are shuffled, then the number is always divisible by \_\_\_\_\_.

- Ans
- 1. 6
  - 2. 9
  - 3. 5
  - 4. 11

Q.14 A and B are centres of two circles of radii 32 cm and 8 cm, respectively. CD is a direct common tangent to the circles. If the length of AB = 30 cm, then the length of CD will be:

- Ans
- 1. 10 cm
  - 2. 20 cm
  - 3. 9 cm
  - 4. 18 cm

Q.15 The given line graph shows the number of scooters manufactured (in thousands) by companies X and Z, over the years.

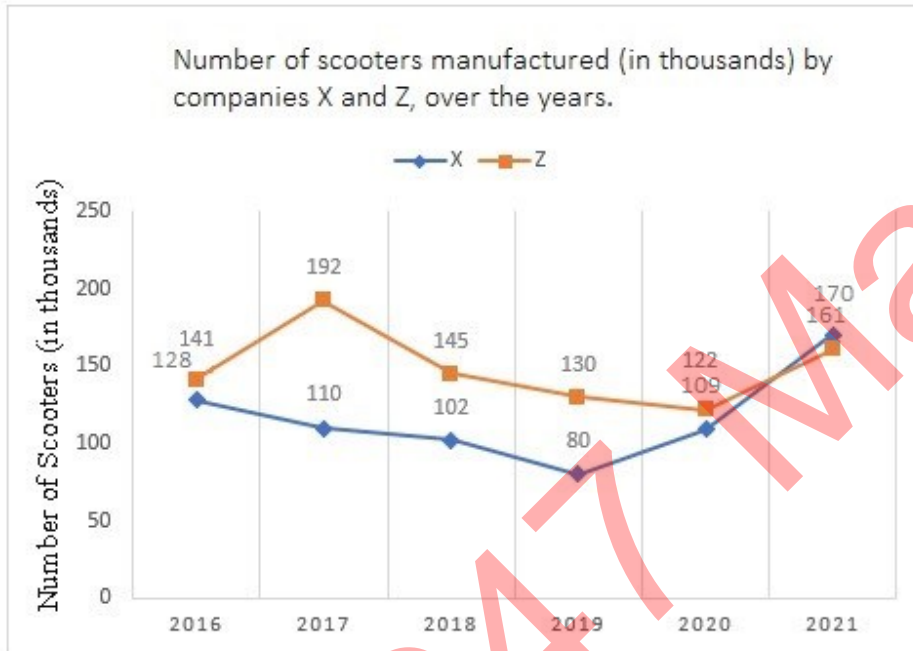

What is the approximate difference between the total production by companies X and Z in the given years?

- Ans
- 1. 205000
  - 2. 292000
  - 3. 192000
  - 4. 210000

Q.16 A bus driver must complete a 240 km trip in 4 hours. If he averages 70 km an hour for the first 3 hours of his trip, how fast must he travel (in km/h) in the last/final hour?

- Ans
- 1. 60
  - 2. 50
  - 3. 30
  - 4. 35

Q.17 In an election between two candidates, a candidate who gets 78% of the votes is elected by a majority of 448 votes. What is the total number of votes polled?

- Ans
- 1. 700
  - 2. 850
  - 3. 800
  - 4. 750

Q.18 Among the ratios 3 : 4, 5 : 8, 1 : 2, 6 : 9 which is the greatest?

Ans  1. 5 : 8

2. 3 : 4

3. 6 : 9

4. 1 : 2

Q.19 Study the given chart based on the population using different types of transport in the given cities. Assuming that no person uses more than one type of transport, answer the question that follows.

PEOPLE USING THE DIFFERENT TYPES OF TRANSPORT IN A CITY

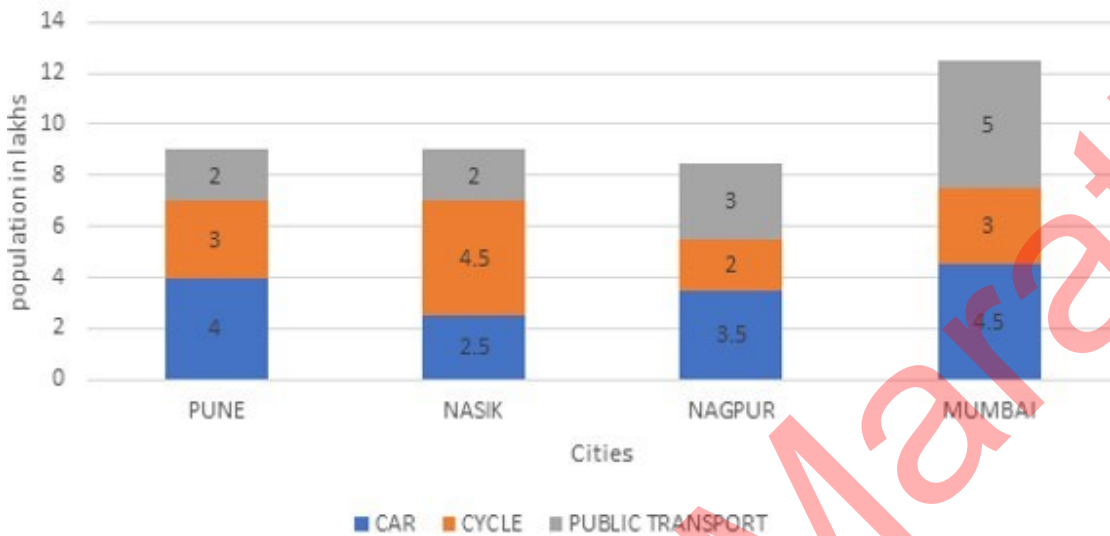

What is the percentage of people using all types of transportation in Pune to the total number of people using all types of transportation in all cities?

Ans  1. 23.08%

2. 22.08%

3. 33.08%

4. 28.08%

Q.20 The heights of two cones are in the ratio of 5 : 3 and their radii are in the ratio 6 : 5. Find the ratio of their volumes.

Ans  1. 11 : 5

2. 10 : 5

3. 12 : 5

4. 13 : 5

Q.21 The following table shows the production of cars in a company from 2016 to 2020.

Years	2016	2017	2018	2019	2020
A	30	23	39	25	18
B	16	10	14	12	8
C	15	18	19	25	30
D	31	12	21	19	20

There was a continuous increase in the production of cars of which type during the period 2016 to 2020?

Ans  1. D

2. C

3. A

4. B

Q.22 What is the present worth of ₹2,400 due in 4 years at a rate of 5% simple interest per annum?

- Ans
- 1. ₹2,240
  - 2. ₹2,000
  - 3. ₹2,456
  - 4. ₹2,200

Q.23  $(\cot \theta + \tan \theta)(\operatorname{cosec} \theta - \sin \theta)(\cos \theta - \sec \theta) = \underline{\hspace{2cm}}$ .

- Ans
- 1. 0
  - 2. 1
  - 3. 2
  - 4. -1

Q.24 Study the given pie-chart and answer the question that follows.

The pie-chart represents the total number of valid votes obtained by four students who contested for school leadership. The total number of valid votes polled was 720.

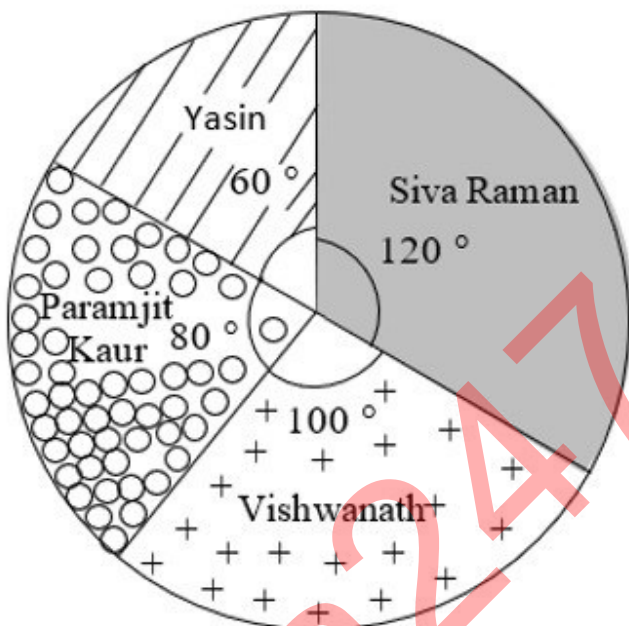

What is the minimum number of votes obtained by any candidate?

- Ans
- 1. 240
  - 2. 120
  - 3. 160
  - 4. 200

Q.25 The length of the portion of the straight line  $5x + 12y = 60$  intercepted between the axes

- is: Ans
- 1. 5
  - 2. 13
  - 3. 17
  - 4. 12

1. Which of the following statements about climate is INCORRECT?

- Ans
- 1. Coastal areas of India experience less contrasts in temperature conditions as compared to the interior of the country.
  - 2. India experiences comparatively stronger winters as compared to central Asia.
  - 3. India's climate has characteristics of tropical as well as subtropical climates.
  - 4. 'Monsoon' type of climate is found mainly in south and southeast Asia.

2. What kind of technology is most frequently used to manage and digitise e-land records?

- Ans
- 1. Blockchain
  - 2. Augmented Reality (AR)
  - 3. Geographic Information System (GIS)
  - 4. Virtual Reality (VR)

3. What is the main sense organ that virtual reality displays are aiming for?

- Ans
- 1. Smell
  - 2. Taste
  - 3. Vision
  - 4. Touch

Q.4 According to Census of India 2011, which of the following states recorded the least population?

- Ans
- 1. Tamil Nadu
  - 2. Gujarat
  - 3. Sikkim
  - 4. Punjab

Q.5 Which state is introduced India's first 'Right to Health Care Act, 2022'?

- Ans
- 1. Kerala
  - 2. Rajasthan
  - 3. Assam
  - 4. Chhattisgarh

Q.6 In May 2023, the Supreme Court of India issued a set of directions to strengthen the POSH Act. To which of the following is this Act related?

- Ans
- 1. Food security
  - 2. Sexual harassment of women at workplace
  - 3. Amenities in jails
  - 4. Child trafficking

Q.7 Which is the largest part of the northern plains and is formed of older alluvium?

- Ans
- 1. Terai
  - 2. Bhangar
  - 3. Khadar
  - 4. Bhabar

Q.8 According to the Census of India, who are considered to be literates?

- Ans
- 1. Person aged eighteen and above, who can both read and write with understanding in any language
  - 2. Person aged seven and above, who can both read and write with understanding in any language
  - 3. Person aged five and above, who can both read and write with understanding in any language
  - 4. Person aged fifteen and above, who can both read and write with understanding in any language

Q.9 Which of the following enzymes are essential of DNA replication in an animal cell?

- Ans
- 1. Reverse transcriptase, DNA polymerase, DNA primase
  - 2. Topoisomerase, DNA ligase, DNA polymerase, DNA primase
  - 3. Reverse transcriptase, RNA polymerase, Ligase
  - 4. Reverse transcriptase, DNA polymerase, Ligase

Q.10 Certiorari comes under the:

- Ans
- 1. right against exploitation
  - 2. right to constitutional remedies
  - 3. right to equality
  - 4. right to religious freedom

Q.11 Balban followed the tradition of 'Sijda and Pabos' from which of following traditions?

- Ans
- 1. Persian
  - 2. Chinese
  - 3. Mangol
  - 4. Roman

Q.12 Which of the following statements is correct with respect to the Badminton game and match length?

- Ans
- 1. A match consists of the best of five games of 21 points.
  - 2. A match consists of the best of two games of 21 points.
  - 3. A match consists of the best of four games of 21 points.
  - 4. A match consists of the best of three games of 21 points.

Q.13 Which of the following statements are true?

- i. The First Five-Year Plan was based on the PC Mahalanobis model.
- ii. The First Five-Year Plan laid emphasis on agriculture development.
- iii. The Five-Year planning model in India was borrowed from Russia.

- Ans
- 1. Only ii and iii
  - 2. Only i and iii
  - 3. Only i and ii
  - 4. i, ii and iii

Q.14 Match the following names of primitive forms of cultivation in different states correctly.

States	Name of Primitive form of cultivation
1. Madhya Pradesh	a. Penda
2. Andhra Pradesh	b. Bewar
3. Odisha	c. Kuruwa
4. Jharkhand	d. Bringa

- Ans
- 1. 1-b, 2-a, 3-d, 4-c
  - 2. 1-a, 2-b, 3-c, 4-d
  - 3. 1-a, 2-b, 3-d, 4-c
  - 4. 1-b, 2-a, 3-c, 4-d



Q.15 Jamshedi Navroz is a festival of \_\_\_\_\_ community.

- Ans
- 1. Hindu
  - 2. Jain
  - 3. Parsi
  - 4. Christian

Q.16 Indian athlete Shaili Singh won bronze medal in women's long jump at the Golden Grand Prix 2023 athletics meet held at \_\_\_\_\_.

- Ans
- 1. South Korea
  - 2. Japan
  - 3. Singapore
  - 4. Malaysia

Q.17 Which of the following Indian classical dances has originated from Andhra Pradesh?

- Ans
- 1. Odissi
  - 2. Mohiniattam
  - 3. Kathakali
  - 4. Kuchipudi

Q.18 Which from following unemployment scheme was extended by the government of India for a period of two years from July 2022 to June 2024?

- Ans
- 1. Aatmanirbhar Bharat Rojgar Yojana
  - 2. Pradhan Mantri Berojgari Bhatta Yojana
  - 3. Grameen Udyami Yojana
  - 4. Atal Beemit Vyakti Kalyan Yojana

Q.19 The Ghadar Party was founded in \_\_\_\_\_ by Sohan Singh Bhakna, Kanshi Ram, Harnam Singh Tundilat, Lala Har Dayal and others.

- Ans
- 1. 1901
  - 2. 1913
  - 3. 1905
  - 4. 1910

Q.20 Which folk music of Jammu and Kashmir is sung in wedding ceremonies?

- Ans
- 1. Baul
  - 2. Alha
  - 3. Panihari
  - 4. Wanawun

Q.21 Who was the first female Indian wrestler to win Gold at the Commonwealth Games?

- Ans
- 1. Geeta Phogat
  - 2. Babita Phogat
  - 3. Sakshi Malik
  - 4. Alka Tomar

Q.22 \_\_\_\_\_ Fundamental Duties were added in Part-IV of the Constitution under Article 51-A in the year 1976 through the 42<sup>nd</sup> Constitutional Amendment.

- Ans
- 1. Eight
  - 2. Ten
  - 3. Twelve
  - 4. Nine

Q.23 In 2000-01, NABARD instituted Micro Finance Development Fund with a corpus of \_\_\_\_\_.

- Ans
- 1. ₹245 crores
  - 2. ₹100 crores
  - 3. ₹150 crores
  - 4. ₹189 crores

Q.24 The Yakshagana is the dance-drama primarily associated with which of the following states?

- Ans
- 1. Himachal Pradesh
  - 2. Karnataka
  - 3. Bihar
  - 4. Odisha

Q.25 In which year did Hans Christian Oersted discover that a compass needle gets deflected when an electric current passes through a metallic wire placed nearby?

- Ans
- 1. 1826
  - 2. 1824
  - 3. 1820
  - 4. 1822

Adda247 Marathi

## Combined Higher Secondary Level Examination 2024 Tier I

Exam Date	03/07/2024
Exam Time	11:45 AM - 12:45 PM
Subject	CHSL Exam 2024 Tier I

### Section : English Language

1. The following sentence has been divided into four segments. Identify the segment that contains a grammatical error. The meeting / will taking / place next / Wednesday.

- Ans
- 1. place next
  - 2. will taking
  - 3. The meeting
  - 4. Wednesday.

2. The following sentence has been split into four segments. Identify the segment that contains a grammatical error. Urgent activities are those things / that you must do immediately, / as they require quick action / and cannot be put on.

- Ans
- 1. and cannot be put on
  - 2. that you must do immediately
  - 3. Urgent activities are those things
  - 4. as they require quick action

Q.3 The following sentence has been split into four segments. Identify the segment that contains a grammatical error. (1) When Christy (2) grew out, (3) he turned out (4) to be a gentleman.

- Ans
- 1. 4
  - 2. 3
  - 3. 2
  - 4. 1

Q.4 The following sentence has been split into four segments. Identify the segment that contains a grammatical error. Rashmi was / quite amusing when / she heard about / what had happened.

- Ans
- 1. Rashmi was
  - 2. quite amusing when
  - 3. she heard about
  - 4. what had happened

**Comprehension:**

In the following passage, some words have been deleted. Read the passage carefully and select the most appropriate option to fill in each blank.

There is nothing more (1)\_\_\_\_\_ than when you sit down at your table to study with the most sincere of intentions and instead of being able to finish the task at hand you find your thoughts (2)\_\_\_\_\_. However, there are certain techniques that you can use to (3)\_\_\_\_\_ your concentration. To begin with, one should (4)\_\_\_\_\_ to create the physical environment that is conducive to (5)\_\_\_\_\_ thought.

**SubQuestion No : 5**

**Q.5 Select the most appropriate option to fill in blank no. 1**

- Ans**
- 1. exciting
  - 2. frustrating
  - 3. surprising
  - 4. interesting

**Comprehension:**

In the following passage, some words have been deleted. Read the passage carefully and select the most appropriate option to fill in each blank.

There is nothing more (1)\_\_\_\_\_ than when you sit down at your table to study with the most sincere of intentions and instead of being able to finish the task at hand you find your thoughts (2)\_\_\_\_\_. However, there are certain techniques that you can use to (3)\_\_\_\_\_ your concentration. To begin with, one should (4)\_\_\_\_\_ to create the physical environment that is conducive to (5)\_\_\_\_\_ thought.

**SubQuestion No : 6**

**Q.6 Select the most appropriate option to fill in blank no. 2.**

- Ans**
- 1. worrying
  - 2. tiring
  - 3. interesting
  - 4. wandering

**Comprehension:**

In the following passage, some words have been deleted. Read the passage carefully and select the most appropriate option to fill in each blank.

There is nothing more (1)\_\_\_\_\_ than when you sit down at your table to study with the most sincere of intentions and instead of being able to finish the task at hand you find your thoughts (2)\_\_\_\_\_. However, there are certain techniques that you can use to (3)\_\_\_\_\_ your concentration. To begin with, one should (4)\_\_\_\_\_ to create the physical environment that is conducive to (5)\_\_\_\_\_ thought.

**SubQuestion No : 7**

**Q.7 Select the most appropriate option to fill in blank no. 3.**

- Ans**
- 1. enhance
  - 2. convince
  - 3. commit
  - 4. discover

**Comprehension:**

In the following passage, some words have been deleted. Read the passage carefully and select the most appropriate option to fill in each blank.

There is nothing more (1)\_\_\_\_\_than when you sit down at your table to study with the most sincere of intentions and instead of being able to finish the task at hand you find your thoughts (2)\_\_\_\_\_. However, there are certain techniques that you can use to (3)\_\_\_\_\_your concentration. To begin with, one should (4)\_\_\_\_\_to create the physical environment that is conducive to (5)\_\_\_\_\_thought.

**SubQuestion No : 8**

**Q.8 Select the most appropriate option to fill in blank no. 4.**

- Ans**
- 1. attempt
  - 2. announce
  - 3. imagine
  - 4. lead

**Comprehension:**

In the following passage, some words have been deleted. Read the passage carefully and select the most appropriate option to fill in each blank.

There is nothing more (1)\_\_\_\_\_than when you sit down at your table to study with the most sincere of intentions and instead of being able to finish the task at hand you find your thoughts (2)\_\_\_\_\_. However, there are certain techniques that you can use to (3)\_\_\_\_\_your concentration. To begin with, one should (4)\_\_\_\_\_to create the physical environment that is conducive to (5)\_\_\_\_\_thought.

**SubQuestion No : 9**

**Q.9 Select the most appropriate option to fill in blank no. 5.**

- Ans**
- 1. dazzling
  - 2. focussed
  - 3. cautious
  - 4. joyful

**Q.10 Select the most appropriate option to fill in the blank.**

**My sister's paintings were \_\_\_\_\_ at the national museum.**

- Ans**
- 1. in display
  - 2. on display
  - 3. upon display
  - 4. into display

**Q.11 Select the most appropriate meaning of the given idiom.**  
**Stick to one's guns**

- Ans**
- 1. To become a rebel
  - 2. To shoot at
  - 3. To become unfaithful to
  - 4. To remain faithful to

**Q.12 Select the INCORRECTLY spelt word.**

- Ans**
- 1. Litratue
  - 2. Reformation
  - 3. Schedule
  - 4. Miserable

Q.13 Select the most appropriate option that can replace the bracketed word segment in the following sentence.  
An (imperfect positioning) of the Sun, Earth and Moon results in the Moon passing through only part of Earth's umbra, resulting in a partial lunar eclipse.

- Ans
- 1. imperfect alliance
  - 2. imperfect revolution
  - 3. imperfect allegiance
  - 4. imperfect alignment

Q.14 Select the option that can substitute the bracketed word segment meaningfully.  
The city of Hyderabad is located (on the heart from Telangana).

- Ans
- 1. with the heart in Telangana
  - 2. in the heart with Telangana
  - 3. of the heart in Telangana
  - 4. in the heart of Telangana

Q.15 Select the most appropriate ANTONYM of the underlined word in the given sentence.  
Anthony Trollope was an industrious and disciplined writer.

- Ans
- 1. Exhausting
  - 2. Skittish
  - 3. Dizzy
  - 4. Lazy

Q.16 Select the most appropriate ANTONYM of the word 'Contaminate' from the given sentence.  
She spent the entire night working non-stop to clean the blood stains from the rug.

- Ans
- 1. rug
  - 2. spent
  - 3. working
  - 4. clean

Q.17 Select the most appropriate synonym of the given word.  
Frivolity

- Ans
- 1. Consequence
  - 2. Substantial
  - 3. Meaningful
  - 4. Insignificance

Q.18 Select the most appropriate meaning of the given idiom.  
Have a bee in your bonnet

- Ans
- 1. Be preoccupied or obsessed with something
  - 2. Unable to stay at a place for long
  - 3. To keep worrying about yourself
  - 4. Having a cruel intention or grudge against someone

Q.19 Select the most appropriate option that can substitute the underlined segment in the given sentence.  
There is no way I can swallow the ghastly medicine.

- Ans
- 1. horrible
  - 2. comforting
  - 3. agreeable
  - 4. pleasant

Q.20 Select the most appropriate option that can substitute the underlined word in the given sentence.

The recent cloudburst completely dismantled the village and its people.

- Ans
- 1. took back
  - 2. took apart
  - 3. took after
  - 4. took up

Q.21 Select the most appropriate ANTONYM of the underlined word in the given sentence.  
Please don't touch that, it's flammable .

- Ans
- 1. Non-combustible
  - 2. Nonexplosive
  - 3. Incendiary
  - 4. Fire-resistant

Q.22 Select the INCORRECTLY spelt word.

- Ans
- 1. Immigrete
  - 2. Combat
  - 3. Relevant
  - 4. Professional

Q.23 Select the most appropriate option that can substitute the underlined segment in the given sentence.

The new chief is gifted at the power of eloquence.

- Ans
- 1. gifted with
  - 2. gifted for
  - 3. gifted among
  - 4. gifted of

Q.24 Select the most appropriate ANTONYM of the given word.  
Fastidious

- Ans
- 1. Scrupulous
  - 2. Lax
  - 3. Late
  - 4. Speedy

Q.25 Select the option that will improve the underlined part of the given sentence.

I was looking for a barren seat in the bus but could not find one.

- Ans
- 1. hollow seat
  - 2. deserted seat
  - 3. vacant seat
  - 4. vacuous seat

Section : General Intelligence

1. If 17 August 2003 was a Sunday, then what was the day of the week on 12 September 2014?

- Ans
- 1. Sunday
  - 2. Friday
  - 3. Monday
  - 4. Wednesday

Q.2 Select the option that is embedded in the given figure (rotation is NOT allowed).

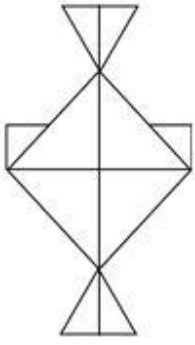

Ans

✗ 1.

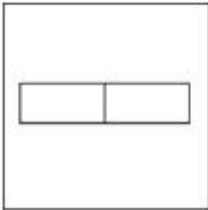

✗ 2.

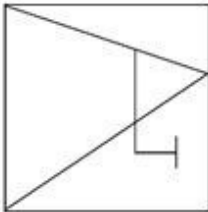

✗ 3.

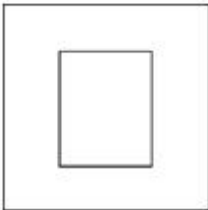

✓ 4.

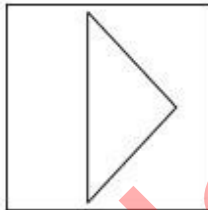

3. In this question, three statements are given, followed by three conclusions numbered I, II and III. Assuming the statements to be true, even if they seem to be at variance with commonly known facts, decide which of the conclusion(s) logically follows/follow from the statements.

Statements:

No pen is a scale.

All scales are erasers.

All pens are calculators.

Conclusions:

I. Some erasers are calculators.

II. No pen is an eraser.

III. No scale is a calculator.

Ans

✗ 1. Both conclusions II and III follow.

✓ 2. Neither conclusions I, II nor III follows.

✗ 3. All conclusions I, II and III follow.

✗ 4. Both conclusions I and II follow.



Q.4 Select the correct mirror image of the given figure when the mirror is placed at MN.

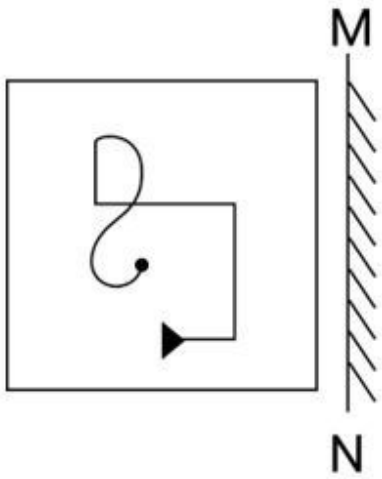

Ans

X 1.

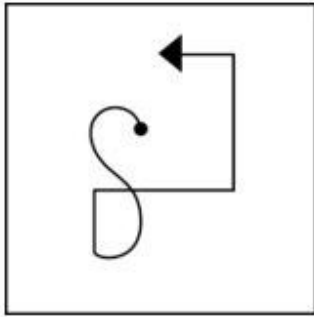

X 2.

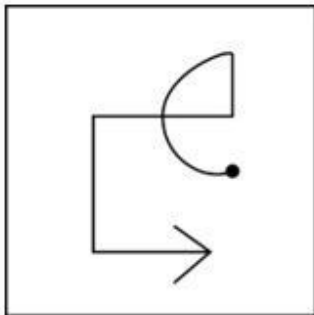

✓ 3.

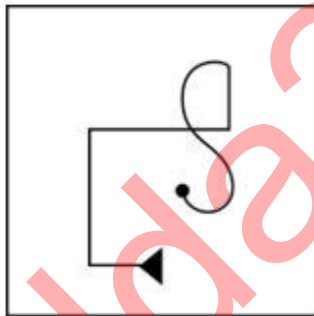

X 4.

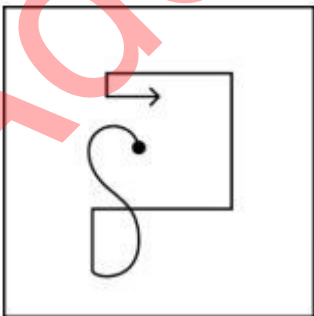

Q.5 Identify the figure in the options that when put in place of the question mark (?) will logically complete the series?

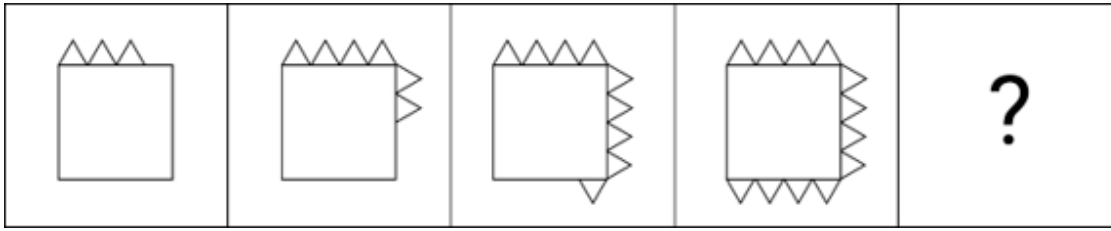

Ans

X 1.

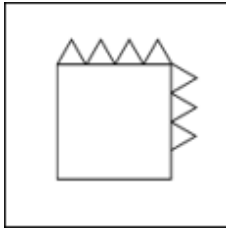

✓ 2.

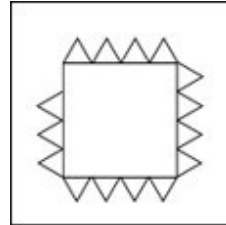

X 3.

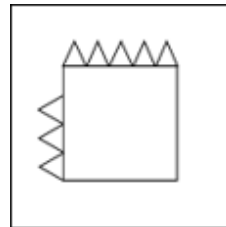

X 4.

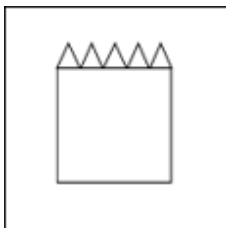

Q.6 In a certain code language, 'COVER' is coded as '9 - 45 - 66 - 15 - 54' and 'BOAST' is coded as '6 - 45 - 3 - 57 - 60'. What is the code for 'APRON' in the given code language?

Ans X 1. 2-46-52-40-41

✓ 2. 3-48-54-45-42

X 3. 2-46-52-44-40

X 4. 4-47-53-42-40

Q.7 In a certain code language, COMB is coded as 2681 and MOBE is coded as 8163. What is the code of E in that language?

Ans X 1. 6

✓ 2. 3

X 3. 1

X 4. 8

Q.8 Select the correct mirror image of the given combination when the mirror is placed at MN as shown below.



- Ans
- 1. E1r3sW
  - 2. Ws3rE
  - 3. E1r3sM
  - 4. hrE3sW

Q.9 Select the word-pair that best represents a similar relationship to the one expressed in the pair of words given below.

(The words must be considered as meaningful English words and must not be related to each other based on the number of letters/number of consonants/vowels in the word)

Proud : Arrogant

- Ans
- 1. Wise : Ignorant
  - 2. Authentic : Genuine
  - 3. Trust : Doubt
  - 4. Offend : Praise

Q.10 In a certain code language,  
'A @ B' means 'A is the husband of B',  
'A # B' means 'A is the mother of B',  
'A & B' means 'A is the sister of B'.  
Based on the above, how is T related to P if 'P @ Q # R & S @ T'?

- Ans
- 1. Son's wife
  - 2. Daughter
  - 3. Sister
  - 4. Wife's sister

Q.11 Which of the following numbers will replace the question mark (?) in the given series?

7 28 84 336 1008 ?

- Ans
- 1. 3902
  - 2. 4128
  - 3. 3036
  - 4. 4032

Q.12 Select the combination of letters that when sequentially placed in the blanks of the given series will logically complete the series.

AB\_Z DEF\_ G\_IX JKL\_ M\_OV

- Ans
- 1. CYHWN
  - 2. YGHVN
  - 3. CYGWN
  - 4. CYHVN

Q.13 The position of how many letters will remain unchanged if each of the letters in the word MENTOR is arranged in the alphabetical order?

- Ans
- 1. Two
  - 2. None
  - 3. One
  - 4. Three

Q.14 'D + E' means 'D is the father of E'  
'D - E' means 'D is the sister of E'  
'D × E' means 'D is the mother of E'  
'D ÷ E' means 'D is the brother of E'.  
Which of the following represents 'K is the brother's daughter of L'?

- Ans
- 1.  $L - F + K - P$
  - 2.  $K - L \times X \div U$
  - 3.  $U + F + K \div P$
  - 4.  $L \div Z \times X - K$

Q.15 If 'Z' stands for '+', 'H' stands for '×', 'M' stands for '+' and 'T' stands for '-', what will come in place of the question mark (?) in the following equation?  
 $52 M 36 Z 18 T 46 H 19 = ?$

- Ans
- 1. -754
  - 2. -820
  - 3. -654
  - 4. -898

Adda247 Marathi

Q.16 A paper is folded and cut as shown below. How will it appear when unfolded?

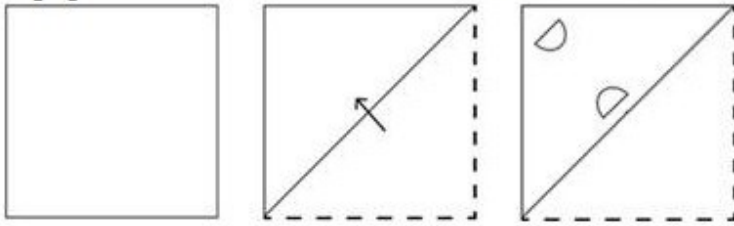

Ans

✗ 1.

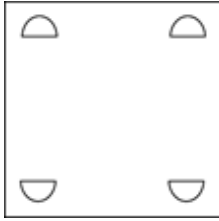

✗ 2.

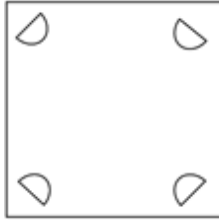

✓ 3.

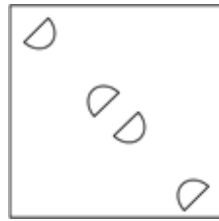

✗ 4.

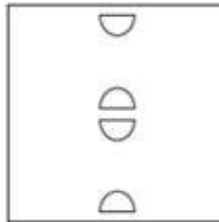

Q.17 What will come in the place of the question mark (?) in the following equation, if '+' and '-' are interchanged and '×' and '÷' are interchanged?

$$198 \times 9 + 29 - 7 \div 10 = ?$$

Ans

✗ 1. 61

✗ 2. 60

✗ 3. 62

✓ 4. 63

Q.18 Select the set in which the numbers are related in the same way as are the numbers of the following sets.  
 (NOTE: Operations should be performed on the whole numbers, without breaking down the numbers into its constituent digits. E.g. 13 – Operations on 13 such as adding/subtracting/multiplying etc. to 13 can be performed. Breaking down 13 into 1 and 3 and then performing mathematical operations on 1 and 3 is not allowed.)  
 (245, 49, 5)  
 (144, 9, 16)

Ans

✗ 1. (246, 9, 28)

✓ 2. (200, 8, 25)

✗ 3. (312, 24, 9)

✗ 4. (186, 21, 8)

Q.19 How many triangles are there in the given figure?

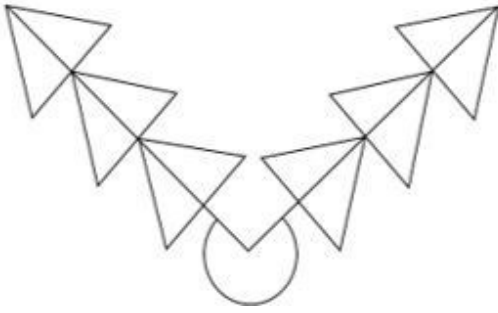

- Ans
- 1. 15
  - 2. 20
  - 3. 18
  - 4. 16

Q.20 What should come in place of ? in the given series based on the English alphabetical order?

PHO SRP VBQ ? BVS

- Ans
- 1. UMO
  - 2. CFE
  - 3. YLR
  - 4. VXY

Q.21 Six numbers 2, 3, 5, 7, 8 and 9 are written on different faces of a dice. Two positions of this dice are shown in the figure. Which is the number on the face opposite to the face containing 5?

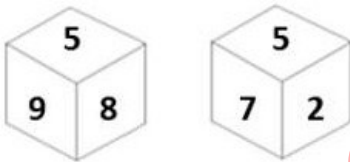

- Ans
- 1. 9
  - 2. 2
  - 3. 3
  - 4. 8

Q.22 Select the word-pair that best represents a similar relationship to the one expressed in the pair of words given below. (The words must be considered as meaningful English words and must not be related to each other based on the number of letters/consonants/vowels in the word.)

Pleasure : Delight

- Ans
- 1. Silly : Serious
  - 2. Rain : Sky
  - 3. Knowledge : Book
  - 4. Demolish : Destroy

Q.23 100 is related to 20 following a certain logic. Following the same logic, 250 is related to 50. To which of the following is related, 550 following the same logic?

(NOTE: Operations should be performed on the whole numbers, without breaking down the numbers into its constituent digits. E.g. 13 – Operations on 13 such as adding /deleting /multiplying etc. to 13 can be performed. Breaking down 13 into 1 and 3 and then performing mathematical operations on 1 and 3 is not allowed)

- Ans
- 1. 105
  - 2. 110
  - 3. 115
  - 4. 100

Q.24 If 'H' stands for '÷', 'A' stands for '+', 'B' stands for '-' and 'L' stands for '×', what will come in place of the question mark (?) in the following equation?

$$84 H 42 A 63 L 46 B 23 = ?$$

- Ans
- 1. 2877
  - 2. 2482
  - 3. 2864
  - 4. 4632

Q.25 What should come in place of the question mark (?) in the given series?

91, 100, 109, 118, 127, ?

- Ans
- 1. 135
  - 2. 136
  - 3. 138
  - 4. 137

Section : Quantitative Aptitude

Q.1 Find the value of the following expression.

$$\sin(30 + \theta) - \cos(60 - \theta)$$

- Ans
- 1.  $2\sin(30 + \theta)$
  - 2. 1
  - 3.  $\frac{\sqrt{3}}{2}$
  - 4. 0

Q.2 A man invested a sum of ₹5,000 on simple interest for 5 years such that the rate of interest for the first 2 years is 10% per annum, for the next 3 years it is 12% per annum How much interest (in ₹), will he earn at the end of 5 years?

- Ans
- 1. 3180
  - 2. 2800
  - 3. 3000
  - 4. 2450

Q.3

In a right-angled triangle ABC such that  $\angle BAC = 90^\circ$  and AD is perpendicular to BC. If the area of  $\Delta ABC$  is  $63 \text{ cm}^2$ , area of  $\Delta ACD = 7 \text{ cm}^2$ , and  $AC = 5 \text{ cm}$ , then the length of BC is equal to:

- Ans
- 1. 10 cm
  - 2. 15 cm
  - 3. 18 cm
  - 4. 12 cm

Q.4 A sells a bike to B at 45% profit. Then B sells it to C at 30% profit. If C pays ₹43,355, then what is the cost price of the bike for A?

- Ans
- 1. ₹23,000
  - 2. ₹27,000
  - 3. ₹29,000
  - 4. ₹21,000

Q.5 What is the area of the region created by the two linear equations  $2x + y = 6$  and  $2x - y = -2$  bounded by these lines and the x-axis?

- Ans
- 1. 5 sq. units
  - 2. 8 sq. units
  - 3. 3 sq. units
  - 4. 6 sq. units

Q.6

The following table shows admitted students in an institute during the academic years 2015 to 2020 in different courses.

Academic year	Engineering	Science	Arts	Management
2015	1200	850	450	240
2016	1362	821	525	275
2017	1351	870	624	286
2018	1409	921	615	293
2019	1421	931	795	300
2020	1400	950	750	320

Which course had the highest growth rate (in percentage) during the period from 2015 to 2020?

- Ans
- 1. Arts
  - 2. Management
  - 3. Engineering
  - 4. Science

Q.7 A circle of diameter 26 cm has two equal parallel chords of length 10 cm each, then the distance between the two chords is:

- Ans
- 1. 23 cm
  - 2. 26 cm
  - 3. 21 cm
  - 4. 24 cm



Q.8 Following Pie chart presents monthly expenditure by Sushma and Preeti in different heads. Sushma and Preeti make equal expenditure every month.

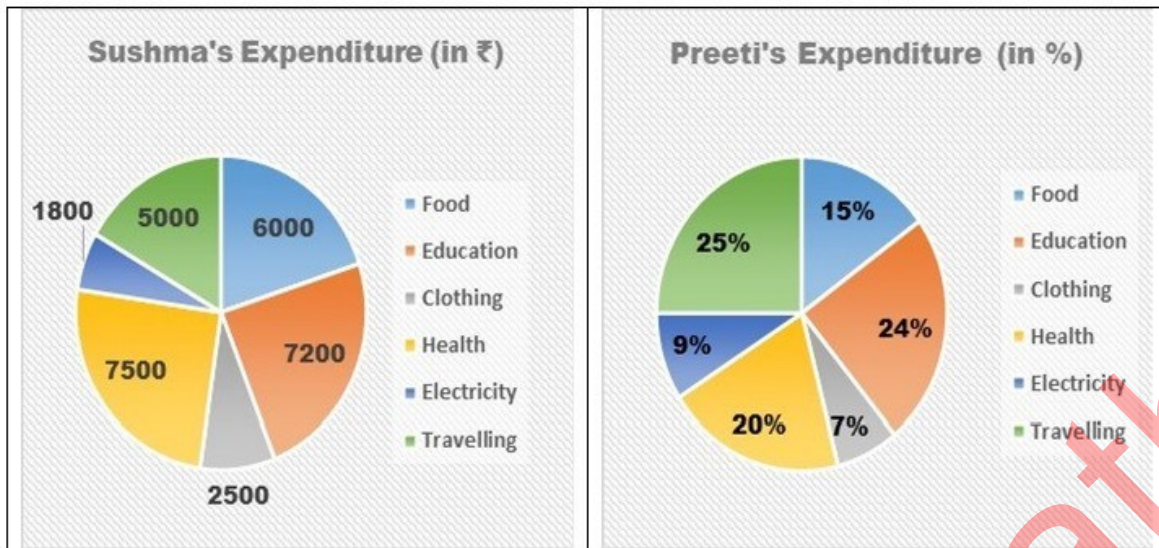

What is the ratio of central angles of expenditure on Education incurred by Sushma and Preeti?

- Ans
- 1. 2:3
  - 2. 1:2
  - 3. 1:1
  - 4. 2:1

Q.9 Two circles touch each other externally at M. PQ is a direct common tangent to the two circles, P and Q are points of contact and  $\angle MPQ = 38^\circ$ .  $\angle MQP$  is:

- Ans
- 1.  $38^\circ$
  - 2.  $52^\circ$
  - 3.  $42^\circ$
  - 4.  $48^\circ$

Q.10 A fraction  $\frac{3}{5}$  is decreased by  $\frac{2}{5}$ . The resulting fraction is then increased by 20%. What is the percentage decrease/increase in the value of the original fraction?

- Ans
- 1. Increase, 60%
  - 2. Decrease, 50%
  - 3. Increase, 50%
  - 4. Decrease, 60%

Q.11

Study the following bar chart, which represents the income and expenditure of a company.

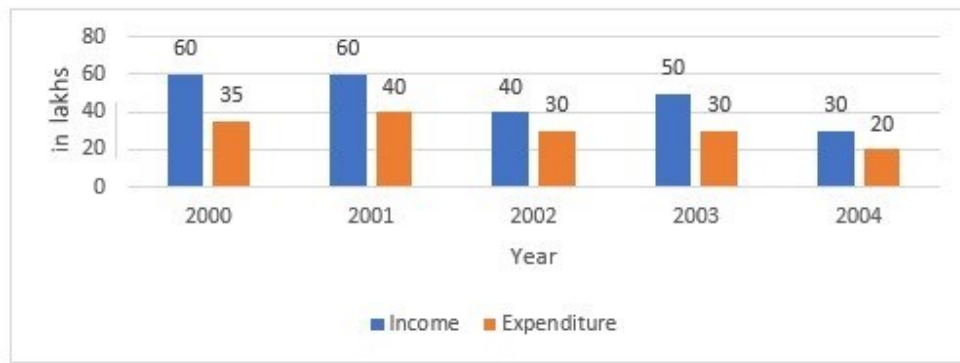

What is the difference of profit between the years 2001 and 2002?

Ans

- 1. 10 lakhs
- 2. 2 lakhs
- 3. 5 lakhs
- 4. 15 lakhs

Q.12

A policeman starts chasing a thief who is 500 m ahead of him. The speed of the thief is 18 km/h, and the speed of the policeman is 36 km/h. Find the time taken by the policeman to catch the thief.

Ans

- 1. 300 sec
- 2. 100 sec
- 3. 150 sec
- 4. 250 sec

Q.13 Find the remainder when  $179 \times 172 \times 173$  is divided by 17.

Ans

- 1. 3
- 2. 6
- 3. 9
- 4. 2

Q.14

By selling an article at 66% of its marked price, a merchant makes a profit of 10%. If he sells the article at 80% of its marked price, then the profit percentage will be:

Ans

- 1. 20 %
- 2.  $33\frac{1}{3}$  %
- 3. 25 %
- 4.  $33\frac{2}{3}$  %

Q.15 The value of  $(17 + 15) \div 2 - 11 + 16 \times 4 - 28 + 13(-16 + 13)$  is:

Ans

- 1. 3
- 2. 1
- 3. 0
- 4. 2

Q.16 The salaries of T in twelve months of a year are: ₹12,000, ₹12,000, ₹12,000, ₹15,000, ₹15,000, ₹15,000, ₹21,000, ₹21,000, ₹21,000, ₹30,000, ₹30,000, ₹30,000. The average salary of T per month in ₹ is \_\_\_\_\_.

- Ans
- 1. 19500
  - 2. 18500
  - 3. 18000
  - 4. 19000

Q.17 The curved surface area of a right circular cylinder of height 14 cm, is  $88 \text{ cm}^2$ . Find the total surface area of the cylinder.

- Ans
- 1.  $\frac{560}{7} \text{ cm}^2$
  - 2.  $\frac{360}{7} \text{ cm}^2$
  - 3.  $\frac{660}{7} \text{ cm}^2$
  - 4.  $\frac{460}{7} \text{ cm}^2$

Q.18 If  $a : b = 3 : 7$  and  $b : c = 4 : 9$ , then find  $a : b : c$ .

- Ans
- 1. 12 : 28 : 63
  - 2. 3 : 28 : 63
  - 3. 12 : 28 : 9
  - 4. 3 : 28 : 9

Q.19 A, B, C are three points such that  $AB = 11 \text{ cm}$ ,  $BC = 13 \text{ cm}$  and  $AC = 24 \text{ cm}$ . Number of circles passing through the points A, B, C is:

- Ans
- 1. 0
  - 2. 3
  - 3. 1
  - 4. 2

Q.20 A person wants to buy 10 chairs. The total cost of 10 chairs is ₹4,500. After bargaining, the shopkeeper agrees to decrease the cost of each chair by 20%. Then, the person purchased 10% more chairs. What will be the cost of the chairs that he purchased?

- Ans
- 1. ₹4,100
  - 2. ₹3,960
  - 3. ₹3,260
  - 4. ₹3,900

Q.21 18 men can complete  $\frac{1}{5}$  of a work in 10 days. How many people are required to complete  $\frac{2}{5}$  of the same work in 5 days?

- Ans
- 1. 36
  - 2. 90
  - 3. 72
  - 4. 54

Q.22 Ramana spends 75% of his income. His income is increased by 25% and he increases his expenditure by 10%. By what percentage are his savings increased?

- Ans
- 1. 60%
  - 2. 50%
  - 3. 70%
  - 4. 40%

Q.23 Study the given bar-graph and answer the question that follows.

The bar-graph shows the production (in lakh) of kitchen appliances manufactured by three companies A, B, and C over a period of six years from 2012 to 2017.



What is the difference (in lakh) between the average production of company B during the period 2012 to 2017 and the combined average of the production of company A in 2012, 2014, 2015 and the production of company C in 2014, 2016 and 2017, respectively?

- Ans
- 1. 25
  - 2. 40
  - 3. 30
  - 4. 50

Q.24 The area of a rectangular field is  $3600 \text{ m}^2$ . If the field is 45 m long, what is its perimeter?

- Ans
- 1. 260 m
  - 2. 255 m
  - 3. 265 m
  - 4. 250 m

Q.25 If the surface area of cuboid is  $108 \text{ m}^2$ , then find the height of the cuboid, whose length is 6 m and breadth is 3

- m. Ans
- 1. 4.5 m
  - 2. 4 m
  - 3. 5 m
  - 4. 5.5 m

1. We can add a table in an MS Word document from which of the following tabs?

- Ans
- 1. View Tab
  - 2. Home Tab
  - 3. Design Tab
  - 4. Insert Tab

Q.2 In which year was the first underground section (Vishwavidyalaya- Kashmere Gate) of the Golden Route opened in New Delhi?

- Ans
- 1. 2004
  - 2. 2000
  - 3. 1997
  - 4. 1998

3. Name the digital payment platform launched in 2021 by the National Payments Corporation of India (NPCI) in association with Department of Financial Services (DFS), National Health Authority (NHA) and Ministry of Health and Family Welfare (MoHFW).

- Ans
- 1. MobiKwik
  - 2. e-RUPI
  - 3. Dhani
  - 4. YONO

Q.4 Which Article of the Constitution mentions that "the Parliament consists of the President and two Houses known as the Council of States (Rajya Sabha) and the House of the People (Lok Sabha)"?

- Ans
- 1. 82
  - 2. 79
  - 3. 70
  - 4. 73

Q.5 Which of the following statements best describes the Hardy Schulze rule?

- Ans
- 1. The ions are removed from the solution by the phenomenon of diffusion through a permeable membrane.
  - 2. The partial pressure of a component in a liquid mixture is proportional to its mole fraction in that mixture.
  - 3. This is applied to obtain a colloidal solution of metals such as gold, silver or platinum.
  - 4. The amount of electrolyte required for the coagulation of a definite amount of a colloidal solution is dependent on the valency of the coagulating ion.

Q.6 What was the name of Swami Vivekanand's guru?

- Ans
- 1. Swami Ram Singh
  - 2. Swami Dayanand
  - 3. Aadi Shankaracharya
  - 4. Ramakrishna Paramhansa

Q.7 The Green Revolution was due to the introduction of:

- Ans
- 1. irrigation
  - 2. fertilisers
  - 3. high yielding varieties of seeds
  - 4. fisheries

Q.8 Guru Vempati Chinna Satyam is a famous dancer of \_\_\_\_\_ dance form of India.

- Ans
- 1. Bharatanatyam
  - 2. Manipuri
  - 3. Odissi
  - 4. Kuchipudi

Q.9 The famous book 'Sangraha Choodamani', which deals with the current system of Carnatic music was written by:

- Ans
- 1. Damodara Misra
  - 2. Matanga
  - 3. Haripala
  - 4. Govindacharya

Q.10 Kiran Nadar was conferred with the highest civilian award of which country in April 2023?

- Ans
- 1. France
  - 2. Poland
  - 3. Egypt
  - 4. Germany

Q.11 What do you mean by semiconservative DNA replication?

- Ans
- 1. After the completion of replication, each DNA molecule would have two parental and two newly synthesised strand.
  - 2. RNA is dependent on DNA for the synthesis of proteins
  - 3. DNA is dependent on RNA for the synthesis of proteins
  - 4. After the completion of replication, each DNA molecule would have one parental and one newly synthesised strand.

Q.12 The colour of the surface of Mars is red because of the presence of large amounts of chemical compounds in it. What is the name of that compound?

- Ans
- 1. Tin oxide
  - 2. Iron oxide
  - 3. Magnesium oxide
  - 4. Nitrogen oxide

Q.13 In MS-Word, a number printed above the base line is called \_\_\_\_\_.

- Ans
- 1. superscript
  - 2. strikethrough
  - 3. above BL
  - 4. subscript

Q.14 How many censuses had been completed in India as of year 2011?

- Ans
- 1. 12
  - 2. 7
  - 3. 15
  - 4. 16

Q.15 Which of the following statement(s) is/are INCORRECT vis-à-vis features of the Indian Constitution?

- 1) Though India has a federal system, the Constitution does not mention the word 'federation'.
- 2) Article 5 of the Constitution says that the Parliament by law can create a new state.
- 3) On the subjects in the Union list, each State Legislature can enact laws for the State.
- 4) Both the Parliament and State Legislature can pass laws on subjects in concurrent list.

- Ans
- 1. 1 and 4
  - 2. 1 and 3
  - 3. Only 1
  - 4. 2 and 3

Q.16 Under which Gharana do the composition of blend of Khayal and Dhrupad-Dhamar styles come?

- Ans
- 1. Indore Gharana
  - 2. Agra Gharana
  - 3. Gwalior Gharana
  - 4. Patiala Gharana

Q.17 The number of Indian athletes who participated in the Tokyo Paralympics 2020 was \_\_\_\_\_.

- Ans
- 1. 57
  - 2. 56
  - 3. 54
  - 4. 55

Q.18 Which Pala ruler temporarily occupied Kanauj?

- Ans
- 1. Gopala
  - 2. Dharmapala
  - 3. Devapala
  - 4. Harapala

Q.19 According to Census of India 2011, what was the sex ratio recorded in the Union Territory of Puducherry?

- Ans
- 1. 980 females/1000 males
  - 2. 1095 females/1000 males
  - 3. 1037 females/1000 males
  - 4. 890 females/1000 males

Q.20 The Ultimate Kho-Kho League was started in which year?

- Ans
- 1. 2020
  - 2. 2021
  - 3. 2022
  - 4. 2023

Q.21 Indian Constitution came into force on \_\_\_\_\_ and is celebrated as Republic Day.

- Ans
- 1. 26 Jan 1951
  - 2. 26 Jan 1950
  - 3. 26 Jan 1948
  - 4. 26 Feb 1950

Q.22 Who among the following launched the digital platform 'FASTER'?

- Ans
- 1. Chief Justice of India
  - 2. Prime Minister
  - 3. Finance Minister
  - 4. President

Q.23 In field hockey, in a penalty stroke, an attacker shoots at goal from \_\_\_\_\_ yards away in a one-on-one confrontation with the goalkeeper.

- Ans
- 1. 10
  - 2. 8
  - 3. 7
  - 4. 9

Q.24 Who was appointed as the Chief Economic Advisor to the Government of India in the year 2022?

- Ans
- 1. S Somanath
  - 2. Krishnamurthy Subramanian
  - 3. V Anantha Nageswaran
  - 4. R Rangarajan

Q.25 Which river is known as the sorrow of Bihar?

- Ans
- 1. Mahi
  - 2. Betwa
  - 3. Son
  - 4. Kosi

Adda247 Marathi



## Combined Higher Secondary Level Examination 2024 Tier I

Exam Date	03/07/2024
Exam Time	2:30 PM - 3:30 PM
Subject	CHSL Exam 2024 Tier I

### Section : English Language

1. Parts of the following sentence have been given as options. Select the option that contains an error. Today she said to her friend, "You're the sweetest person I have met ever".

Ans  1. I have met ever".  
 2. her friend, "You're  
 3. Today she said to  
 4. the sweetest person

2. The following sentence has been split into four segments. Identify the segment that contains an INCORRECT preposition. Please remember to take / your notice to the reception area / if you want it to be displayed / upon the bulletin board.

Ans  1. Please remember to take  
 2. upon the bulletin board  
 3. if you want it to be displayed  
 4. your notice to the reception area

3. The given sentence is divided into four segments. Select the option that has the segment with a grammatical error. The class / teacher was / wounded in / a leg.

Ans  1. a leg.  
 2. teacher was  
 3. wounded in  
 4. The class

- Q.4 The following sentence has been divided into four segments. Identify the segment that contains a grammatical error.

Don't go / outside / because it is / raining heavy.

Ans  1. Don't go  
 2. outside  
 3. raining heavy.  
 4. because it is

**Comprehension:**

In the following passage, some words have been deleted. Read the passage carefully and select the most appropriate option to fill in each blank.

The tuatara, which lives on New Zealand's islands, is affectionately known as Living fossil. It is called that because it is the only (1)\_\_\_\_\_reptile in a group of reptiles that dates back about 220 million years to the time of the dinosaurs. The colour of the tuatara is grey or olive green. It (2)\_\_\_\_\_to a length of around 60 cm. The fact that this lizard has three eyes is its most (3)\_\_\_\_\_feature. The pineal eye is the name given to the cone-shaped third eye. This eye is in a space between the brain and head. It has an eyelid over the third eye, which closes on a horizontal level. The tuatara has teeth that are (4)\_\_\_\_\_from those of other reptiles. The lower jaw has only one row of teeth, while the upper jaw has two rows.

The tuatara is most active at night. It eats the eggs of birds, frogs, rats and insects. A tuatara's average lifespan is less than 77 years, but some species can live up to 100 years. In the spring, the female tuatara lays 8 to 15 eggs. These eggs are (5)\_\_\_\_\_during summer.

**SubQuestion No : 5**

**Q.5** Select the most appropriate option to fill in blank number 1.

- Ans**
- 1. living
  - 2. being
  - 3. entity
  - 4. life

**Comprehension:**

In the following passage, some words have been deleted. Read the passage carefully and select the most appropriate option to fill in each blank.

The tuatara, which lives on New Zealand's islands, is affectionately known as Living fossil. It is called that because it is the only (1)\_\_\_\_\_reptile in a group of reptiles that dates back about 220 million years to the time of the dinosaurs. The colour of the tuatara is grey or olive green. It (2)\_\_\_\_\_to a length of around 60 cm. The fact that this lizard has three eyes is its most (3)\_\_\_\_\_feature. The pineal eye is the name given to the cone-shaped third eye. This eye is in a space between the brain and head. It has an eyelid over the third eye, which closes on a horizontal level. The tuatara has teeth that are (4)\_\_\_\_\_from those of other reptiles. The lower jaw has only one row of teeth, while the upper jaw has two rows.

The tuatara is most active at night. It eats the eggs of birds, frogs, rats and insects. A tuatara's average lifespan is less than 77 years, but some species can live up to 100 years. In the spring, the female tuatara lays 8 to 15 eggs. These eggs are (5)\_\_\_\_\_during summer.

**SubQuestion No : 6**

**Q.6** Select the most appropriate option to fill in blank number 2.

- Ans**
- 1. creates
  - 2. develops
  - 3. links
  - 4. nourishes

**Comprehension:**

In the following passage, some words have been deleted. Read the passage carefully and select the most appropriate option to fill in each blank.

The tuatara, which lives on New Zealand's islands, is affectionately known as Living fossil. It is called that because it is the only (1)\_\_\_\_\_reptile in a group of reptiles that dates back about 220 million years to the time of the dinosaurs. The colour of the tuatara is grey or olive green. It (2)\_\_\_\_\_to a length of around 60 cm. The fact that this lizard has three eyes is its most (3)\_\_\_\_\_feature. The pineal eye is the name given to the cone-shaped third eye. This eye is in a space between the brain and head. It has an eyelid over the third eye, which closes on a horizontal level. The tuatara has teeth that are (4)\_\_\_\_\_from those of other reptiles. The lower jaw has only one row of teeth, while the upper jaw has two rows.

The tuatara is most active at night. It eats the eggs of birds, frogs, rats and insects. A tuatara's average lifespan is less than 77 years, but some species can live up to 100 years. In the spring, the female tuatara lays 8 to 15 eggs. These eggs are (5)\_\_\_\_\_during summer.

**SubQuestion No : 7**

**Q.7** Select the most appropriate option to fill in blank number 3.

- Ans**
- 1. intriguing
  - 2. absorbing
  - 3. diverting
  - 4. escalating

**Comprehension:**

In the following passage, some words have been deleted. Read the passage carefully and select the most appropriate option to fill in each blank.

The tuatara, which lives on New Zealand's islands, is affectionately known as Living fossil. It is called that because it is the only (1)\_\_\_\_\_reptile in a group of reptiles that dates back about 220 million years to the time of the dinosaurs. The colour of the tuatara is grey or olive green. It (2)\_\_\_\_\_to a length of around 60 cm. The fact that this lizard has three eyes is its most (3)\_\_\_\_\_feature. The pineal eye is the name given to the cone-shaped third eye. This eye is in a space between the brain and head. It has an eyelid over the third eye, which closes on a horizontal level. The tuatara has teeth that are (4)\_\_\_\_\_from those of other reptiles. The lower jaw has only one row of teeth, while the upper jaw has two rows.

The tuatara is most active at night. It eats the eggs of birds, frogs, rats and insects. A tuatara's average lifespan is less than 77 years, but some species can live up to 100 years. In the spring, the female tuatara lays 8 to 15 eggs. These eggs are (5)\_\_\_\_\_during summer.

**SubQuestion No : 8**

**Q.8 Select the most appropriate option to fill in blank number 4.**

- Ans**
- 1. separate
  - 2. distinct
  - 3. discrete
  - 4. sharp

**Comprehension:**

In the following passage, some words have been deleted. Read the passage carefully and select the most appropriate option to fill in each blank.

The tuatara, which lives on New Zealand's islands, is affectionately known as Living fossil. It is called that because it is the only (1)\_\_\_\_\_reptile in a group of reptiles that dates back about 220 million years to the time of the dinosaurs. The colour of the tuatara is grey or olive green. It (2)\_\_\_\_\_to a length of around 60 cm. The fact that this lizard has three eyes is its most (3)\_\_\_\_\_feature. The pineal eye is the name given to the cone-shaped third eye. This eye is in a space between the brain and head. It has an eyelid over the third eye, which closes on a horizontal level. The tuatara has teeth that are (4)\_\_\_\_\_from those of other reptiles. The lower jaw has only one row of teeth, while the upper jaw has two rows.

The tuatara is most active at night. It eats the eggs of birds, frogs, rats and insects. A tuatara's average lifespan is less than 77 years, but some species can live up to 100 years. In the spring, the female tuatara lays 8 to 15 eggs. These eggs are (5)\_\_\_\_\_during summer.

**SubQuestion No : 9**

**Q.9 Select the most appropriate option to fill in blank number 5.**

- Ans**
- 1. pollinated
  - 2. fertilised
  - 3. germinated
  - 4. fructified

**Q.10 Select the most appropriate meaning of the given idiom.**

**Around the clock**

- Ans**
- 1. Something that is done at night
  - 2. Something that is done within one hour
  - 3. Something that is time bound
  - 4. Something that goes on day and night

**Q.11 Select the most appropriate meaning of the given idiom.**  
**Best thing since sliced bread**

- Ans**
- 1. Breaking news
  - 2. Something to be cautious about
  - 3. Extremely good, interesting
  - 4. Rated well amongst cooks

**Q.12 Select the most appropriate synonym of the given word.**

**Ablaze**

- Ans**
- 1. Extinguished
  - 2. Burning
  - 3. Brazen
  - 4. Sharp

Q.13 Select the most appropriate ANTONYM of the underlined word in the given sentence.  
Mr. Stein is a very cold and hard man.

- Ans
- 1. Clement
  - 2. Relaxed
  - 3. Charitable
  - 4. Tolerant

Q.14 Select the most appropriate option to fill in the blank.

Many developing nations are having a \_\_\_\_\_ economy these days.

- Ans
- 1. boosting
  - 2. resounding
  - 3. ringing
  - 4. booming

Q.15 Read the sentence carefully and select the synonym of the underlined word from the given alternatives.

Everyone revered my austere father who was the high priest of the famous Shiva temple.

- Ans
- 1. Stern
  - 2. Composed
  - 3. Morose
  - 4. Aged

Q.16 Select the most appropriate option that can substitute the underlined segment in the given sentence.  
Little that I knew of the English language was not sufficient to make me an English teacher.

- Ans
- 1. So little
  - 2. A little
  - 3. The little
  - 4. Very little

Q.17 Select the most appropriate ANTONYM of the underlined word in the following sentence.  
My most vivid recollection of that summer is the ocean.

- Ans
- 1. Vague
  - 2. Eloquent
  - 3. Pictorial
  - 4. Lucid

Q.18 Select the most appropriate option that can substitute the underlined segment in the given sentence. If there is no need to substitute it, select 'No improvement required'.  
The annual seed festival hosted in Auroville promote sharing of traditional knowledge and sustainable farming practices.

- Ans
- 1. promotes sharing of traditional
  - 2. promotes sharing of traditionally
  - 3. promotes sharing of tradition
  - 4. No improvement required

Q.19 Select the INCORRECTLY spelt word.

- Ans
- 1. Magnanimos
  - 2. Accompanied
  - 3. Fascination
  - 4. Psychology

Q.20 Select the most appropriate ANTONYM of the given word.  
Sacred

- Ans
- 1. Grave
  - 2. Narrow
  - 3. Holy
  - 4. Profane

Q.21 Select the INCORRECTLY spelt word.

- Ans
- 1. Chief
  - 2. Relevant
  - 3. Colleague
  - 4. Judgment

Q.22 Select the most appropriate ANTONYM of the given word.  
Alive

- Ans
- 1. Wise
  - 2. Animated
  - 3. Spry
  - 4. Dead

Q.23 Select the most appropriate ANTONYM of the underlined word in the following sentence.

You should never visit her without her consent.

- Ans
- 1. Approval
  - 2. Permission
  - 3. Knowledge
  - 4. Refusal

Q.24 Select the most appropriate option that can substitute the underlined segment in the given sentence. If there is no need to substitute it, select 'No substitution'.  
He was the fastest between all the contestants.

- Ans
- 1. No substitution
  - 2. since
  - 3. amongst
  - 4. from

Q.25 Select the most appropriate option that can substitute the underlined segment in the given sentence.  
There is no place on the bench.

- Ans
- 1. more space
  - 2. no life
  - 3. more place
  - 4. no room

Section : General Intelligence

1. If 29 December 1956 was a Saturday, then what was the day of the week on 16 January 1967?

- Ans
- 1. Friday
  - 2. Saturday
  - 3. Monday
  - 4. Sunday

Q.2 Select the option figure in which the given figure is embedded as its part (rotation is NOT allowed).



Ans

✗ 1.



✓ 2.



✗ 3.



✗ 4.



Q.3 In a certain code language, 'GCJL' is coded as '14-6-20-24' and 'WTRO' is coded as '46-40-36-30'. What is the code for 'BZKQ' in the given code language?

Ans ✓ 1. 4-52-22-34

✗ 2. 2-52-22-34

✗ 3. 4-52-21-32

✗ 4. 3-51-20-33

Q.4 What will come in the place of the question mark (?) in the following equation, if '+' and '-' are interchanged and '×' and '÷' are interchanged?

$$800 \times 16 - 8 + 12 + 18 = ?$$

Ans ✓ 1. 128

✗ 2. 126

✗ 3. 129

✗ 4. 127

Q.5 What should come in place of ? in the given series?

8, 15, 29, 57, 113 ?

Ans ✗ 1. 222

✓ 2. 225

✗ 3. 223

✗ 4. 224

Q.6 'MANGO' is related to '35' in a certain way based on the English alphabetical order. In the same way, 'CHERRIES' is related to '56'. To which of the following is 'ADMINISTRATION' related, following the same logic?

- Ans
- 1. 112
  - 2. 98
  - 3. 102
  - 4. 96

Q.7 What should come in place of the question mark (?) in the given series based on the English alphabetical order?

FQN, CLL, ZGJ, WBH, ?

- Ans
- 1. SVF
  - 2. TVE
  - 3. SVE
  - 4. TWF

Q.8 Select the correct mirror image of the given figure when the mirror is placed at MN as shown below.

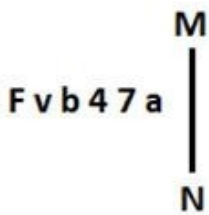

- Ans
- 1. s 7 4 d v f
  - 2. s 7 4 d v f
  - 3. s 7 4 d v f
  - 4. s 7 4 d v f

Q.9 In this question, three statements are given, followed by three conclusions numbered I, II and III. Assuming the statements to be true, even if they seem to be at variance with commonly known facts, decide which of the conclusion(s) logically follows/follow from the statements.

Statements:

All chairs are sofas.

Some chairs are beds.

No sofa is a table.

Conclusions:

I. Some tables are beds.

II. No table is a chair.

III. Some sofas are beds.

- Ans
- 1. Both conclusions I and II follow.
  - 2. All conclusions I, II and III follow.
  - 3. Both conclusions II and III follow.
  - 4. Both conclusions I and III follow.

Q.10 How many rectangles are there in the following figure?



- Ans
- 1. 8
  - 2. 9
  - 3. 10
  - 4. 11

Q.11 If 'A' stands for '+', 'B' stands for '×', 'C' stands for '÷' and 'D' stands for '-', what will come in place of the question mark (?) in the following equation?

$$93 \text{ A } 3 \text{ C } 15 \text{ B } 5 \text{ D } 12 = ?$$

- Ans
- 1. 93
  - 2. 94
  - 3. 91
  - 4. 92

Q.12 765 is related to 876 following a certain logic. Following the same logic, 682 is related to 793.

To which of the following is 587 related, following the same logic?

(NOTE: Operations should be performed on the whole numbers, without breaking down the numbers into its constituent digits. E.g. 13 &ndash; Operations on 13 such as adding/subtracting/multiplying etc. to 13 can be performed. Breaking down 13 into 1 and 3 and then performing mathematical operations on 1 and 3 is not allowed.)

- Ans
- 1. 543
  - 2. 798
  - 3. 675
  - 4. 698

Q.13 What will come in the place of the question mark (?) in the following equation if '+' and '-' are interchanged and '×' and '÷' are interchanged?

$$73 - 27 \times 9 + 5 \div 13 = ?$$

- Ans
- 1. 23
  - 2. 17
  - 3. 11
  - 4. 9

Q.14 What would be the word on the opposite side of 'Run' if the given sheet is folded to form a cube?

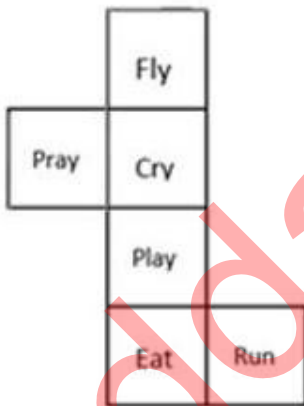

- Ans
- 1. Cry
  - 2. Play
  - 3. Fly
  - 4. Pray



Q.15 What should come in place of ? in the given series based on the English alphabetical order?

QJC ATM KDW UNG ?

- Ans
- 1. SBA
  - 2. BAA
  - 3. CWO
  - 4. EXQ

Q.16 Identify the figure given in the options which when put in place of ? will logically complete the series.

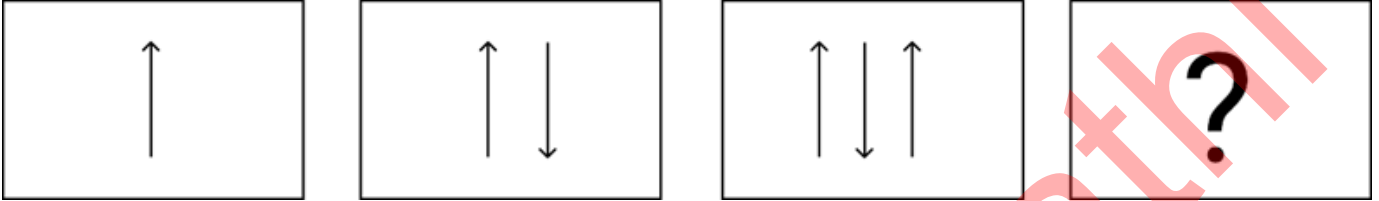

Ans

- 1. 

A box containing four arrows: two pointing up and two pointing down.
- 2. 

A box containing four arrows, all pointing up.
- 3. 

A box containing four arrows: the first and third point up, the second and fourth point down.
- 4. 

A box containing four arrows: the first and third point down, the second and fourth point up.

Q.17 In a certain code language, 'time and money' is coded as 'zoo zee zig' and 'time and tide' is coded as 'zee zoo zaa'. Which word is coded as 'zaa' in that language?

- Ans
- 1. and
  - 2. time
  - 3. money
  - 4. tide

Q.18 What should come in place of '?' in the given series?

34 58 106 202 394 ?

- Ans
- 1. 778
  - 2. 792
  - 3. 798
  - 4. 774

Q.19 PCNZ is related to ALWQ in a certain way based on the English alphabetical order. In the same way, RYLD is related to EHUS. To which of the following is HAXM related, following the same logic?

- Ans
- 1. NJGI
  - 2. NIGJ
  - 3. NIJG
  - 4. NJIG

Q.20 'A + B' means 'A is B's brother'.  
'A - B' means 'A is B's wife'.  
'A × B' means 'A is B's father'.  
'A ÷ B' means 'A is B's daughter'.

Using operations with the same meaning as given above, which of the following options shows 'M is the mother of O'?

- Ans
- 1.  $M - N \times O$
  - 2.  $M \div N \times O$
  - 3.  $M \div N + O$
  - 4.  $M - N + O$

Q.21 What would be the word on the opposite side of 'Pear' if the given sheet is folded to form a cube?



- Ans
- 1. Melon
  - 2. Kiwi
  - 3. Lime
  - 4. Mango

Q.22 Select the set in which the numbers are related in the same way as are the numbers of the following sets.  
(NOTE: Operations should be performed on the whole numbers, without breaking down the numbers into their constituent digits. E.g. 13 - Operations on 13 such as adding/subtracting/multiplying etc. to 13 can be performed. Breaking down 13 into 1 and 3 and then performing mathematical operations on 1 and 3 is not allowed.)  
(45, 15, 3)  
(120, 40, 8)

- Ans
- 1. (175, 55, 11)
  - 2. (165, 55, 9)
  - 3. (165, 55, 11)
  - 4. (165, 54, 11)

Q.23 Three of the following four are alike in a certain way and thus form a group. Which is the one that does NOT belong to that group?

(Note: The odd one out is not based on the number of consonants/vowels or their position in the letter cluster.)

- Ans
- 1. QWD
  - 2. EKR
  - 3. RXE
  - 4. TZD

Q.24 A paper is folded and cut as shown below. How will it appear when unfolded?

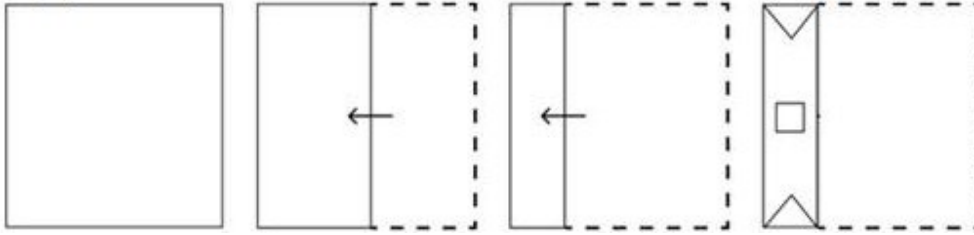

Ans

- 1.
- 2.
- 3.
- 4.

Q.25 If 26 September 2005 was Monday, then what was the day of the week on 26 September 2017?

- Ans
- 1. Saturday
  - 2. Wednesday
  - 3. Sunday
  - 4. Tuesday

Q.1 Simplify the given expression.

$$8 - 5 \div 2^3 \times 3 + (7 \div 7 \times 7) \div 7 + (3 \times 6 \div \frac{1}{3}) \times \frac{1}{3^3}$$

- Ans
- 1.  $\frac{73}{9}$
  - 2.  $\frac{73}{21}$
  - 3.  $\frac{73}{27}$
  - 4.  $\frac{73}{8}$

Q.2 The following table represents the number of computers (in thousands) manufactured by four companies during the period 2010 to 2014:

Years	A	B	C	D
2010	240	120	270	280
2011	300	530	490	650
2012	1250	650	430	710
2013	470	320	1180	890
2014	320	1070	550	480

Which company has the minimum average (in thousands) of manufacturing the computers from 2010 to 2014?

- Ans
- 1. B
  - 2. A
  - 3. C
  - 4. D

Q.3 For a given circle of radius 4 cm, the angle of its sector is  $45^\circ$ . Find the area (in  $\text{cm}^2$ ) of the sector. (Use  $\pi = 3.14$ .)

- Ans
- 1. 6.18
  - 2. 7.28
  - 3. 6.28
  - 4. 7.18

Q.4 In an election between two candidates, 10% of the registered voters did not cast their vote. The winning candidate got 60% of the total votes cast and defeated the other candidate by 1242 votes. Find the total number of registered voters.

- Ans
- 1. 9600
  - 2. 6200
  - 3. 8640
  - 4. 6900

Q.5 If the average of 50 numbers  $N_1, N_2, \dots, N_{50}$  is M. Then the average of the numbers  $N_1-100, N_2-100, \dots, N_{50}-100$  will be:

- Ans
- 1. 100M
  - 2.  $M - 50$
  - 3. 50M
  - 4.  $M - 100$

Q.6 In an 800 m race, the ratio of the speeds of two contestants Ankur and Neha is 5 : 6. If Ankur has a head-start of 200 m, then Ankur will win by \_\_\_\_\_.

- Ans
- 1. 89 m
  - 2. 80 m
  - 3. 76 m
  - 4. 69 m

Q.7 Solve the following system of linear equations:

$$x + y + z = 15, 2x - y + z = 12 \text{ and } x - y - z = -1$$

- Ans
- 1.  $x = 7, y = 5, z = 3$
  - 2.  $x = 2, y = 5, z = 3$
  - 3.  $x = 7, y = 2, z = 3$
  - 4.  $x = 7, y = 5, z = 1$

Q.8 A seven-digit number 489y5z6 is divisible by 72. Which of the options gives the highest possible product of y and

- z? Ans
- 1. 21
  - 2. 30
  - 3. 42
  - 4. 3

Q.9 If the income of P is 40% less than Q, then the combined income of P and Q is how much per cent more than the income of P?

- Ans
- 1.  $164\frac{1}{3}$
  - 2.  $166\frac{1}{3}$
  - 3.  $166\frac{2}{3}$
  - 4.  $164\frac{2}{3}$

Q.10

The following graph shows the sale of few items of a garment company for three months.



What is the percentage of the sale of the least selling item in the three months over the total sale of the company?

- Ans
- ✓ 1. 16%
  - ✗ 2. 25%
  - ✗ 3. 20%
  - ✗ 4. 28%

Q.11 If the height of a right circular cone is 24 cm and radius of its base is 10.5 cm, then the volume of right circular cone (in  $\text{cm}^3$ ) is:

Take  $\pi = \frac{22}{7}$

- Ans
- ✓ 1. 2772
  - ✗ 2. 2727
  - ✗ 3. 2237
  - ✗ 4. 2277

Q.12

The given pie-diagram shows the expenditure incurred on the preparation of a book by a publisher, under various heads. Study the pie-diagram and answer the question that follows.

■ A-Paper ■ B-Printing ■ C-Binding ■ D-Royalty ■ E-Miscellaneous

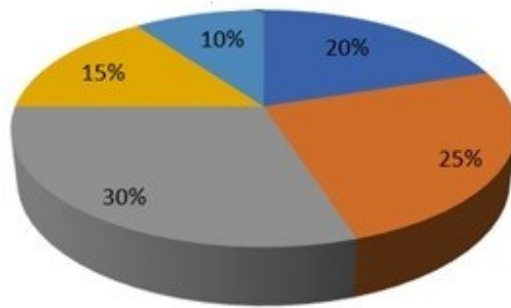

Various Expenditures (in percentage) incurred in Publishing a Book

What is the angle of the pie-diagram showing the expenditure incurred on paying royalty?

- Ans
- 1.  $15^\circ$
  - 2.  $48^\circ$
  - 3.  $54^\circ$
  - 4.  $24^\circ$

Q.13 By selling 30 metres of cloth a shopkeeper makes a profit equivalent to the selling price of 10 metres of cloth. Find the selling price of 1 metre of cloth when the cost price of 1 metre of cloth is ₹480.

- Ans
- 1. ₹520
  - 2. ₹720
  - 3. ₹960
  - 4. ₹820

Q.14 If 6,18, x are sides of a triangle and x is an integer, then the number of possible values of x is:

- Ans
- 1. 11
  - 2. 15
  - 3. 13
  - 4. 14

Q.15 An amount of ₹50,000 becomes ₹72,000 in 4 years on a simple rate of interest. The rate of interest is \_\_\_\_\_ per annum.

- Ans
- 1. 9%
  - 2. 10%
  - 3. 11%
  - 4. 12%

Q.16 A dealer buys an article listed at ₹100 and get successive discounts of 10% and 20%. He spends 10% of the cost price on transportation. At what price should he sell the article to earn a profit of 15%?

- Ans
- 1. ₹76.07
  - 2. ₹81.07
  - 3. ₹89.08
  - 4. ₹91.08

Q.17 A and B can complete a piece of work in 12 days. B and C can complete the same work in 15 days and C and A in 10 days. How many days will A take to complete the work by himself?

Ans

✗ 1.  $16\frac{1}{7}$

✓ 2.  $17\frac{1}{7}$

✗ 3.  $13\frac{3}{7}$

✗ 4.  $9\frac{1}{8}$

Q.18 Answer the following question on the basis of the bar graph given.

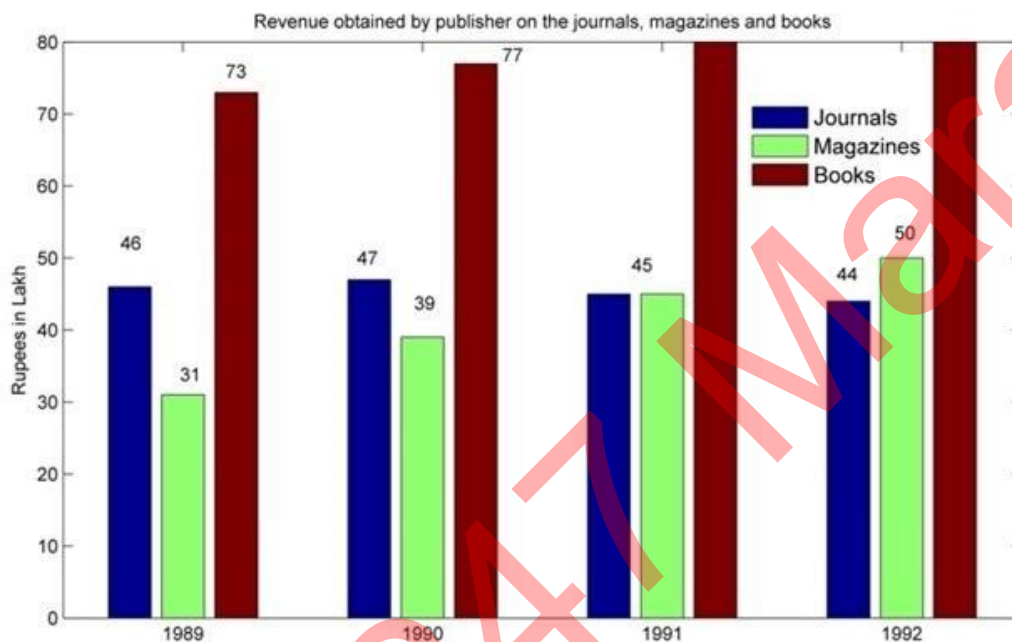

In 1991, what percentage of the total revenue came from journals? (Correct up to one decimal place)

Ans

✗ 1. 24.73%

✗ 2. 25.8%

✗ 3. 22.9%

✓ 4. 26.5%

Q.19 If the perimeter of a square is 64 cm, what would be its area?

Ans

✓ 1.  $256 \text{ cm}^2$

✗ 2.  $206 \text{ cm}^2$

✗ 3.  $216 \text{ cm}^2$

✗ 4.  $266 \text{ cm}^2$



Q.20

Which is the greatest ratio among the following?

$\frac{8}{11}, \frac{4}{5}, \frac{1}{2}$  and  $\frac{1}{11}$

Ans

1.  $\frac{4}{5}$

2.  $\frac{1}{2}$

3.  $\frac{1}{11}$

4.  $\frac{8}{11}$

Q.21 12.75% is equivalent to \_\_\_\_\_.

Ans

1.  $\frac{37}{400}$

2.  $\frac{51}{400}$

3.  $\frac{41}{400}$

4.  $\frac{17}{200}$

Q.22 AB and AC are two tangents to a circle having centres at the point X. What will be the measure of  $\angle BAC$ , if  $\angle BXC = 125^\circ$ ?

Ans

1.  $50^\circ$

2.  $48^\circ$

3.  $55^\circ$

4.  $52^\circ$

Q.23 PQ is parallel to SR in a trapezium PQRS. It is given that  $PQ > SR$  and the diagonals PR and QS intersect at O. If  $PO = 3x - 15$ ,  $OQ = x + 9$ ,  $OR = x - 5$  and  $OS = 5$  and x has two values  $x_1$  and  $x_2$ , then the value of  $(x_1^2 - x_2^2)$  is:

Ans

1. 15

2. 11

3. 19

4. 13

Q.24 If the radius of a sphere is increased by 12 percent, then the volume will be increased by approximately:

Ans

1. 42.5 percent

2. 45.49 percent

3. 40.49 percent

4. 41.49 percent

Q.25  $\frac{3 \cos^3 \theta - 2 \cos \theta}{\sin \theta - 3 \sin^3 \theta}$  is equal to:

- Ans
- 1.  $\tan \theta$
  - 2.  $\cot^2 \theta$
  - 3.  $\cot \theta$
  - 4.  $\tan^2 \theta$

Section : General Awareness

1. The Maritime Anti-Piracy Act, 2022, received the assent of the President on \_\_\_\_\_.

- Ans
- 1. 31 March 2023
  - 2. 30 April 2023
  - 3. 31 December 2022
  - 4. 31 January 2023

2. Where was India's first hockey club founded?

- Ans
- 1. Madras
  - 2. Delhi
  - 3. Calcutta
  - 4. Shimla

3. For which discovery did Henri Becquerel receive the Nobel Prize in Physics in 1903?

- Ans
- 1. Spontaneous Radioactivity
  - 2. Radioactive Elements
  - 3. Radium Emanation
  - 4. Diagnostic Radiography

Q.4 As per the Census-2011, the population growth during the decade remained \_\_\_\_\_.

- Ans
- 1. 15.30%
  - 2. 14.25%
  - 3. 17.64%
  - 4. 18.30%

Q.5 Which of the following is the default alignment of text in a Microsoft Word document?

- Ans
- 1. Center
  - 2. Left
  - 3. Justified
  - 4. Right

Q.6 The term 'banana kick' is associated with which sport?

- Ans
- 1. Ice Hockey
  - 2. Boxing
  - 3. Hockey
  - 4. Football

Q.7 Ursa Major is a/an:

- Ans
- 1. comet
  - 2. asteroid
  - 3. constellation
  - 4. stellite

Q.8 The Deccan Plateau is a \_\_\_\_\_ landmass that lies to the south of the river Narmada.

- Ans
- 1. quadrilateral
  - 2. rectangular
  - 3. hexagonal
  - 4. triangular

Q.9 In which state is the Raika tribe found?

- Ans
- 1. West Bengal
  - 2. Rajasthan
  - 3. Kerala
  - 4. Manipur

Q.10 Where did the indigenous sport 'Kalaripayattu' originate from?

- Ans
- 1. Kerala
  - 2. Karnataka
  - 3. Goa
  - 4. Tamil Nadu

Q.11 \_\_\_\_\_ is a form of Sikh festival.

- Ans
- 1. Khamaj
  - 2. Hola Mohalla
  - 3. Bhairav
  - 4. Kalyan

Q.12 Which of the following statements about the Pala Dynasty of eastern India is INCORRECT?

- Ans
- 1. The Pala dynasty was founded by Gopala.
  - 2. Dharmapala founded the Valabhi university.
  - 3. The Pala kings were the followers of Buddhism.
  - 4. Devapala was the grandson of Gopala.

Q.13 In January 2022, which evacuation mission did the government of India launch to evacuate the Indians stranded in Ukraine?

- Ans
- 1. Operation Ganga
  - 2. Operation Safe Homecoming
  - 3. Operation Vande Bharat
  - 4. Operation Raahat

Q.14 Who developed the technique of preserving the quality of food by raising its temperature to prevent microbial growth in the food?

- Ans
- 1. Robert Koch
  - 2. Antonie van Leeuwenhoek
  - 3. Louis Pasteur
  - 4. Joseph Lister

Q.15 Which Section of the Representation of People's Act (RPA), 1951 deprives the prisoners of their right to vote?

- Ans
- 1. Section 62 (5)
  - 2. Section 15 (3)
  - 3. Section 72 (5)
  - 4. Section 10 (4)

Q.16 The government of which state started the Tansen Samman?

- Ans
- 1. Himachal Pradesh
  - 2. Uttar Pradesh
  - 3. Madhya Pradesh
  - 4. Arunachal Pradesh

Q.17 Which city is referred to as the 'Manchester of India'?

- Ans
- 1. Ahmedabad
  - 2. Kanpur
  - 3. Kolkata
  - 4. Mumbai

Q.18 Which Article of the Constitution mentions about establishing and maintaining institutions for religious and charitable purposes?

- Ans
- 1. Article 28
  - 2. Article 26
  - 3. Article 29
  - 4. Article 30

Q.19 Good Friday is related to:

- Ans
- 1. Christianity
  - 2. Hinduism
  - 3. Sikhism
  - 4. Jainism

Q.20 The proclamation of which Act by the King of England in 1773 paved the way for the establishment of the Supreme Court at Calcutta?

- Ans
- 1. Pitt's India Act
  - 2. Indian Councils Act
  - 3. Charter Act
  - 4. Regulating Act

Q.21 Which of the following folk music of Chhattisgarh is based on the epic Mahabharata?

- Ans
- 1. Paani Haari
  - 2. Ghumar
  - 3. Pandavani
  - 4. Maand

Q.22 Which of the following is issued by commercial banks at a discount on face value?

- Ans
- 1. Commercial papers
  - 2. Certificates of deposits
  - 3. Treasury bills
  - 4. Promissory notes

**Q.23** In a situation wherein A (female) and B (male) are working in same office, same designation, same nature of work but unequal payment, which of the following Articles of the Constitution will be applicable?

- Ans**
- 1. Article 21
  - 2. Article 39(d)
  - 3. Article 18
  - 4. Article 48A

**Q.24** Which of the following is an example of application software?

- Ans**
- 1. A web browser
  - 2. A programming language
  - 3. An operating system
  - 4. A word processor

**Q.25** The Green Revolution led to an increase in the agricultural output primarily due to the use of HYV seeds. Here, HYV refers to:

- Ans**
- 1. High Yielding Variance
  - 2. Heat Yielding Variant
  - 3. High Yielding Variety
  - 4. High Yield Variant

Adda247 Marathi

## Combined Higher Secondary Level Examination 2024 Tier I

Exam Date	03/07/2024
Exam Time	5:15 PM - 6:15 PM
Subject	CHSL Exam 2024 Tier I

### Section : English Language

1. The following sentence has been split into four segments. Identify the segment that contains an error. I had seen / her with her mother / in the cinema hall / yesterday.

- Ans
- 1. in the cinema hall
  - 2. her with her mother
  - 3. yesterday
  - 4. I had seen

2. Select the option to replace the incorrect word in the following sentence. Chotu is a bright young child, who yearn to go to school but works in his uncle's dhaba.

- Ans
- 1. worked
  - 2. working
  - 3. yearns
  - 4. yearned

3. Select the most appropriate option to fill in the blank. He \_\_\_\_\_ a long distance

- Ans
- 1. runned
  - 2. running
  - 3. ran
  - 4. run

Q.4 The following sentence has been divided into three segments. One of them may contain an adverbial usage error. Select the option that has the segment with the error. If you don't find any error, select 'No error' as your answer. Mr. Narayanan / is a rather / lazy man.

- Ans
- 1. No error
  - 2. Mr. Narayanan
  - 3. is a rather
  - 4. lazy man.

**Comprehension:**

In the following passage some words have been deleted. Read the passage carefully and select the most appropriate option to fill in each blank.

Trees are (1) \_\_\_\_\_ best gift of nature for us. They make the environment beautiful and clean. Water and sunlight are very important to helping trees grow. Human beings get food from trees. Trees also give us wood and shade. Houses, chairs, and toys (2) \_\_\_\_\_ from wood we receive from trees. Trees can be called the best friends of mankind. Many animals get their food from leaves, vegetables, and fruits grown (3) \_\_\_\_\_ trees. They also live in the shadows of trees. We (4) \_\_\_\_\_ cutting trees to save nature. Children and adults need to plant more trees and teach each other to stop causing harm to (5) \_\_\_\_\_. One tree can save many lives.

**SubQuestion No : 5**

**Q.5** Select the most appropriate option to fill in blank number 1.

- Ans**
- 1. the
  - 2. a
  - 3. an
  - 4. No article

**Comprehension:**

In the following passage some words have been deleted. Read the passage carefully and select the most appropriate option to fill in each blank.

Trees are (1) \_\_\_\_\_ best gift of nature for us. They make the environment beautiful and clean. Water and sunlight are very important to helping trees grow. Human beings get food from trees. Trees also give us wood and shade. Houses, chairs, and toys (2) \_\_\_\_\_ from wood we receive from trees. Trees can be called the best friends of mankind. Many animals get their food from leaves, vegetables, and fruits grown (3) \_\_\_\_\_ trees. They also live in the shadows of trees. We (4) \_\_\_\_\_ cutting trees to save nature. Children and adults need to plant more trees and teach each other to stop causing harm to (5) \_\_\_\_\_. One tree can save many lives.

**SubQuestion No : 6**

**Q.6** Select the most appropriate option to fill in blank number 2.

- Ans**
- 1. are made
  - 2. had make
  - 3. was make
  - 4. will made

**Comprehension:**

In the following passage some words have been deleted. Read the passage carefully and select the most appropriate option to fill in each blank.

Trees are (1) \_\_\_\_\_ best gift of nature for us. They make the environment beautiful and clean. Water and sunlight are very important to helping trees grow. Human beings get food from trees. Trees also give us wood and shade. Houses, chairs, and toys (2) \_\_\_\_\_ from wood we receive from trees. Trees can be called the best friends of mankind. Many animals get their food from leaves, vegetables, and fruits grown (3) \_\_\_\_\_ trees. They also live in the shadows of trees. We (4) \_\_\_\_\_ cutting trees to save nature. Children and adults need to plant more trees and teach each other to stop causing harm to (5) \_\_\_\_\_. One tree can save many lives.

**SubQuestion No : 7**

**Q.7** Select the most appropriate option to fill in blank number 3.

- Ans**
- 1. on
  - 2. out
  - 3. of
  - 4. for

**Comprehension:**

In the following passage some words have been deleted. Read the passage carefully and select the most appropriate option to fill in each blank.

Trees are (1) \_\_\_\_\_ best gift of nature for us. They make the environment beautiful and clean. Water and sunlight are very important to helping trees grow. Human beings get food from trees. Trees also give us wood and shade. Houses, chairs, and toys (2) \_\_\_\_\_ from wood we receive from trees. Trees can be called the best friends of mankind. Many animals get their food from leaves, vegetables, and fruits grown (3) \_\_\_\_\_ trees. They also live in the shadows of trees. We (4) \_\_\_\_\_ cutting trees to save nature. Children and adults need to plant more trees and teach each other to stop causing harm to (5) \_\_\_\_\_. One tree can save many lives.

**SubQuestion No : 8**

**Q.8** Select the most appropriate option to fill in blank number 4.

- Ans**
- 1. can stopped
  - 2. may stopped
  - 3. should stop
  - 4. have stop

**Comprehension:**

In the following passage some words have been deleted. Read the passage carefully and select the most appropriate option to fill in each blank.

Trees are (1) \_\_\_\_\_ best gift of nature for us. They make the environment beautiful and clean. Water and sunlight are very important to helping trees grow. Human beings get food from trees. Trees also give us wood and shade. Houses, chairs, and toys (2) \_\_\_\_\_ from wood we receive from trees. Trees can be called the best friends of mankind. Many animals get their food from leaves, vegetables, and fruits grown (3) \_\_\_\_\_ trees. They also live in the shadows of trees. We (4) \_\_\_\_\_ cutting trees to save nature. Children and adults need to plant more trees and teach each other to stop causing harm to (5) \_\_\_\_\_. One tree can save many lives.

**SubQuestion No : 9**

**Q.9** Select the most appropriate option to fill in blank number 5.

- Ans**
- 1. nurturing
  - 2. nature
  - 3. nurture
  - 4. natural

**Q.10** Select the most appropriate to fill in the blank.  
The boxer was knocked out cold by a powerful \_\_\_\_\_ punch to the jaw.

- Ans**
- 1. write
  - 2. wright
  - 3. rite
  - 4. right

**Q.11** Select the option that can substitute the bracketed word segment meaningfully.  
If you behave well and exhibit good manners, then (people will be likely to remember you) in a positive way.

- Ans**
- 1. people likely you remember
  - 2. people are like remember you
  - 3. people will like in remember
  - 4. people are likely to remember you

**Q.12** Select the most appropriate idiom that can substitute the underlined word segment in the given sentence.  
Delivering that furniture to the tenth floor without the lift and an incline is incredibly foolish and next to impossible

- Ans**
- 1. like a tree known by its fruits
  - 2. like nailing jelly to the tree
  - 3. as tight as the bark of the tree
  - 4. like going between the bark and the tree



Q.13 Select the most appropriate ANTONYM of the underlined word in the given sentence.  
This makes readers contemplate the motives people have for performing acts of charity.

- Ans
- 1. understate
  - 2. follow up
  - 3. overlook
  - 4. deviate

Q.14 The following sentence has been split into four segments. Identify the segment that contains a spelling error. In all instances of frustrasion, / you will always find / the anger directed towards / a single person only.

- Ans
- 1. the anger directed towards
  - 2. In all instances of frustrasion
  - 3. you will always find
  - 4. a single person only

Q.15 Select the most appropriate option to fill in the blank.

The movie 'Desperate Ghosts' was watched by my younger brother and he was \_\_\_\_\_ horror.

- Ans
- 1. filled with
  - 2. filled of
  - 3. filled on
  - 4. filled off

Q.16 Read the sentence carefully and select the most appropriate option to substitute the underlined part.

The sudden declaration of war between two countries led to a disarray.

- Ans
- 1. peaceful treaty
  - 2. disorderly situation
  - 3. refined argument
  - 4. elusive situation

Q.17 Select the INCORRECTLY spelt word.

- Ans
- 1. Acknowledgment
  - 2. Apparent
  - 3. Fulfil
  - 4. Conscientious

Q.18 Select the most appropriate idiom to fill in the blank.

This gun should be handled with care and \_\_\_\_\_.

- Ans
- 1. nip in the bud
  - 2. shot for safety
  - 3. mince the matters
  - 4. kept at arm's length

Q.19 Select the most appropriate synonym of the word 'echoed' to fill in the blank.  
The thunderous applause \_\_\_\_\_ through the stadium.

- Ans
- 1. reverberated
  - 2. recoiled
  - 3. bounced
  - 4. pulsed

Q.20 Select the most appropriate synonym of the given word.

Chaste

- Ans
- 1. Flashy
  - 2. Corrupt
  - 3. Sullied
  - 4. Pure

Q.21 Select the most appropriate ANTONYM of the given word.  
Cheerful

- Ans
- 1. Sunny
  - 2. Hilarious
  - 3. Gloomy
  - 4. Joyful

Q.22 Select the most appropriate ANTONYM of the underlined word in the sentence.  
He tried to improve the working conditions in his office.

- Ans
- 1. Spatter
  - 2. Sprinkle
  - 3. Specify
  - 4. Spoil

Q.23 Select the most appropriate option that can substitute the underlined segment in the given sentence.  
It was her who first saw the criminal.

- Ans
- 1. she
  - 2. them
  - 3. hers
  - 4. him

Q.24 Select the most appropriate synonym of the underlined word in the given sentence.

Can I please request you all to stand up?

- Ans
- 1. require
  - 2. plead
  - 3. claim
  - 4. petition

Q.25 Read the sentence carefully and select the most appropriate option to substitute the underlined part.

Greta Thunberg's tirade against environmental degeneration shocked the world leaders.

- Ans
- 1. minute observation
  - 2. debatable account
  - 3. long and angry speech
  - 4. innate liberal opinion

Section : General Intelligence

1. What should come in place of the question mark (?) in the given series based on the English alphabetical order?

BOJ, FQO, JST, NUY, ?

- Ans
- 1. RVB
  - 2. QWD
  - 3. QVC
  - 4. RWD

2. 'P + F' means 'P is the son of F'  
 'P - F' means 'P is the wife of F'  
 'P × F' means 'P is the brother of F'  
 'P ÷ F' means 'P is the mother of F'  
 'P = F' means 'P is the sister of F'.  
 What does 'K = R ÷ M' mean?

- Ans
- 1. K is the daughter of M
  - 2. K is the aunt (mother's sister) of M
  - 3. K is the sister of M
  - 4. K is the niece of M

Q.3 A paper is folded and cut as shown below. How will it appear when unfolded?

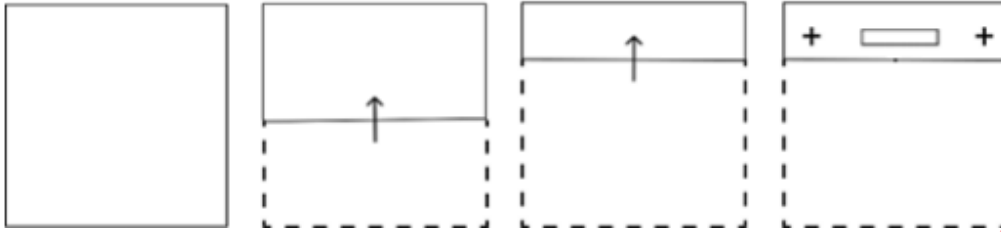

Ans

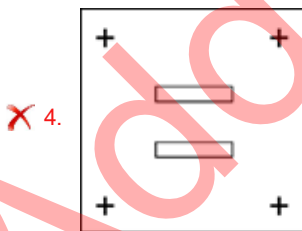
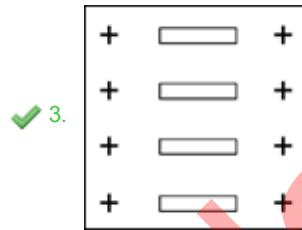
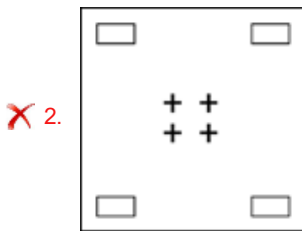
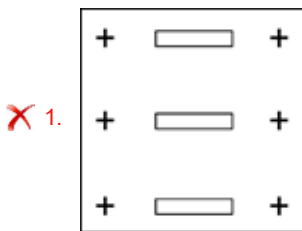

Q.4 In a certain code language, 'BABE' is coded as '20' and 'EACH' is coded as '34'. What is the code for 'FACT' in the given code language?

- Ans
- 1. 63
  - 2. 62
  - 3. 64
  - 4. 60

Q.5 129 is related to 387 following a certain logic. Following the same logic, 164 is related to 492. To which of the following is 148 related, following the same logic?

- Ans
- 1. 444
  - 2. 468
  - 3. 352
  - 4. 362

Q.6 If 'R' stands for '+', 'K' stands for '×', 'G' stands for '+' and 'D' stands for '-', what will come in place of the question mark (?) in the following equation?  
32 G 15 R 15D 17 K 18 = ?

- Ans
- 1. -456
  - 2. -273
  - 3. -879
  - 4. -235

Q.7 Which of the following numbers will replace the question mark (?) in the given series?  
244 232.1 220.2 208.3 196.4 ?

- Ans
- 1. 176.5
  - 2. 172.5
  - 3. 180.5
  - 4. 184.5

Q.8 What will come in the place of the question mark (?) in the following equation, if '+' and '-' are interchanged and '×' and '÷' are interchanged?

$$59 + 39 - 63 \times 21 \div 26 = ?$$

- Ans
- 1. 98
  - 2. 96
  - 3. 90
  - 4. 93

Q.9 Identify the figure given in the options that when put in place of the question mark (?) will logically complete the series.

E	☆	2	E	
N	2	☆	T	
☆ 2 T	T N E	E T N	N ☆ 2	?

Ans

✗ 1.

N		
	☆	
2	T	E

✗ 2.

E		
	N	
☆	2	T

✗ 3.

T		
	2	
☆	N	E

✓ 4.

T		
	E	
2	N	☆

Q.10 In a certain language,  
 A & B means A is the wife of B,  
 A ÷ B means A is the mother of B,  
 A × B means A is the son of B,  
 A + B means A is the sister of B and  
 A @ B means A is the father of B.  
 If A @ B & C @ D + K ÷ F, how is C related to K?

Ans

✗ 1. Mother

✓ 2. Father

✗ 3. Sister

✗ 4. Brother

**Q.11** In this question, three statements are given, followed by three conclusions numbered I, II and III. Assuming the statements to be true, even if they seem to be at variance with commonly known facts, decide which of the conclusion(s) logically follows/follow from the statements.

**Statements:**

Some carrots are onions.

All onions are potatoes.

All potatoes are radish.

**Conclusions:**

I. Some carrots are radish.

II. All onions are radish.

III. No carrot is a potato.

**Ans**  1. Only conclusion II follows.

2. Only conclusion I follows.

3. Both conclusions I and II follow.

4. Only conclusion III follows.

Adda247 Marathi

Q.12 Select the correct mirror image of the given figure when the mirror is placed at MN as shown below.

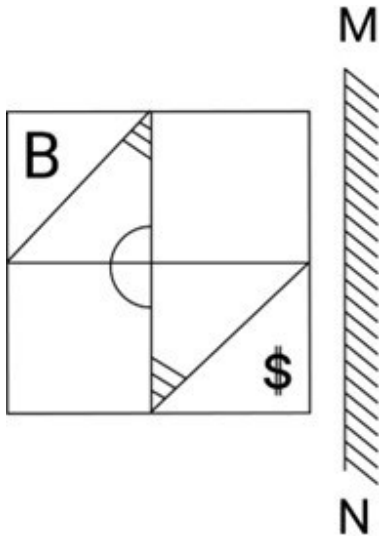

Ans

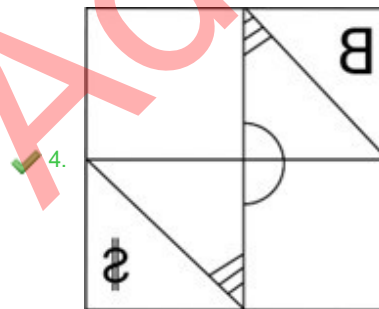
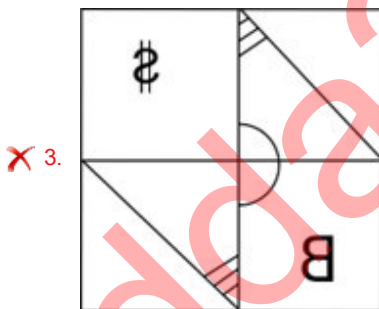
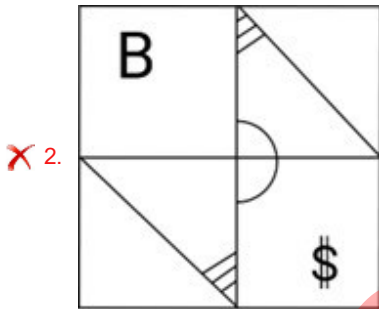
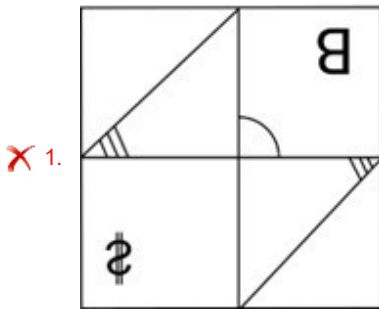

Q.13 In a certain code language, 'RISK' is coded as '3921' and 'KIRT' is coded as '1693'. How is 'S' coded in the given language?

- Ans
- 1. 2
  - 2. 3
  - 3. 1
  - 4. 6

Q.14 If 10 October 2003 was a Friday, then what was the day of the week on 8 October 2015?

- Ans
- 1. Thursday
  - 2. Tuesday
  - 3. Friday
  - 4. Monday

Q.15 What will come in the place of the question mark (?) in the following equation, if '+' and '-' are interchanged and '×' and '÷' are interchanged?

$$105 \div 2 + 4 - 120 \times 6 = ?$$

- Ans
- 1. 266
  - 2. 126
  - 3. 216
  - 4. 226

Q.16 Select the correct mirror image of the given combination when the mirror is placed at MN as shown below.

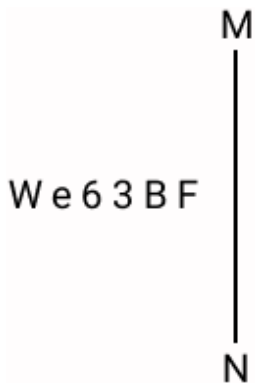

- Ans
- 1. W e 6 3 B F
  - 2. B F 3 6 e W
  - 3. W e 6 3 B F
  - 4. W e 6 3 B F



Q.17 Select the option figure in which the given figure is embedded as its part (rotation is NOT allowed).



Ans

1.

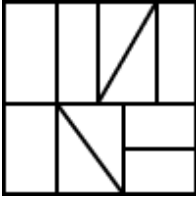

2.



3.

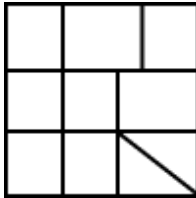

4.

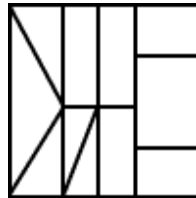

Q.18 Select the correct mirror image of the given combination when the mirror is placed at MN as shown below.

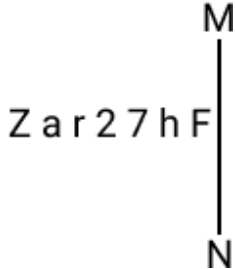

Ans

1.

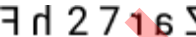

2.



3.



4.



Q.19 Select the set in which the numbers are related in the same way as are the numbers of the following sets.  
 (NOTE: Operations should be performed on the whole numbers, without breaking down the numbers into its constituent digits. E.g., 13 – Operations on 13 such as adding /deleting /multiplying etc. to 13 can be performed. Breaking down 13 into 1 and 3 and then performing mathematical operations on 1 and 3 is not allowed.)

(4, 16, 32)

(7, 49, 98)

Ans

1.

(12, 144, 288)

2.

(12, 144, 278)

3.

(12, 134, 288)

4.

(14, 144, 288)

Q.20 This question consists of a pair of words which have a certain relationship to each other. Select the pair which does NOT have the same relationship.

Allure : Repulse

- 1) Creation : Destruction
- 2) Fluctuate : Stabilize
- 3) Immense : Huge
- 4) Notion : Reality

Ans  1. 4

2. 3

3. 1

4. 2

Q.21 What should come in place of the question mark (?) in the given series based on the English alphabetical order?  
WYS, BDX, GIC, LNH, ?

Ans  1. QSM

2. QMS

3. SMQ

4. PSM

Q.22 What should come in place of X in the given series?

3 9 21 41 71 X

Ans  1. 110

2. 117

3. 113

4. 120

Q.23 How many triangles are there in the given figure?

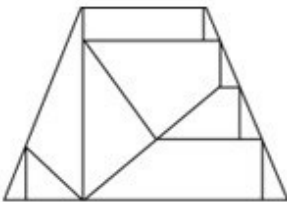

Ans  1. 10

2. 11

3. 9

4. 12

Q.24 ADFI is related to CFHK in a certain way based on the English alphabetical order. In the same way, EHJM is related to GJLO. To which of the following is ILNQ related to, following the same logic?

Ans  1. KMPS

2. KNQT

3. KNQS

4. KNPS

Q.25 If 19 July 2000 is Wednesday, then what will be the day of the week on 17 March 2015?

Ans  1. Wednesday

2. Friday

3. Tuesday

4. Sunday

**Q.1** In an engineering college, there are four branches namely Computer Science (CS), Electronics (EC), Civil (CE), and Mechanical (ME). The respective ratio of the number of students in these branches is 11 : 5 : 6 : 7. What is the percentage of students belonging to CS and ME branches in the college (correct up to two decimal places)?

- Ans**
- 1. 61.07%
  - 2. 61.37%
  - 3. 62.07%
  - 4. 62.37%

**Q.2** If the perimeters of two similar triangles are in the ratio of 4 : 7, and the sum of the areas is  $195 \text{ cm}^2$ , then what is  $\frac{1}{3}$  of the difference between the areas (in  $\text{cm}^2$ ) of the two triangles?

- Ans**
- 1. 33
  - 2. 54
  - 3. 99
  - 4. 63

**Q.3** Riya and Sangeeta can finish a work in 6 days and 8 days, respectively. Riya started the work alone and then after 3 days, Sangeeta joined Riya. They both finish the remaining work. How long did the total work last?

- Ans**
- 1.  $4\frac{3}{7}$  days
  - 2.  $4\frac{5}{7}$  days
  - 3.  $4\frac{2}{7}$  days
  - 4.  $4\frac{4}{7}$  days

**Q.4** Four cubes each of volume 216 cubic cm are joined end to end to form a new solid. The surface area of the new solid is:

- Ans**
- 1. 1296 sq cm
  - 2. 648 sq cm
  - 3. 672 sq cm
  - 4. 324 sq cm

**Q.5** If the area of a triangle whose base measures 6cm is  $18\text{cm}^2$ , then its height is:

- Ans**
- 1. 6 cm
  - 2. 3.1 cm
  - 3. 2.2 cm
  - 4. 9 cm

**Q.6** There are 160 multiple choice questions in a test. 4 marks are allotted for a correct answer and 1 mark is deducted for a wrong answer or un-attempted question from the total score of correct answers. If a candidate scored 400 marks in the test, how many questions did he answer correctly?

- Ans**
- 1. 110
  - 2. 115
  - 3. 112
  - 4. 120

Q.7 In an election between two candidates, one got 60% of the total valid votes and 15% of the votes were invalid. If the total number of votes were 8400, the number of valid votes that the other candidate got were:

- Ans
- ✓ 1. 2856
  - ✗ 2. 2998
  - ✗ 3. 3117
  - ✗ 4. 3213

Q.8 When  $x$  is added to each of the numbers 7, 11, 18 and 23, then the number so obtained are in proportion. What is the mean proportional between the  $(x - 1)$  and  $(2x - 10)$ ?

- Ans
- ✗ 1. 68
  - ✗ 2. 78
  - ✗ 3. 98
  - ✓ 4. 48

Q.9 Read the given information and answer the question that follows.

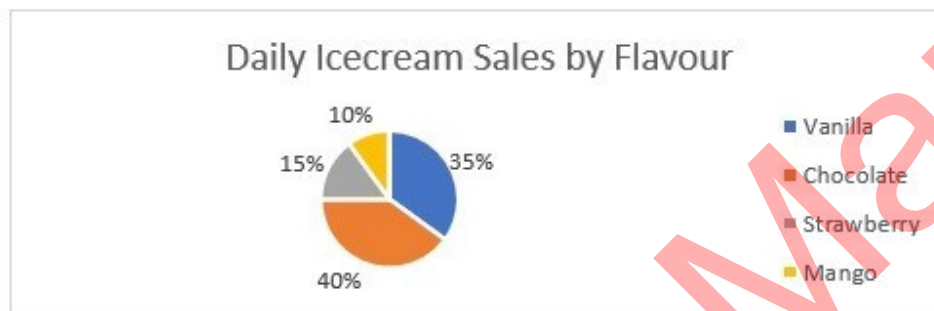

If 400 chocolate ice creams are sold in a day, how many vanilla ice creams are sold?

- Ans
- ✗ 1. 100
  - ✓ 2. 350
  - ✗ 3. 300
  - ✗ 4. 400

Q.10 The distribution of total 1500 students in a school for different games is shown in the following figure. Study the given figure carefully and answer the question that follows.

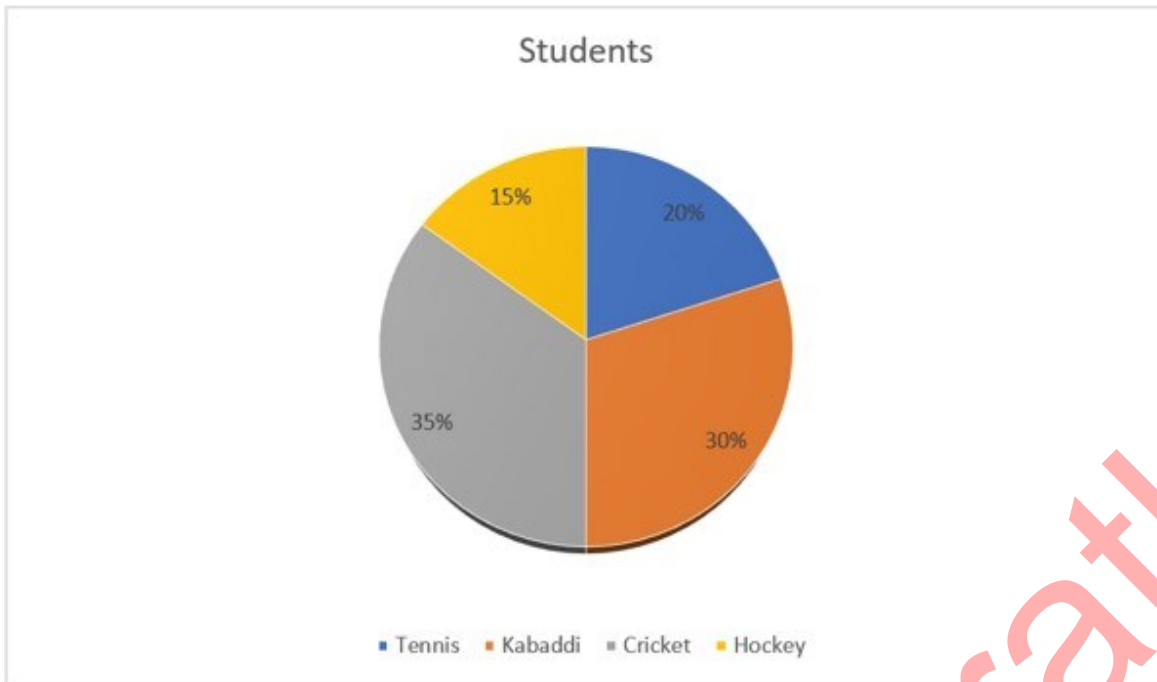

Find the total number of students selected for cricket and tennis.

- Ans
- 1. 825
  - 2. 525
  - 3. 415
  - 4. 625

Q.11 Simplify the following expression.

$$2\frac{1}{4} \times 3\frac{1}{5} + 5\frac{1}{6} \text{ of } 2\frac{4}{31} \div 3\frac{2}{3} + 4\frac{1}{7} \text{ of } 1\frac{6}{29}$$

- Ans
- 1.  $13\frac{1}{5}$
  - 2.  $16\frac{1}{5}$
  - 3.  $14\frac{1}{5}$
  - 4.  $15\frac{1}{5}$

Q.12  $\triangle ABC \sim \triangle EDF$  and  $\text{area}(\triangle ABC) : \text{area}(\triangle EDF) = 9 : 4$ . If  $AB = 5$  cm,  $BC = 8$  cm and  $CA = 10$  cm, then  $DF$  is equal to:

- Ans
- 1.  $3\frac{2}{3}$  cm
  - 2.  $3\frac{1}{4}$  cm
  - 3.  $5\frac{1}{3}$  cm
  - 4.  $4\frac{2}{3}$  cm

Q.13 If  $\alpha + \beta = 45^\circ$  and  $(\tan \alpha + 1)(\tan \beta + 1) = 2x$ , then  $x$  is:

- Ans
- 1. 2
  - 2. -1
  - 3. 0
  - 4. 1

Q.14 Study the given bar-graph and answer the question that follows.

The bar-graph shows the production (in lakh) of kitchen appliances manufactured by three companies A, B, and C over a period of six years from 2012 to 2017.

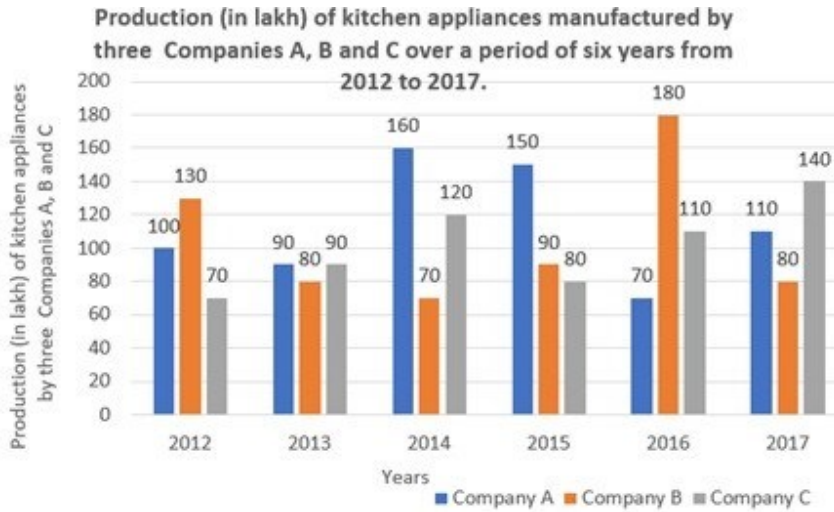

In which year was the percentage of rise / fall in production from the previous year the maximum for company C?

Ans

- 1. 2013
- 2. 2017
- 3. 2016
- 4. 2015

Q.15 A seller decreased the selling price of each item from ₹5,000 to ₹4,680, by which his loss percentage increased by 4%. If he has to get 4% profit, then the selling price of the item should be:

Ans

- 1. ₹7,280
- 2. ₹8,320
- 3. ₹8,840
- 4. ₹7,800

Q.16 What is the discount that Rohan should offer on the remaining ₹8,000 of a laptop priced at ₹48,000, given that, he has already given a 12% discount on the first ₹28,000 and 8% discount on the next ₹12,000 to match the discount amount of 9.5% given on the total price?

Ans

- 1. ₹402
- 2. ₹420
- 3. ₹240
- 4. ₹204

Q.17 A class of 25 students took an English test. 15 students had an average score of 80. The other students had an average score of 60. What is the average score of the whole class?

Ans

- 1. 80
- 2. 76
- 3. 74
- 4. 72

Q.18 Study the given graph and answer the question that follows.

The graph shows the exports from three companies (A, B and C) over the years (in ₹ crore).

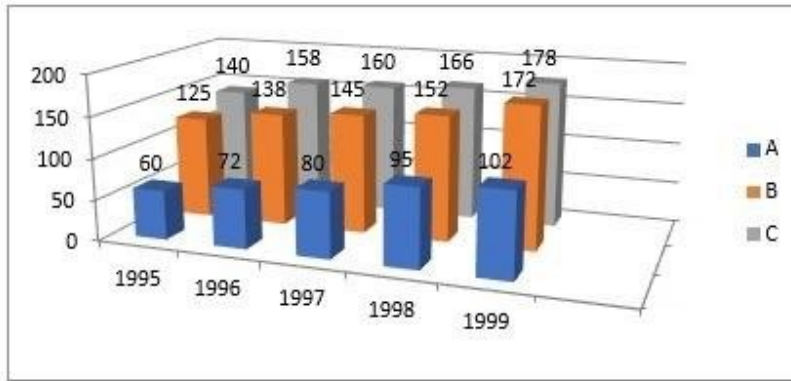

In which year was the difference between the exports from companies A and B the minimum?

- Ans
- 1. 1997
  - 2. 1998
  - 3. 1995
  - 4. 1994

Q.19 The simple interest on a sum for 8 years is  $\frac{4}{5}$  of the sum. The rate of interest per annum is:

- Ans
- 1. 5%
  - 2. 15%
  - 3. 10%
  - 4. 20%

Q.20 Two circles with centre O and A touch each other externally. The radius of the first circle with centre O is 6 cm. The radius of the second circle with centre A is 3 cm. Find the length of their common tangent CB (in centimetres).

- Ans
- 1.  $3\sqrt{2}$
  - 2.  $4\sqrt{3}$
  - 3.  $4\sqrt{2}$
  - 4.  $6\sqrt{2}$

Q.21 Two parallel chords of length 8 units each are 6 units away from each other in a circle. What is the radius of the circle in units?

- Ans
- 1. 3
  - 2. 6
  - 3. 5
  - 4. 4

Q.22 When the integer  $n$  is divided by 18, the quotient is  $x$  and the remainder is 6, When the integer  $n$  is divided by 25, the quotient is  $y$  and the remainder is 15. Which of the following is true?

- Ans
- 1.  $25y + 18x = 9$
  - 2.  $25y - 18x = 9$
  - 3.  $18x + 25y = 9$
  - 4.  $18x - 25y = 9$

Q.23 Rakesh is the owner of a rectangular field. Because of the construction of an expressway near his field, the length and breadth of his field are reduced by 30% and 10%, respectively. What is the percentage decrease in the area of his field?

- Ans
- 1. 40%
  - 2. 35%
  - 3. 37%
  - 4. 33%

Q.24 Ram and Shyam start walking from the same place in the opposite direction. If Shyam walks at a speed of  $5\frac{1}{4}$  km/hr and Ram at a speed of 3 km/hr, then after how much time will they be 44 km apart?

- Ans
- 1. 3 hours 20 minutes
  - 2. 5 hours 20 minutes
  - 3. 6 hours 20 minutes
  - 4. 4 hours 20 minutes

Q.25 A cylindrical rod of iron whose height is twelve times its radius, is melted and cast into spherical balls, each of one-third the radius of the cylinder. Find the number of spherical balls.

- Ans
- 1. 224
  - 2. 212
  - 3. 243
  - 4. 198

Section : General Awareness

Q.1 What is the name of the festival that ends the Holy Ramzan month?

- Ans
- 1. Eid- Ul- Fitr
  - 2. Muharram
  - 3. Eid- Ul- Zuha
  - 4. Bakrid

2. The Palas were:

- Ans
- 1. a dynasty that appeared in Puri
  - 2. a dynasty that first appeared in Cambodia
  - 3. a dynasty that united eastern India and Burma
  - 4. a dynasty that appeared in eastern India

3. The largest inland salt lake 'Sambhar' is located in the \_\_\_\_\_ of India.

- Ans
- 1. north-east
  - 2. south-east
  - 3. south-west
  - 4. north-west

Q.4 In India, the musical instrument "Flute" is also known as \_\_\_\_\_.

- Ans
- 1. Tabla
  - 2. Manjira
  - 3. Bansuri
  - 4. Veena



Q.5 According to Global Multidimensional poverty index (2022), On the basis of four indicators- nutrition, cooking fuel, sanitation and housing, how much poor people live in India?

- Ans
- 1. 24.4 million
  - 2. 54.4 million
  - 3. 44.4 million
  - 4. 34.4 million

Q.6 In Microsoft Excel, which chart type is best suited for comparing proportions or percentages of a whole?

- Ans
- 1. Pie Chart
  - 2. Bar Chart
  - 3. Scatter Chart
  - 4. Line Chart

Q.7 Who wrote the book 'Gulamgiri'?

- Ans
- 1. Jyotiba Phule
  - 2. Dwarkanath Tagore
  - 3. Swami Shradhanand
  - 4. BR Ambedkar

Q.8 In cost theory, the usual shape of the \_\_\_\_\_ curve is a rectangular hyperbola.

- Ans
- 1. total cost
  - 2. fixed cost
  - 3. average fixed cost
  - 4. variable cost

Q.9 Which of the following sequences is correct, according to taxonomy?

- Ans
- 1. Class-Phylum-Family-Order Genus-Species
  - 2. Family-Phylum-Class-Order-Genus-Species
  - 3. Phylum-Class-Order-Family-Genus-Species
  - 4. Class-Phylum-Order-Family-Genus-Species

Q.10 Which of the following teams won the IPL 2023 championship?

- Ans
- 1. Gujarat Titans
  - 2. Mumbai Indians
  - 3. Lucknow SuperGiants
  - 4. Chennai Super Kings

Q.11 Norman Ernest Borlaug was awarded the \_\_\_\_\_ in 1970 for his contributions to the green revolution.

- Ans
- 1. Nobel Peace Prize
  - 2. Nobel Prize in Physiology
  - 3. Nobel Prize in Chemistry
  - 4. Nobel Prize in Physics

Q.12 Who among the following discovered that a wire carrying electric current can attract or repel another wire next to it that's also carrying electric current?

- Ans
- 1. Michael Faraday
  - 2. Andre-Marie Ampere
  - 3. Guglielmo Marconi
  - 4. James Maxwell

Q.13 Which Articles of the Constitution deal with citizenship?

- Ans
- 1. Articles 5 to 11
  - 2. Articles 5 to 10
  - 3. Articles 5 to 8
  - 4. Articles 5 to 9

Q.14 The establishment of Union Public Service Commission, State Public Service Commissions and Joint Public Service Commission falls under which of the following features of the Constitution of India?

- Ans
- 1. Federalism
  - 2. Parliamentary Government
  - 3. Directive Principles of State Policy
  - 4. Fundamental Rights

Q.15 Chhannulal Mishra is related to which Musical Lineage?

- Ans
- 1. Agara Musical Family
  - 2. Delhi Musical Family
  - 3. Kirana Musical Family
  - 4. Jaipur Musical Family

Q.16 According to the Census of India 2011, which of the following states is the most urbanised?

- Ans
- 1. Goa
  - 2. Kerala
  - 3. Himachal Pradesh
  - 4. Punjab

Q.17 On 7 November 2022, the Supreme Court of India upheld the reservations for the weaker sections (EWS). Which of the following amendments brought this reservation in the first place?

- Ans
- 1. 103<sup>rd</sup> Amendment of the Constitution
  - 2. 102<sup>nd</sup> Amendment of the Constitution
  - 3. 104<sup>th</sup> Amendment of the Constitution
  - 4. 101<sup>st</sup> Amendment of the Constitution

Q.18 The moderate margin of a page in MS Word can be applied to the page from which of the following?

- Ans
- 1. Page Layout Tab
  - 2. Design Tab
  - 3. Review tab
  - 4. View Tab

Q.19 Who was the first Indian woman wrestler to win a medal at the Olympics?

- Ans
- 1. Alka Tomar
  - 2. Babita Phogat
  - 3. Geeta Phogat
  - 4. Sakshi Malik

Q.20 'Chang dance' is popular in the state of:

- Ans
- 1. Goa
  - 2. Tripura
  - 3. Rajasthan
  - 4. Bihar

Q.21 Who among the following cabinet ministers was appointed as the Governor of Karnataka in July 2021?

- Ans
- 1. Arjun Munda
  - 2. Rajendra Vishwanath
  - 3. Thawarchand Gehlot
  - 4. Hari Babu Kambhampati

Q.22 Which dwarf planet orbits the sun in 310 years at a distance between 38.5 to 53 AU?

- Ans
- 1. Ceres
  - 2. Eris
  - 3. Makemake
  - 4. Pluto

Q.23 Which country hosted the first FIFA World Cup?

- Ans
- 1. Brazil
  - 2. Italy
  - 3. Uruguay
  - 4. France

Q.24 Dinesh K Tripathi was appointed as \_\_\_\_\_ in January, 2024

- Ans
- 1. Vice Chief of Naval Staff
  - 2. Chief of Naval Staff
  - 3. Rear Admiral
  - 4. Chief of Personnel

Q.25 According to Ministry of Agriculture and Farmers Welfare, what was the total food grain production of India in the year 2022-23?

- Ans
- 1. 2266.23 lakh tonnes
  - 2. 2876.17 lakh tonnes
  - 3. 2491.58 lakh tonnes
  - 4. 3296.87 lakh tonnes

## Combined Higher Secondary Level Examination 2024 Tier I

Exam Date	04/07/2024
Exam Time	9:00 AM - 10:00 AM
Subject	CHSL Exam 2024 Tier I

### Section : English Language

1. The given sentence is divided into four segments. Select the option that has the segment with a grammatical error. I am sure / that he will praying / for a good crop / this year.

Ans  1. that he will praying  
 2. I am sure  
 3. this year.  
 4. for a good crop

2. The following sentence has been divided into four segments. Identify the segment that contains a grammatical error.

My students are / waiting for / their flights / at the gate no. 6.

Ans  1. at the gate no. 6.  
 2. waiting for  
 3. their flights  
 4. My students are

3. The following sentence has been split into four segments. Identify the segment that contains a grammatical error. I am very much / obliged of my friend / for the help / he rendered to me.

Ans  1. I am very much  
 2. he rendered to me  
 3. for the help  
 4. obliged of my friend

- Q.4 Parts of the following sentence have been underlined and given as options. Select the option that contains an error. She will being studying for her exams tomorrow.

Ans  1. studying  
 2. tomorrow  
 3. will being  
 4. exams

**Comprehension:**

In the following passage, some words have been deleted. Read the passage carefully and select the most appropriate option to fill in each blank.

Oil is almost certainly one of the ocean's greatest resources. 33% of the world's oil comes from seaward fields in seas. Oils are liquids that easily burn and do not (1)\_\_\_\_\_in water. Most of the time, they are made of chains of carbon and hydrogen atoms. There are three (2)\_\_\_\_\_types of oils: mineral, essential and fixed oils. From plants, essential oils are thin, scented oils. Because they frequently have an odour, essential oils are (3)\_\_\_\_\_in perfumery and food flavouring. Aromatic extraction processes like cold pressing, distillation and extraction are typically used to prepare essential oils. Fatty acids are used by animals and plants to make fixed oils. They are especially non-volatile oils that are found in the seeds of cotton, corn, flax, sunflowers, peanuts, coconuts and olives, as well as in fatty animal tissues. Mineral oils are (4)\_\_\_\_\_from petroleum which has been underground for millions of years from sea organism skeletons. Mineral oils are one of the petroleum by-products with the lowest prices. Mineral oils are colourless and transparent. They are made up of a (5)\_\_\_\_\_of hydrocarbons.

**SubQuestion No : 5**

**Q.5** Select the most appropriate option to fill in blank number 1.

- Ans**
- 1. dissolve
  - 2. diffuse
  - 3. melt
  - 4. evaporate

**Comprehension:**

In the following passage, some words have been deleted. Read the passage carefully and select the most appropriate option to fill in each blank.

Oil is almost certainly one of the ocean's greatest resources. 33% of the world's oil comes from seaward fields in seas. Oils are liquids that easily burn and do not (1)\_\_\_\_\_in water. Most of the time, they are made of chains of carbon and hydrogen atoms. There are three (2)\_\_\_\_\_types of oils: mineral, essential and fixed oils. From plants, essential oils are thin, scented oils. Because they frequently have an odour, essential oils are (3)\_\_\_\_\_in perfumery and food flavouring. Aromatic extraction processes like cold pressing, distillation and extraction are typically used to prepare essential oils. Fatty acids are used by animals and plants to make fixed oils. They are especially non-volatile oils that are found in the seeds of cotton, corn, flax, sunflowers, peanuts, coconuts and olives, as well as in fatty animal tissues. Mineral oils are (4)\_\_\_\_\_from petroleum which has been underground for millions of years from sea organism skeletons. Mineral oils are one of the petroleum by-products with the lowest prices. Mineral oils are colourless and transparent. They are made up of a (5)\_\_\_\_\_of hydrocarbons.

**SubQuestion No : 6**

**Q.6** Select the most appropriate option to fill in blank number 2.

- Ans**
- 1. initial
  - 2. original
  - 3. early
  - 4. primary

**Comprehension:**

In the following passage, some words have been deleted. Read the passage carefully and select the most appropriate option to fill in each blank.

Oil is almost certainly one of the ocean's greatest resources. 33% of the world's oil comes from seaward fields in seas. Oils are liquids that easily burn and do not (1)\_\_\_\_\_in water. Most of the time, they are made of chains of carbon and hydrogen atoms. There are three (2)\_\_\_\_\_types of oils: mineral, essential and fixed oils. From plants, essential oils are thin, scented oils. Because they frequently have an odour, essential oils are (3)\_\_\_\_\_in perfumery and food flavouring. Aromatic extraction processes like cold pressing, distillation and extraction are typically used to prepare essential oils. Fatty acids are used by animals and plants to make fixed oils. They are especially non-volatile oils that are found in the seeds of cotton, corn, flax, sunflowers, peanuts, coconuts and olives, as well as in fatty animal tissues. Mineral oils are (4)\_\_\_\_\_from petroleum which has been underground for millions of years from sea organism skeletons. Mineral oils are one of the petroleum by-products with the lowest prices. Mineral oils are colourless and transparent. They are made up of a (5)\_\_\_\_\_of hydrocarbons.

**SubQuestion No : 7**

**Q.7** Select the most appropriate option to fill in blank number 3.

- Ans**
- 1. applied
  - 2. utilised
  - 3. operated
  - 4. employed

**Comprehension:**

In the following passage, some words have been deleted. Read the passage carefully and select the most appropriate option to fill in each blank.

Oil is almost certainly one of the ocean's greatest resources. 33% of the world's oil comes from seaward fields in seas. Oils are liquids that easily burn and do not (1)\_\_\_\_\_in water. Most of the time, they are made of chains of carbon and hydrogen atoms. There are three (2)\_\_\_\_\_types of oils: mineral, essential and fixed oils. From plants, essential oils are thin, scented oils. Because they frequently have an odour, essential oils are (3)\_\_\_\_\_in perfumery and food flavouring. Aromatic extraction processes like cold pressing, distillation and extraction are typically used to prepare essential oils. Fatty acids are used by animals and plants to make fixed oils. They are especially non-volatile oils that are found in the seeds of cotton, corn, flax, sunflowers, peanuts, coconuts and olives, as well as in fatty animal tissues. Mineral oils are (4)\_\_\_\_\_from petroleum which has been underground for millions of years from sea organism skeletons. Mineral oils are one of the petroleum by-products with the lowest prices. Mineral oils are colourless and transparent. They are made up of a (5)\_\_\_\_\_of hydrocarbons.

**SubQuestion No : 8**

**Q.8** Select the most appropriate option to fill in blank number 4.

- Ans**
- 1. produced
  - 2. invented
  - 3. renewed
  - 4. fabricated

**Comprehension:**

In the following passage, some words have been deleted. Read the passage carefully and select the most appropriate option to fill in each blank.

Oil is almost certainly one of the ocean's greatest resources. 33% of the world's oil comes from seaward fields in seas. Oils are liquids that easily burn and do not (1)\_\_\_\_\_in water. Most of the time, they are made of chains of carbon and hydrogen atoms. There are three (2)\_\_\_\_\_types of oils: mineral, essential and fixed oils. From plants, essential oils are thin, scented oils. Because they frequently have an odour, essential oils are (3)\_\_\_\_\_in perfumery and food flavouring. Aromatic extraction processes like cold pressing, distillation and extraction are typically used to prepare essential oils. Fatty acids are used by animals and plants to make fixed oils. They are especially non-volatile oils that are found in the seeds of cotton, corn, flax, sunflowers, peanuts, coconuts and olives, as well as in fatty animal tissues. Mineral oils are (4)\_\_\_\_\_from petroleum which has been underground for millions of years from sea organism skeletons. Mineral oils are one of the petroleum by-products with the lowest prices. Mineral oils are colourless and transparent. They are made up of a (5)\_\_\_\_\_of hydrocarbons.

**SubQuestion No : 9**

**Q.9** Select the most appropriate option to fill in blank number 5.

- Ans**
- 1. collaboration
  - 2. cooperation
  - 3. combination
  - 4. association

**Q.10** Select the most appropriate ANTONYM of the given word.  
Merit

- Ans**
- 1. Result
  - 2. Tumult
  - 3. Fault
  - 4. Occult

**Q.11** Select the correct spelling of the underlined word in the following sentence.  
I am contant with my day's work.

- Ans**
- 1. contint
  - 2. contante
  - 3. content
  - 4. cuntent

**Q.12** Select the most appropriate option to fill in the blank.

The \_\_\_\_\_ in my shoelace created a lot of trouble.

- Ans**
- 1. not
  - 2. naught
  - 3. nought
  - 4. knot

Q.13 Select the most appropriate option that can substitute the underlined segment in the given sentence.  
If you are thinking about investing in share markets, isn't it make sense to find an expert?

- Ans
- 1. did it
  - 2. is it
  - 3. doesn't it
  - 4. do it

Q.14 Select the most appropriate ANTONYM of the given word.  
Important

- Ans
- 1. Recurring
  - 2. Productive
  - 3. Trivial
  - 4. Significant

Q.15 Select the most appropriate meaning of the underlined idiom in the following sentence.  
Independence Day is considered as a red-letter day in the history of India.

- Ans
- 1. Regular day
  - 2. Uneventful day
  - 3. Memorable day
  - 4. Unimportant day

Q.16 Select the most appropriate option that can substitute the underlined segment in the given sentence.  
He lived on the bank of a mighty river, broad and deep, that have always silently rolling on to a vast undiscovered ocean.

- Ans
- 1. which were always silently rolling
  - 2. which was always silently rolling
  - 3. that were always silently rolling
  - 4. what has always silently rolling

Q.17 Select the most appropriate homophone to fill in the blank.  
Namita still cannot \_\_\_\_\_ the pain of her cat's untimely demise.

- Ans
- 1. bier
  - 2. bear
  - 3. beer
  - 4. bare

Q.18 Select the most appropriate option to fill in the blank.

A sailor was \_\_\_\_\_ through the high tides.

- Ans
- 1. ceiling
  - 2. sailing
  - 3. swelling
  - 4. selling

Q.19 Select the most appropriate meaning of the underlined idiom.  
Vishnu and Vignesh are always like two peas in a pod.

- Ans
- 1. Very similar to each other
  - 2. Smart and intelligent
  - 3. Happy and compassionate
  - 4. Good in every way

Q.20 Select the most appropriate option to fill in the blank.

The crowd gave them a \_\_\_\_\_ of applause.

- Ans
- 1. yell
  - 2. load
  - 3. laugh
  - 4. round

Q.21 Select the most appropriate option that can substitute the underlined segment in the given sentence. If there is no need to substitute it, select 'No substitution required'.

Applications are to be sent to the school's e-mail ID before 30<sup>th</sup> June.

- Ans
- 1. will be send to
  - 2. is sending
  - 3. No substitution required
  - 4. would be send to

Q.22 Select the INCORRECTLY spelt word.

- Ans
- 1. Adulterous
  - 2. Amendment
  - 3. Advertisement
  - 4. Astounding

Q.23 Select the most appropriate option that can substitute the underlined segment in the given sentence. The painting look good in this room.

- Ans
- 1. have looking
  - 2. looking
  - 3. had look
  - 4. looks

Q.24 Replace the underlined word in the given sentence with an appropriate synonym from the options listed below. They gave us the impression that Clara was a cold and calculating woman, who was only after power.

- Ans
- 1. callous
  - 2. unscrupulous
  - 3. unsympathetic
  - 4. manipulative

Q.25 Fill in the blank with the most appropriate ANTONYM of the underlined word.

Gentlemen always go for a lawful approach, but rouses choose \_\_\_\_\_ ways to solve problems.

- Ans
- 1. legal
  - 2. legitimate
  - 3. sophisticated
  - 4. illicit

Section : General Intelligence

1. In a certain code language,  
'M & N' means 'M is the wife of N',  
'M @ N' means 'M is the brother of N',  
'M \$ N' means 'M is the father of N',  
'M # N' means 'M is the son of N'.  
Based on the above, how is T related to G if 'T @ S # M & N \$ G'?

- Ans
- 1. Brother
  - 2. Father
  - 3. Son
  - 4. Father's brother



2. Select the combination of letters that when sequentially placed in the blanks of the given series will logically complete the series.

\_ F \_ G E E \_ E \_ E E F \_ G E E \_ E G \_

- Ans
- 1. EEFGEFE
  - 2. EFGFEFF
  - 3. EFFGFEE
  - 4. FEFGFFE

Q.3 What should come in place of the question mark (?) in the given series?

22, 24, 28, 30, 34, ?

- Ans
- 1. 36
  - 2. 35
  - 3. 37
  - 4. 38

Q.4 Based on the alphabetical order, three of the following four letter-clusters are alike in a certain way and thus form a group. Which letter-cluster does not belong to that group?  
(Note: The odd one out is not based on the number of consonants/vowels or their position in the letter cluster.)

- Ans
- 1. PRV
  - 2. HJN
  - 3. GIM
  - 4. EGJ

Q.5 The position of how many letters will remain unchanged if each of the letters in the word SOUNDBAR is arranged in alphabetical order?

- Ans
- 1. Three
  - 2. Four
  - 3. One
  - 4. Two

Q.6 How many rectangles are there in the given figure?

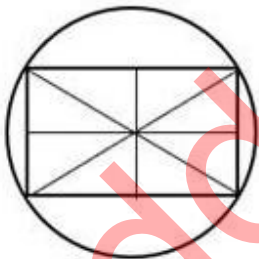

- Ans
- 1. 9
  - 2. 7
  - 3. 8
  - 4. 6

Q.7 What should come in place of ? in the given series based on the English alphabetical order?

RST VZW ZGZ DNC ?

- Ans
- 1. ALF
  - 2. HUF
  - 3. COD
  - 4. MOC

Q.8 Select the word-pair that best represents a similar relationship to the one expressed in the pair of words given below. (The words must be considered as meaningful English words and must not be related to each other based on the number of letters/number of consonants/vowels in the word.)

Palate : Mouth

- Ans
- 1. Hill : Range
  - 2. Rivulet : Dam
  - 3. Ceiling : Room
  - 4. Rainbow : Sky

Q.9 What would be the symbol on the opposite side of '\*' if the given sheet is folded to form a cube?

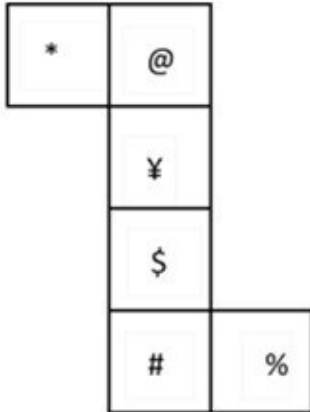

- Ans
- 1. ¥
  - 2. #
  - 3. \$
  - 4. %

Q.10 If 16 July 2001 is Monday, then what will be the day of the week on 23 December 2006?

- Ans
- 1. Wednesday
  - 2. Monday
  - 3. Thursday
  - 4. Saturday

Q.11 What should come in place of the question mark (?) in the given series?

13, 22, 33, 46, ?, 78, 97

- Ans
- 1. 60
  - 2. 65
  - 3. 61
  - 4. 56

Q.12 Identify the figure in the options that when put in place of the question mark (?) will logically complete the series?

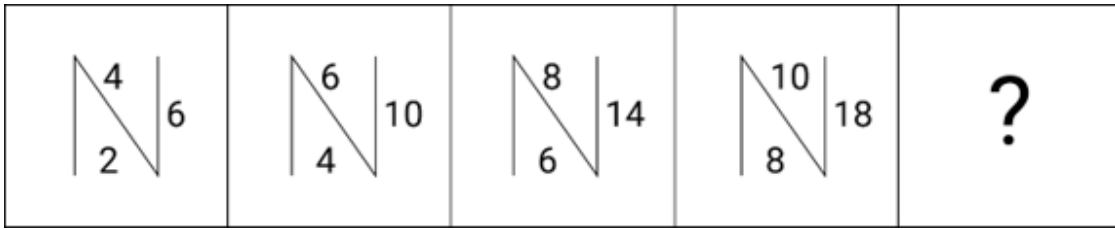

Ans

✗ 1.

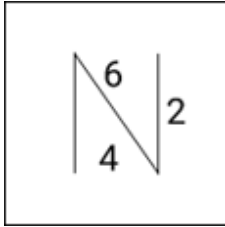

✗ 2.

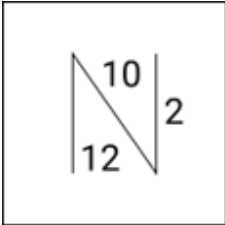

✗ 3.

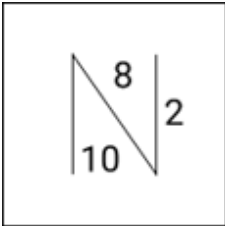

✓ 4.

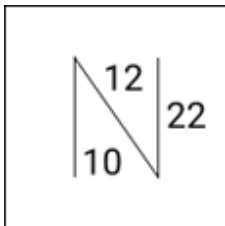

Q.13 What will come in the place of the question mark (?) in the following equation, if '+' and '×' are interchanged and '-' and '÷' are interchanged?

$$35 \times 96 - 8 + 3 \div 11 = ?$$

Ans

✗ 1. 55

✓ 2. 60

✗ 3. 40

✗ 4. 42

Q.14 Select the correct mirror image of the given combination when the mirror is placed at 'MN' as shown below.



- Ans
- 1. nAɔE1ɔθ
  - 2. nAɔE1Gθ
  - 3. AnɔE1ɔθ
  - 4. nAnɔE1ɔθ

Q.15 What would be the word on the opposite side of 'Eat' if the given sheet is folded to form a cube?



- Ans
- 1. Cry
  - 2. Play
  - 3. Fly
  - 4. Pray

Q.16 In a certain code language, 'I missed breakfast' is written as 'nl zn kq' and 'train is missed' is written as 'zm kg nl'. How is 'missed' written in the given language?

- Ans
- 1. zn
  - 2. kq
  - 3. nl
  - 4. zm

Q.17 Select the option figure in which the given figure (X) is embedded as its part (rotation is NOT allowed).



(X)

Ans

✗ 1.



✗ 2.



✗ 3.



✓ 4.



Q.18 If 'A' stands for '+', 'B' stands for '×', 'C' stands for '÷' and 'D' stands for '−', what will come in place of the question mark (?) in the following equation?

$$32 \text{ B } 4 \text{ D } 116 \text{ A } 2 \text{ C } 13 = ?$$

Ans

✓ 1. 83

✗ 2. 84

✗ 3. 81

✗ 4. 82

Q.19 In a certain code language, MOAT' is coded as '8652' and 'TRAM' is coded as '4256'. What is the code for 'R' in the given code language?

Ans

✗ 1. 8

✗ 2. 6

✓ 3. 4

✗ 4. 2

Q.20 529 is related to 23 following a certain logic. Following the same logic, 324 is related to 18. To which of the following is related 625 following the same logic?  
(NOTE : Operations should be performed on the whole numbers, without breaking down the numbers into its constituent digits. E.g. 13 – Operations on 13 such as adding /deleting /multiplying etc., to 13 can be performed. Breaking down 13 into 1 and 3 and then performing mathematical operations on 1 and 3 is not allowed.)

- Ans
- 1. 23
  - 2. 35
  - 3. 27
  - 4. 25

Q.21 Select the correct mirror image of the given figure when the mirror is placed at MN as shown below.



- Ans
- 1.
  - 2.
  - 3.
  - 4.

Q.22 Read the given statements and conclusions carefully. Assuming that the information given in the statements is true, even if it appears to be at variance with commonly known facts, decide which of the given conclusions logically follow(s) from the statements.

Statements:

All rings are bangles.

Some bangles are anklets.

No anklet is a pendant.

Conclusions:

(I) All rings being anklets is a possibility.

(II) All bangles can never be pendants.

- Ans
- 1. Only conclusion II follows
  - 2. Both conclusions I and II follow
  - 3. Only conclusion I follows
  - 4. None of the conclusions follow

Q.23 Select the word-pair that best represents a similar relationship to the one expressed in the pair of words given below.

(The words must be considered as meaningful English words and must not be related to each other based on the number of letters/number of consonants/vowels in the word)

India : Mango

- Ans
- 1. Greece : Banana
  - 2. New Zealand : Kiwi
  - 3. Australia : Grapes
  - 4. France : Apple

24. If 'J' stands for '+', 'V' stands for '×', 'K' stands for '+' and 'A' stands for '-', what will come in place of the question mark (?) in the following equation?  
12 J 2 K 17 A 15 V 19 = ?

- Ans
- 1. -262
  - 2. -75
  - 3. -76
  - 4. -776

25. Select the set in which the numbers are related in the same way as are the numbers of the following sets.  
(NOTE: Operations should be performed on the whole numbers, without breaking down the numbers into its constituent digits. E.g. 13 – Operations on 13 such as adding/deleting/multiplying etc. to 13 can be performed. Breaking down 13 into 1 and 3 and then performing mathematical operations on 1 and 3 is not allowed.)  
(5, 25, 50)  
(8, 64, 128)

- Ans
- 1. (12, 144, 278)
  - 2. (12, 144, 288)
  - 3. (12, 134, 288)
  - 4. (12, 144, 298)

Section : Quantitative Aptitude

Q.1 What is the value of  $\tan 570^\circ$ ?

- Ans
- 1.  $-\frac{1}{\sqrt{3}}$
  - 2.  $-\sqrt{3}$
  - 3.  $\frac{1}{\sqrt{3}}$
  - 4.  $\sqrt{3}$

Q.2 A clock is sold for ₹550 cash or in the instalment scheme, for ₹250 cash down payment and ₹310 after one month. Find the rate of interest charged in the instalment scheme.

- Ans
- 1. 40%
  - 2. 20%
  - 3. 35%
  - 4. 45%

3. A person spends 10% of his income on groceries, 10% on medicines, 20% on children's education, 15% on house rent, and he saves the remaining amount. If his monthly income is ₹30,000, find his savings.

- Ans
- 1. ₹15,500
  - 2. ₹16,500
  - 3. ₹13,500
  - 4. ₹12,500

Q.4 In a state election between two parties, 83% of the voters cast their votes, out of which 4% of the votes were declared invalid. Party A got 156611 votes which were 83% of the total valid votes. Find the total number of votes enrolled in that election. (Consider integer part only)

- Ans
- 1. 2,58,233
  - 2. 2,34,888
  - 3. 2,36,807
  - 4. 23,46,807

Q.5 A man looks at the reflection of the top of the lamp-post on the mirror that is 6.6 m away from the foot of the lamppost. The man's height is 1.25 m and he is standing 2 m away from the mirror. Assuming that the mirror is placed on the ground, facing the sky and the man, and that the mirror and the lamp-post are in a same line, find the height of the lamp-post (in metres).

- Ans
- 1. 4.28
  - 2. 4.45
  - 3. 3.97
  - 4. 4.13

Q.6 Given below is the observed data of the ages of various children.

Age in years	Number of children
6	8
7	3
8	7
9	2
10	20

What is the mean of the ages of the children?

- Ans
- 1. 6.575 years
  - 2. 8.575 years
  - 3. 7.575 years
  - 4. 5.575 years

Q.7 The number nearest to 7658 and exactly divisible by 45 is:

- Ans
- 1. 7645
  - 2. 7660
  - 3. 7650
  - 4. 7640

Q.8 There is a circle with a centre T and a radius of 8 cm. Two tangents KE and KI are drawn from point K, which is 17 cm from the centre. The area of the quadrilateral TEKI is:

- Ans
- 1. 130 sq.cm
  - 2. 136 sq.cm
  - 3. 120 sq.cm
  - 4. 127.5 sq.cm

Q.9  $\triangle ABC$  is a right-angled triangle where  $m\angle ABC = 90^\circ$ . If  $m(\overline{AB}) = 15$  cm,  $m(\overline{BC}) = 20$  cm, and  $\overline{BD} \perp \overline{AC}$ , intersecting  $\overline{AC}$  at the point D, find  $m(\overline{BD})$  (in cm).

- Ans
- 1. 12.5
  - 2. 12
  - 3. 10
  - 4. 9



Q.10 In the year 2000, Monu was 3 times his sister's age. In 2010, he was 24 years older than her. Find Monu's age in 2010.

Ans  1. 46 years

2. 52 years

3. 38 years

4. 62 years

Q.11 The given bar graph shows the number of accidents in a city during the first 6 months of a year. Examine the bar graph and answer the question.

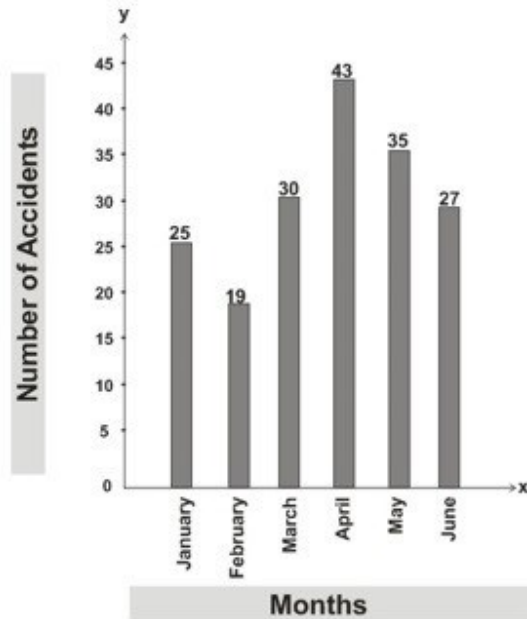

What is the percentage of accidents in the month of April with respect to the total accidents in the city during six months? (Correct to nearest integer)

Ans  1. 15%

2. 24%

3. 20%

4. 22%

Q.12 The following bar graph represents the population of a city (in lakhs) as per the census across different years.

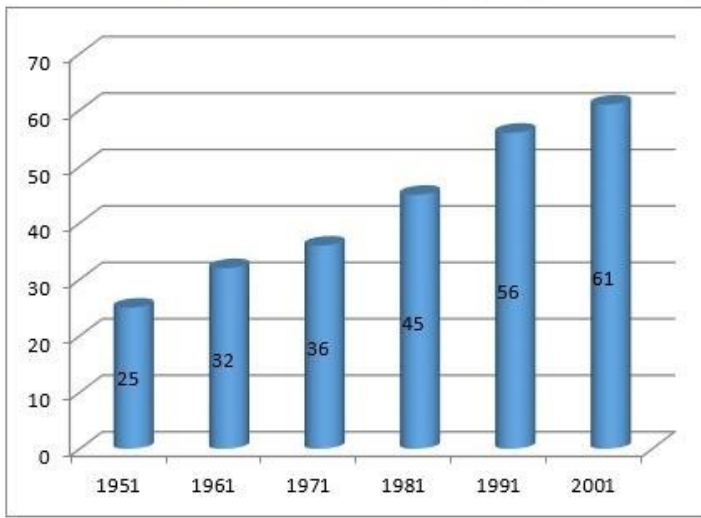

What is the per cent increase in population from 1951 to 2001?

- Ans
- 1. 144%
  - 2. 22%
  - 3. 35%
  - 4. 120%

Q.13 Which of the following numbers is divisible by 22?

- Ans
- 1. 893002
  - 2. 645372
  - 3. 602351
  - 4. 654320

Q.14 Shankar covers a certain distance by a car driving at 40 km/h and he returns to the starting point riding on a scooter with a speed of 20 km/h. Find the average speed of the whole journey.

- Ans
- 1.  $22\frac{2}{3}$  km/h
  - 2.  $29\frac{2}{3}$  km/h
  - 3.  $24\frac{2}{3}$  km/h
  - 4.  $26\frac{2}{3}$  km/h

Q.15 The pie chart, given here, shows the various expenses of a publisher in the production of a magazine.

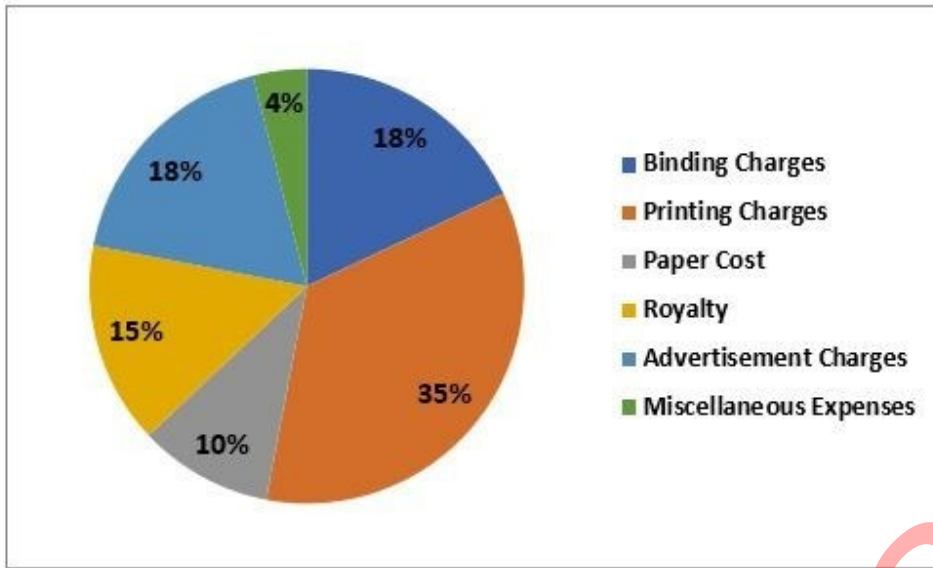

What is the difference between the measures of the central angles of sectors for binding charges and paper cost?

- Ans
- 1.  $28.8^\circ$
  - 2.  $27.2^\circ$
  - 3.  $28.6^\circ$
  - 4.  $27.6^\circ$

Q.16 Three solid cubes of metal have sides 6 cm, 8 cm and 10 cm, respectively. They are melted to form a new cube. What is the surface area of this new cube?

- Ans
- 1.  $915 \text{ cm}^2$
  - 2.  $864 \text{ cm}^2$
  - 3.  $950 \text{ cm}^2$
  - 4.  $812 \text{ cm}^2$

Q.17 If 70% of the cost price of an article is equal to 40% of its selling price, what is the profit percentage?

- Ans
- 1. 85%
  - 2. 80%
  - 3. 70%
  - 4. 75%

Q.18 Gaurav marks his goods 50% above the cost price and offers a discount of 30% on the marked price to his customers. What is his percentage gain?

- Ans
- 1. 5%
  - 2. 4%
  - 3. 3%
  - 4. 2%

Q.19 The edges of a rectangular box are in the ratio of 3 : 5 : 8, and its surface area is  $632 \text{ cm}^2$ . What will be the volume of the box?

- Ans
- 1.  $801 \text{ cm}^3$
  - 2.  $990 \text{ cm}^3$
  - 3.  $510 \text{ cm}^3$
  - 4.  $960 \text{ cm}^3$

Q.20 Convert 28% into the form of ratio.

- Ans
- 1. 25 : 7
  - 2. 18 : 7
  - 3. 7 : 25
  - 4. 7 : 18

Q.21 A box filled with gift articles weighs 25 kg. If the weight of the box and the gift articles, respectively, are in the ratio 1 : 9, then the weight of the articles (in grams) is:

- Ans
- 1. 21500
  - 2. 22500
  - 3. 24500
  - 4. 23500

Q.22 If the diameter of the base and curved surface area of a cylinder are 14cm and  $352 \text{ cm}^2$ , respectively, then the total surface area of the cylinder is equal to:

- Ans
- 1.  $660 \text{ cm}^2$
  - 2.  $760 \text{ cm}^2$
  - 3.  $754 \text{ cm}^2$
  - 4.  $654 \text{ cm}^2$

Q.23 Find the average of natural numbers from 1 to 69. (both included)

- Ans
- 1. 37
  - 2. 31
  - 3. 35
  - 4. 33

Q.24 In the given figure, O is the centre of the circle, AE is the diameter and  $\angle AOC = 100^\circ$ .

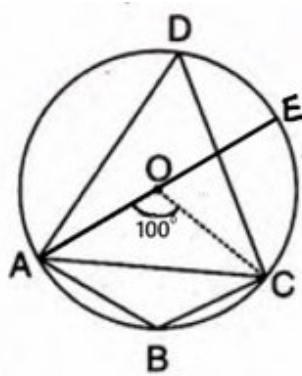

The value of  $\angle CDE + \angle CEA$  is:

- Ans
- 1.  $90^\circ$
  - 2.  $80^\circ$
  - 3.  $60^\circ$
  - 4.  $100^\circ$

Q.25 A and B can complete a piece of work in 15 days, B and C in 30 days and C and A in 45 days. In how many days will they complete the work if they start working together?

- Ans
- 1.  $8\frac{3}{11}$
  - 2.  $11\frac{1}{3}$
  - 3.  $11\frac{2}{3}$
  - 4.  $16\frac{4}{11}$

Section : General Awareness

1. Which of the following statement(s) is/are INCORRECT vis-à-vis Fundamental Duties?
- 1) The 44<sup>th</sup> amendment Act introduced Fundamental duties in the Constitution.
  - 2) Fundamental Duties were expanded by the 86<sup>th</sup> amendment act.
  - 3) Article 51A (a) entails respect its ideals and institutions, national flag and the national anthem.
  - 4) Fundamental Duty obliges parents to provide opportunities for education to their child between 6-14 years of age.

- Ans
- 1. Only 3
  - 2. 2 and 4
  - 3. 2 and 3
  - 4. 1

2. Who among the following Delhi Sultanate rulers took the policy of 'blood and iron' to deal with the Mewati community?

- Ans
- 1. Balban
  - 2. Qutubuddin Aibak
  - 3. Rajiya
  - 4. Iltutmish

3. Which of the following is the second nearest star to Earth?

- Ans
- 1. Delta Velorum
  - 2. Polaris
  - 3. Sirius
  - 4. Proxima Centauri

Q.4 Where is the Save button in Microsoft Word?

- Ans
- 1. Top left corner of a Word window
  - 2. Bottom right corner of a Word window
  - 3. Bottom left corner of a Word window
  - 4. Top right corner of a Word window

Q.5 In which year was the Konkan Railway constructed?

- Ans
- 1. 2008
  - 2. 1988
  - 3. 1998
  - 4. 1978

Q.6 What is the minimum over rate per hour in a test match?

- Ans
- 1. 15 over per hour
  - 2. 13 overs per hour
  - 3. 10 overs per hour
  - 4. 17 overs per hour

Q.7 Which of the following occupies less memory when saving an MS-Word file?

- Ans
- 1. .docm
  - 2. .docc
  - 3. .doc
  - 4. .docx

Q.8 Hemis festival is associated with which of the following religions?

- Ans
- 1. Hinduism
  - 2. Buddhism
  - 3. Sikhism
  - 4. Jainism

Q.9 According to the International Football Association Board (IFAB), which colour must the football goal post be? Ans

- 1. Black
- 2. White
- 3. Red
- 4. Blue

Q.10 Where is the ITC Sangeet Research Academy located?

- Ans
- 1. Indore
  - 2. Kolkata
  - 3. Delhi
  - 4. Bengaluru

Q.11 The Office of the Registrar General and Census Commissioner, India comes under the:

- Ans
- 1. Ministry of Finance
  - 2. Ministry of Home Affairs
  - 3. Ministry of Corporate Affairs
  - 4. Ministry of Rural Development

Q.12 Identify the INCORRECT statement regarding invertebrates from the options given below.

- Ans
- 1. They have open circulatory system as there is no organisation in the distribution.
  - 2. They have radial or bilateral body symmetry.
  - 3. They have a pair of solid nerve cords, situated ventrally and bearing segmentally arranged ganglia.
  - 4. They possess a backbone and an internal skeleton.

Q.13 What is the name of the scheme aimed at conservation of wetlands, which was announced in the Union Budget 2023-

24? Ans  1. Amrit Dharohar

- 2. Dharohar
- 3. Paryavaran Prahari
- 4. Paryavaran Suraksha

Q.14 In February 2023, Shiv Pratap Shukla was appointed governor of which state?

- Ans
- 1. Haryana
  - 2. Himachal Pradesh
  - 3. Tamil Nadu
  - 4. Bihar

Q.15 Which is the natural habitat of the Asiatic Lion in India?

- Ans
- 1. Kaziranga National Park
  - 2. Sundarbans
  - 3. Gir Forest
  - 4. Dudhwa National Park

Q.16 Which of the following contains small droplets of liquid or particles of solid dispersed in a gas?

- Ans
- 1. Gel
  - 2. Vapour
  - 3. Aerosol
  - 4. Foam

Q.17 Ajit Kumar Mohanty took over the charge of Chairman, \_\_\_\_\_, in May 2023.

- Ans
- 1. Bhabha Atomic Research Centre
  - 2. National Human Rights Commission of India
  - 3. National Commission for Backward Classes
  - 4. Atomic Energy Commission

Q.18 Bharat Muni, in his Natya Shastra, categorises musical instruments into four different parts. What is the categorisation of musical instruments by Bharat Muni based on?

- Ans
- 1. Different sounds of the musical instruments
  - 2. The uses of the musical instruments in different occasions, such as wedding, festivals and public gathering
  - 3. Different materials used in the musical instruments
  - 4. The shape of the musical instruments

Q.19 Secularism is a feature of the Indian Constitution, which means:

- Ans
- 1. The State can promote any religion.
  - 2. The State does not promote any religion.
  - 3. The State promotes the religion of the minority community.
  - 4. The State promotes the religion of the majority community.

Q.20 Who introduced the concept of virtual water?

- Ans
- 1. MS Swaminathan
  - 2. Glubler Triplets
  - 3. Norman Borlaug
  - 4. John Anthony Allan

Q.21 Which Governor General of India issued the famous Regulation XVII in 1829, which declared the practice of Sati illegal and punishable by the courts?

- Ans
- 1. Lord Ellenborough
  - 2. Lord William Bentinck
  - 3. Lord Minto
  - 4. Lord Napier

Q.22 Who is the Indian batsman after whom the Ranji Trophy is named?

- Ans
- 1. Ranjit Patel
  - 2. Ranjit Singh Bedi
  - 3. Ranjit Wadekar
  - 4. Ranjit Sinhji

Q.23 Which of the following is the official language of Tripura?

- Ans
- 1. Khasi
  - 2. Garo
  - 3. Kokborak
  - 4. Mizo

Q.24 Which of the following currency note was discarded by the Government of India in November 2016?

- Ans
- 1. ₹100
  - 2. ₹200
  - 3. ₹500
  - 4. ₹2,000

Q.25 Giddha dance is a folk dance of which of the following states?

- Ans
- 1. Manipur
  - 2. Nagaland
  - 3. Punjab
  - 4. Odisha



## Combined Higher Secondary Level Examination 2024 Tier I

Exam Date	04/07/2024
Exam Time	11:45 AM - 12:45 PM
Subject	CHSL Exam 2024 Tier I

### Section : English Language

1. The following sentence has been split into four segments. Identify the segment that contains an **INCORRECT** preposition.  
I am writing to invite you / to give a presentation / for our Jobs and Careers Conference / for engineering graduates.

- Ans
- 1. for engineering graduates
  - 2. I am writing to invite you
  - 3. for our Jobs and Careers Conference
  - 4. to give a presentation

2. Select the grammatically correct sentence.

- Ans
- 1. Ragini plays the guitar melodiously.
  - 2. Ragini plays the guitar melodious.
  - 3. Ragini plays the guitar with a melody.
  - 4. Ragini plays the guitar with melodiousness.

Q.3 The following sentence has been divided into four parts. Identify the part that contains an error.  
(A) I am hearing / (B) that the heat wave / (C) is going to be / (D) worse this year.

- Ans
- 1. B
  - 2. D
  - 3. C
  - 4. A

Q.4 Select the option with the correct use of future tense.

- Ans
- 1. I hope your health is getting better by next week.
  - 2. I hope your health will get better by next week.
  - 3. I hope your health have been getting better by next week.
  - 4. I hope your health is get better by next week.

### Comprehension:

In the following passage, some words have been deleted. Read the passage carefully and select the most appropriate option to fill in each blank.

Once upon a time, there was a man (1)\_\_\_\_\_ used to tell the fortunes of people. One day, he was telling the fortune as usual when a man came to him and said, "Somebody (2)\_\_\_\_\_ broken the door of your house and has stolen many valuables. Go home at once!" The fortune teller was (3)\_\_\_\_\_ shocked to hear the news. He could not utter a word out of shock. He just ran to his house as fast as he could. He was in such a hurry that he left all his things behind. Now, one of his customers saw him rushing and (4)\_\_\_\_\_, "Every day he (5)\_\_\_\_\_ the fortunes of so many people but today he could not see his own future!" The fortune teller felt very embarrassed.

SubQuestion No : 5

Q.5 Select the most appropriate option to fill in blank number 1.

- Ans
- 1. whose
  - 2. whom
  - 3. by whom
  - 4. who

**Comprehension:**

In the following passage, some words have been deleted. Read the passage carefully and select the most appropriate option to fill in each blank.

Once upon a time, there was a man (1)\_\_\_\_\_used to tell the fortunes of people. One day, he was telling the fortune as usual when a man came to him and said, "Somebody (2)\_\_\_\_\_broken the door of your house and has stolen many valuables. Go home at once!" The fortune teller was (3)\_\_\_\_\_shocked to hear the news. He could not utter a word out of shock. He just ran to his house as fast as he could. He was in such a hurry that he left all his things behind. Now, one of his customers saw him rushing and (4)\_\_\_\_\_, "Every day he (5)\_\_\_\_\_the fortunes of so many people but today he could not see his own future!" The fortune teller felt very embarrassed.

**SubQuestion No : 6****Q.6 Select the most appropriate option to fill in blank number 2.**

- Ans
- 1. shall have
  - 2. had
  - 3. have
  - 4. has

**Comprehension:**

In the following passage, some words have been deleted. Read the passage carefully and select the most appropriate option to fill in each blank.

Once upon a time, there was a man (1)\_\_\_\_\_used to tell the fortunes of people. One day, he was telling the fortune as usual when a man came to him and said, "Somebody (2)\_\_\_\_\_broken the door of your house and has stolen many valuables. Go home at once!" The fortune teller was (3)\_\_\_\_\_shocked to hear the news. He could not utter a word out of shock. He just ran to his house as fast as he could. He was in such a hurry that he left all his things behind. Now, one of his customers saw him rushing and (4)\_\_\_\_\_, "Every day he (5)\_\_\_\_\_the fortunes of so many people but today he could not see his own future!" The fortune teller felt very embarrassed.

**SubQuestion No : 7****Q.7 Select the most appropriate option to fill in blank number 3.**

- Ans
- 1. so less
  - 2. so more
  - 3. many
  - 4. quite

**Comprehension:**

In the following passage, some words have been deleted. Read the passage carefully and select the most appropriate option to fill in each blank.

Once upon a time, there was a man (1)\_\_\_\_\_used to tell the fortunes of people. One day, he was telling the fortune as usual when a man came to him and said, "Somebody (2)\_\_\_\_\_broken the door of your house and has stolen many valuables. Go home at once!" The fortune teller was (3)\_\_\_\_\_shocked to hear the news. He could not utter a word out of shock. He just ran to his house as fast as he could. He was in such a hurry that he left all his things behind. Now, one of his customers saw him rushing and (4)\_\_\_\_\_, "Every day he (5)\_\_\_\_\_the fortunes of so many people but today he could not see his own future!" The fortune teller felt very embarrassed.

**SubQuestion No : 8****Q.8 Select the most appropriate option to fill in blank number 4.**

- Ans
- 1. comments
  - 2. commented
  - 3. commenting
  - 4. comment

**Comprehension:**

In the following passage, some words have been deleted. Read the passage carefully and select the most appropriate option to fill in each blank.

Once upon a time, there was a man (1)\_\_\_\_\_used to tell the fortunes of people. One day, he was telling the fortune as usual when a man came to him and said, "Somebody (2)\_\_\_\_\_broken the door of your house and has stolen many valuables. Go home at once!" The fortune teller was (3)\_\_\_\_\_shocked to hear the news. He could not utter a word out of shock. He just ran to his house as fast as he could. He was in such a hurry that he left all his things behind. Now, one of his customers saw him rushing and (4)\_\_\_\_\_, "Every day he (5)\_\_\_\_\_the fortunes of so many people but today he could not see his own future!" The fortune teller felt very embarrassed.

**SubQuestion No : 9****Q.9 Select the most appropriate option to fill in blank number 5.**

- Ans
- 1. tell
  - 2. tells
  - 3. telling
  - 4. told

Q.10 Select the most appropriate synonym of the given word.

Lousy

- Ans
- 1. Praiseworthy
  - 2. Moral
  - 3. Funny
  - 4. Pitiful

Q.11 Select the most appropriate ANTONYM of the given word.

Agile

- Ans
- 1. Active
  - 2. Apathetic
  - 3. Energetic
  - 4. Sluggish

Q.12 Select the INCORRECTLY spelt word in the given sentence.  
The west Africans have a heritage of producing sculpture using wax and bronze.

- Ans
- 1. Sculpture
  - 2. Bronze
  - 3. Heritage
  - 4. Producing

Q.13 Select the most appropriate option that can substitute the underlined word in the following sentence.  
His flight departs in 5:00 pm.

- Ans
- 1. of
  - 2. for
  - 3. at
  - 4. from

Q.14 Select the option that will most suitably substitute the underlined part of the given sentence.  
I gave my best dress to her on condition that she return it the very next day in a clean condition.

- Ans
- 1. on the condition that she would return
  - 2. on the condition that she return
  - 3. on condition that she returned
  - 4. on the conditions that she had return

Q.15 Select the most appropriate option that can substitute the underlined segment in the given sentence.  
The novel highlights the place of the endangered species in the rainforest.

- Ans
- 1. prowess
  - 2. position
  - 3. plight
  - 4. perspective

Q.16 Select the most appropriate option that can substitute the underlined segment in the given sentence.  
The boy watched a sci-fi movie in the lieu of playing in the game zone.

- Ans
- 1. in lieu of play
  - 2. in lieu off playing
  - 3. in lieu of playing
  - 4. on lieu of playing

Q.17 Identify the INCORRECTLY spelt word in the following sentence and select its correct spelling from the given options.  
The boy found the project to be a peice of cake because it was incredibly easy.

- Ans
- 1. piece
  - 2. incredibly
  - 3. foound
  - 4. praject

Q.18 Select the most appropriate ANTONYM of the underlined word in the following sentence.  
There is also an increase in juvenile delinquency.

- Ans
- 1. Teenage
  - 2. Adult
  - 3. Puerile
  - 4. Minor

Q.19 Fill in the blank using the correct collocation.  
We need to \_\_\_\_\_ a decision on the housing project tomorrow morning.

- Ans
- 1. make
  - 2. draw
  - 3. build
  - 4. frame

Q.20 Select the most appropriate ANTONYM of the given word.  
Alluring

- Ans
- 1. Enticing
  - 2. Glamourous
  - 3. Repulsive
  - 4. Fascinating

Q.21 Select the most appropriate synonym that can replace the underlined word in the given sentence.

It did not take her very long to ascend to power.

- Ans
- 1. grab
  - 2. climb
  - 3. reach
  - 4. arise

Q.22 Select the most appropriate option that can substitute the underlined part in the following sentence.  
My entire family left me in the lurch when I went to them after I divorced my husband.

- Ans
- 1. refused to help me in my distress
  - 2. blamed only me for my failure
  - 3. scorned me for committing mistakes
  - 4. attempted to harass me

Q.23 Select the most appropriate meaning of the underlined idiom.  
Prakash could not make up his mind about what to do with the project.

- Ans
- 1. Abandon
  - 2. Think
  - 3. Abide
  - 4. Decide

**Q.24** Select the most appropriate ANTONYM of the given word.  
Resourceful

- Ans**
- 1. Incompetent
  - 2. Ingenious
  - 3. Immaculate
  - 4. Impeccable

**Q.25** Select the most appropriate synonym of the given word.

**Peculiar**

- Ans**
- 1. Revolutionary
  - 2. Strange
  - 3. Frequent
  - 4. Usual

Section : General Intelligence

**Q.1** Select the set in which the numbers are related in the same way as are the numbers of the following sets.  
(NOTE: Operations should be performed on the whole numbers, without breaking down the numbers into its constituent digits. E.g., 13 – Operations on 13 such as adding/subtracting/multiplying etc. to 13 can be performed. Breaking down 13 into 1 and 3 and then performing mathematical operations on 1 and 3 is not allowed.)

(3, 12, 26)  
(7, 9, 53)

- Ans**
- 1. (7, 5, 25)
  - 2. (4, 9, 16)
  - 3. (12, 4, 114)
  - 4. (5, 15, 45)

Q.2

A paper is folded and cut as shown below. How will it appear when unfolded?

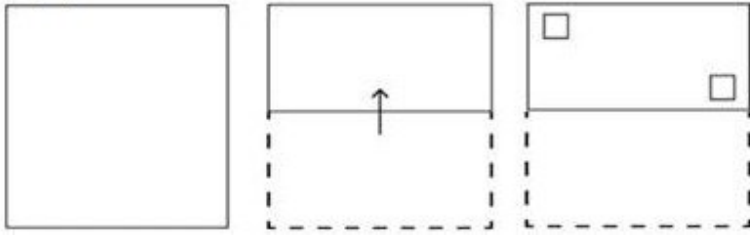

Ans

X 1.

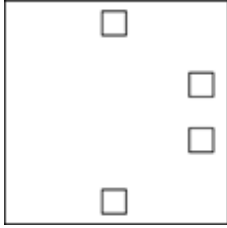

✓ 2.

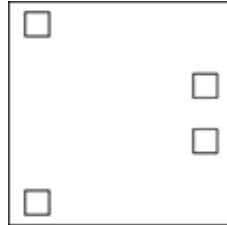

X 3.

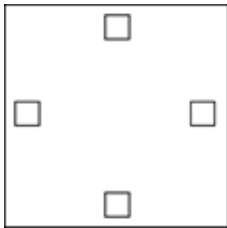

X 4.

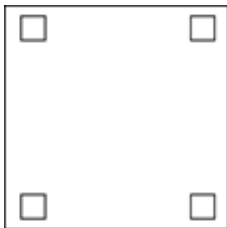

Adda247 Marathi

Q.3 Select the option figure in which the given figure is embedded as its part (rotation is NOT allowed).

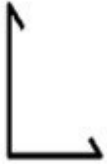

Ans

✗ 1.



✗ 2.



✗ 3.



✓ 4.

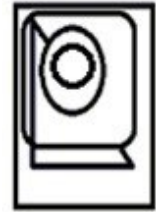

Q.4 Which two numbers should be interchanged to make the given equation correct?

$$17 \times 7 + (21 \div 3) \times 5 - 28 + 34 = 72$$

(NOTE: Numbers must be interchanged and not the constituent digits e.g. if 2 and 3 are to be interchanged in the equation  $43 \times 3 + 4 \div 2$ , then interchanged equation is  $43 \times 2 + 4 \div 3$ )

Ans ✓ 1. 7 and 3

✗ 2. 17 and 28

✗ 3. 21 and 28

✗ 4. 5 and 7

Q.5 How many triangles are there in the given figure?

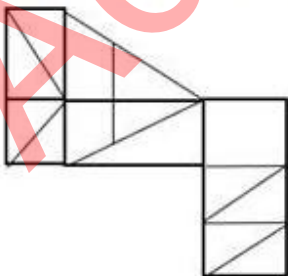

Ans ✗ 1. 12

✗ 2. 9

✓ 3. 16

✗ 4. 14

Q.6 If 'A' stands for '+', 'B' stands for '×', 'C' stands for '÷' and 'D' stands for '−', what will come in place of the question mark (?) in the following equation?

$$16 \text{ B } 8 \text{ D } 51 \text{ A } 3 \text{ C } 57 = ?$$

- Ans
- 1. 188
  - 2. 168
  - 3. 128
  - 4. 148

Q.7 Select the option in which the given figure is embedded. (Rotation is NOT allowed).

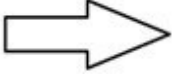

- Ans
- 1.
  - 2.
  - 3.
  - 4.

Q.8 Which of the following numbers will replace the question mark (?) in the given series?

93    111    139    157    185    203    ?

- Ans
- 1. 227
  - 2. 211
  - 3. 215
  - 4. 231

Q.9 In a certain code language, 'hands are dirty' is written as 'ca bx vp' and 'dirty things flies' is written as 'by vp cb'. How is 'dirty' written in the given language?

- Ans
- 1. by
  - 2. cb
  - 3. bx
  - 4. vp

Q.10 11 is related to 121 by certain logic. Following the same logic, 21 is related to 441. To which of the following is 31 related, following the same logic?

(NOTE: Operations should be performed on the whole numbers, without breaking down the numbers into its constituent digits. E.g. 13 - Operations on 13 such as adding/subtracting/multiplying etc. to 13 can be performed. Breaking down 13 into 1 and 3 and then performing mathematical operations on 1 and 3 is not allowed.)

- Ans
- 1. 356
  - 2. 960
  - 3. 961
  - 4. 428



Q.11 Select the option figure in which the given figure is embedded as its part (rotation is NOT allowed).



Ans

✗ 1.

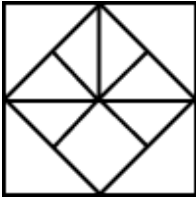

✓ 2.

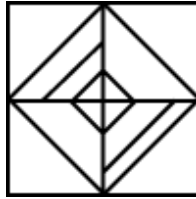

✗ 3.



✗ 4.

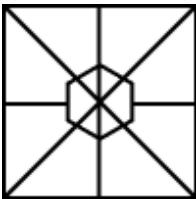

Q.12 In a certain code language  
A + B means 'A is the mother of B'  
A - B means 'A is the sister of B'  
A × B means 'A is the wife of B'  
A ÷ B means 'A is the son of B'  
Based on the above, how is Z related to W if 'Z × Y ÷ X - V + W'?

Ans

✓ 1. Mother's sister's son's wife

✗ 2. Mother's sister's son's daughter

✗ 3. Mother's brother's son's wife

✗ 4. Mother's sister's daughter

Q.13 Select the option in which the given figure is embedded (rotation is not allowed).

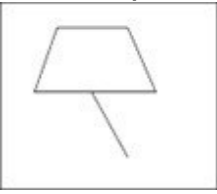

Ans

✓ 1.

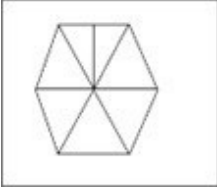

✗ 2.

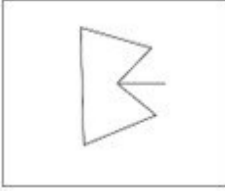

✗ 3.

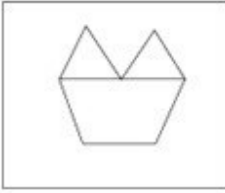

✗ 4.

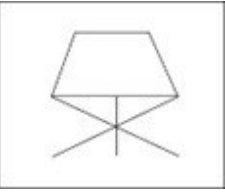

Adda247 Marathi

Q.14 Which figure should replace the question mark (?) if the following figure series were to be continued?

3	T	A	Z	6	3	3	A	Z	T	6	3	
	6			T			6			A		?
Z		=	=		A	T		=	=		Z	

Ans

✗ 1.

3	Z	A
	T	
6		=

✗ 2.

3	T	6
	Z	
A		=

✗ 3.

Z	=	T
	6	
A		3

✓ 4.

3	Z	T
	6	
A		=

Q.15 Three of the following four are alike in a certain way and thus form a group. Which is the one that does NOT belong to that group?

(Note: The odd one out is not based on the number of consonants/vowels or their position in the letter cluster.)

Ans

✗ 1. BEH

✗ 2. NQT

✓ 3. KMP

✗ 4. RUX

Q.16 If 'E' stands for '+', 'U' stands for 'x', 'A' stands for '+' and 'C' stands for '-', what will come in place of the question mark (?) in the following equation?

16 A 24 C 30 E 15 U 9 = ?

Ans

✓ 1. 22

✗ 2. 32

✗ 3. 66

✗ 4. 78

Q.17 AQLZ is related to SIDR in a certain way based on the English alphabetical order. In the same way, CPDV is related to UHVN. To which of the following is EBRY related, following the same logic?

- Ans
- 1. WQJT
  - 2. WQTJ
  - 3. WTJQ
  - 4. WTQJ

Q.18 If 23 January 2002 was Wednesday, then what was the day of the week on 26 January 2007?

- Ans
- 1. Friday
  - 2. Sunday
  - 3. Saturday
  - 4. Monday

Q.19 What should come in place of the question mark (?) in the given series based on the English alphabetical order? MKH, PNK, SQN, VTQ, ?

- Ans
- 1. YWT
  - 2. WTY
  - 3. WYT
  - 4. YTW

Q.20 If 26 November 2013 was Tuesday, then what was the day of the week on 29 November 2018?

- Ans
- 1. Wednesday
  - 2. Friday
  - 3. Saturday
  - 4. Thursday

Q.21 Which letter-cluster will replace the question mark (?) to complete the given series? UTHS, VRKO, ?, XNQG, YLTC

- Ans
- 1. WPNK
  - 2. WONJ
  - 3. WPMN
  - 4. TONK

Q.22 What should come in place of the question mark (?) in the given series?

77, 79, 83, 89, 97, ?

- Ans
- 1. 106
  - 2. 107
  - 3. 105
  - 4. 108

**Q.23** Select the pair which follows the same pattern as that followed by the two set of pairs given below. Both pairs follow the same pattern.

FJK : KOP

MQR : RVW

- Ans**
- 1. GMN : FLM
  - 2. ADE : ZWV
  - 3. PRS : SRP
  - 4. JMP : ORU

**Q.24** Three statements are followed by conclusions numbered I, II. You have to consider these statements to be true, even if they seem to be at variance with commonly known facts. Decide which of the given conclusions logically follow/s from the given statement.

**Statements:**

All space is wind.

Some wind is earth.

Some fire is earth.

**Conclusion (I):** All earth is space.

**Conclusion (II):** Some wind is fire.

- Ans**
- 1. Neither conclusion (I) nor (II) follows.
  - 2. Only conclusion (I) follows.
  - 3. Only conclusion (II) follows.
  - 4. Both conclusions (I) and (II) follow.

**Q.25** What should come in place of the question mark (?) in the given series?

77, 88, 101, 116, ?

- Ans**
- 1. 331
  - 2. 133
  - 3. 313
  - 4. 131

Q.1 Study the given bar-graph and answer the question that follows.

The bar-graph shows the production of refrigerators (in thousand) by five different companies A, B, C, D and E during 2004 to 2007.

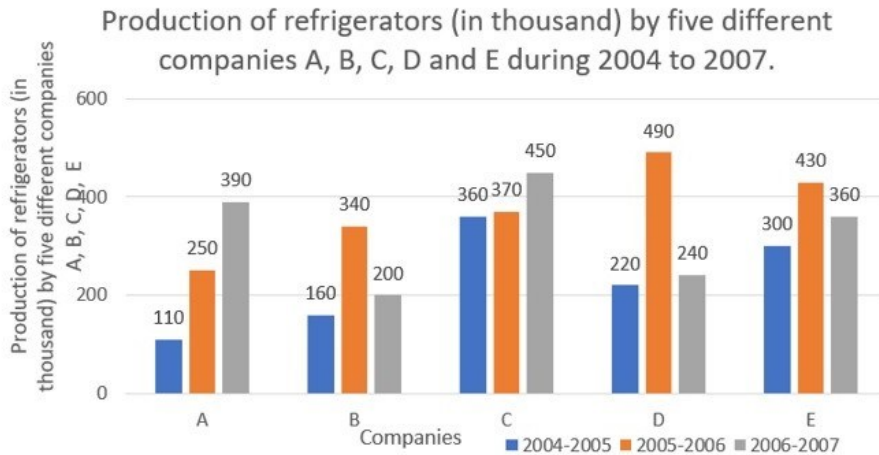

What is the ratio of the average production of the refrigerators by companies A, B and E taken together for the year 2004-2005 to the average production of the refrigerators by companies C and D taken together for the year 2005-2006?

- Ans
- 1. 41:19
  - 2. 19:41
  - 3. 19:43
  - 4. 43:19

Q.2 Arun and Bhaskar run a race of 3 km. First, Arun gives Bhaskar a head start of 400 m and beats him by 30 seconds. While coming back, Arun gives Bhaskar a lead of 2.5 minutes and gets beaten by 500 m. What is the difference between the times in minutes in which Arun and Bhaskar can run the race for one side separately?

- Ans
- 1. 3 min
  - 2. 1.5 min
  - 3. 2.5 min
  - 4. 2 min

Q.3 The value of  $10 + 3\frac{3}{5} \div \left[ 2\frac{2}{3} \div \left\{ 7\frac{1}{6} - \left( 2\frac{1}{2} + \frac{2}{3} \right) \right\} \right]$  is equal to:

- Ans
- 1.  $\frac{77}{5}$
  - 2.  $\frac{5}{77}$
  - 3.  $\frac{55}{27}$
  - 4.  $\frac{27}{55}$

Q.4 A can complete a piece of work in 20 days and B can complete the same work in 10 days. With the help of C, working together they completed the work in 5 days. The number of days in which C alone can complete the work is:

- Ans
- 1. 25
  - 2. 10
  - 3. 15
  - 4. 20

Q.5 The radius of a sphere is increased by 25%. What is the increase per cent in surface area?

- Ans
- 1. 56.25%
  - 2. 36.45%
  - 3. 25.25%
  - 4. 15.55%

Q.6 In  $\triangle ABC$ , P and Q are the middle points of the sides AB and AC, respectively. R is a point on the segment PQ such that PR: RQ = 1:5. If PR = 6 cm, then BC = \_\_\_\_\_.

- Ans
- 1. 70 cm
  - 2. 66 cm
  - 3. 68 cm
  - 4. 72 cm

Q.7 What is the value of  $\frac{1}{\sin^4(90^\circ - 2\alpha)} + \frac{1}{\cos^2(90^\circ - 2\alpha) - 1}$ ?

- Ans
- 1.  $\sin^2 2\alpha + \tan^2 2\alpha$
  - 2.  $\sec^2 2\alpha \tan^2 2\alpha$
  - 3.  $\sec^2 2\alpha + \cot^2 2\alpha$
  - 4.  $\cos^2 2\alpha \cot^2 2\alpha$

Q.8 A company sells goods at a markup of 25% above the cost price. During a sale, the company offers a 10% discount on the marked price. If the customer pays ₹540 after the discount, then what was the original cost price of the goods?

- Ans
- 1. ₹460
  - 2. ₹470
  - 3. ₹480
  - 4. ₹450

Q.9 Study the given table and select the most appropriate option to fill in the blanks.

Consider the data of sales of products, A, B and C, by three companies, X, Y and Z, in the table given below.

Product → Company ↓	A	B	C
X	2750	3250	2250
Y	2500	3000	1750
Z	3500	3150	2400

The highest average sale per company is for the product \_\_\_\_\_ and the lowest average sale per product is for the company \_\_\_\_\_.

- Ans
- 1. B; Z
  - 2. A; Y
  - 3. A; X
  - 4. B; Y

Q.10 Rahul spends 70% of his income. His income increased by 15% and his expenditure increased by 7.5%. What is the percentage increase in his savings?

- Ans
- 1. 25.5%
  - 2. 30.5%
  - 3. 50%
  - 4. 32.5%

Q.11 Kamlesh offers the following two discount schemes to his customers on the sale of an article:

- (i) Two successive discounts of 25% and 5%
- (ii) Two successive discounts of 20% and 10%

What is the difference between the selling price (in ₹) of the article under these two discount schemes if its marked price is ₹1,000?

- Ans
- 1. 7.0
  - 2. 7.5
  - 3. 6.5
  - 4. 8.0



Q.12 The given table shows the number of candidates who have appeared, qualified and been selected in an examination from two states A and B over the years 2001 to 2005.

Year	State A			State B		
	Applied	Qualified	Selected	Applied	Qualified	Selected
2001	8000	850	94	8200	680	85
2002	4800	500	48	6800	600	70
2003	7500	640	82	6500	525	65
2004	9500	850	90	7800	720	84
2005	9000	800	70	5700	485	60

In the year 2001, the percentage of candidates who were selected over the candidates who applied in State A is:

- Ans
- 1. 1.165%
  - 2. 1.175%
  - 3. 1.155%
  - 4. 1.185%

Q.13 What is the curved surface area of cylinder whose radius is 3cm and height is 14cm? (Take  $\pi = \frac{22}{7}$ )

- Ans
- 1. 262 cm<sup>2</sup>
  - 2. 264 cm<sup>2</sup>
  - 3. 263 cm<sup>2</sup>
  - 4. 261 cm<sup>2</sup>

Q.14 If two numbers are each divided by the same divisor, then the remainders are 6 and 7, respectively. If the sum of the two numbers be divided by the same divisor, then the remainder is 5. The divisor is:

- Ans
- 1. 6
  - 2. 8
  - 3. 13
  - 4. 4

Q.15 Last year, Ranjan's monthly salary was ₹34,500 and this year his monthly salary is ₹38,640. What is the percentage increase in Ranjan's monthly salary this year over his monthly salary last year?

- Ans
- 1. 15%
  - 2. 12%
  - 3. 20%
  - 4. 13%

Q.16 Find the fourth proportional to 2, 6, 8.

- Ans
- 1. 12
  - 2. 48
  - 3. 36
  - 4. 24

Q.17 10 years ago, a man's age was 5 times of his son's age. 2 years hence, twice his age will be equal to 4 times the age of his son. What is the present age (in years) of the son?

- Ans
- 1. 20
  - 2. 16
  - 3. 18
  - 4. 14

Q.18

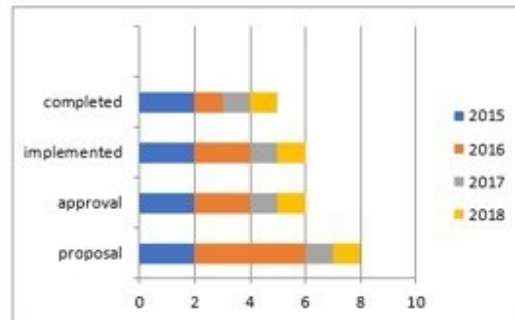

A company starts constructing buildings for a college. The constructions have 4 stages.

1. buildings proposals
2. proposals approval
3. constructions implemented
4. buildings completed

The above 3D-bar graph indicates the status of constructions for 4 years 2015 to 2018.

The X-axis scale 0, 2, 4, 6, 8, 10 indicates 0, 20%, 40%, 60%, 80%, 100%.

Study the bar graph carefully and answer the following question.

Find the total percentage of buildings completed during the total period, 2015 to 2018.

- Ans
- 1. 40%
  - 2. 50%
  - 3. 30%
  - 4. 60%

Q.19 Find the area of a rhombus whose diagonals are of lengths 10 cm and 8.2 cm.

- Ans
- 1.  $43 \text{ cm}^2$
  - 2.  $41 \text{ cm}^2$
  - 3.  $40 \text{ cm}^2$
  - 4.  $42 \text{ cm}^2$

Q.20 The centers of two circles of radii 25 cm and 35 cm are 80 cm apart. What is the ratio of the lengths of the transverse common tangent to the direct common tangent to these circles?

Ans

✓ 1.  $2 : 3$

✗ 2.  $\sqrt{7} : 3$

✗ 3.  $3\sqrt{7} : 2$

✗ 4.  $2 : \sqrt{7}$

Q.21 In right triangle ABC with right angle at C, M is the mid-point of hypotenuse AB. C is joined to M and produced to a point D, such that  $DM = CM$ . Point D is joined to B. If  $CD = 10$  cm, and  $BD = 6$  cm, find the value of CM.

Ans

✗ 1. 8 cm

✓ 2. 5 cm

✗ 3. 9.5 cm

✗ 4. 11.4 cm

Q.22 The measures of the three angles of a triangle are such that the smallest angle measures  $42^\circ$  less than the greatest angle, while the measure of the remaining angle is  $24^\circ$  more than the measure of the smallest angle. Find the measure of the smallest angle of the triangle.

Ans

✗ 1.  $42^\circ$

✗ 2.  $40^\circ$

✓ 3.  $38^\circ$

✗ 4.  $36^\circ$

Q.23 In a college, the average weight of 40 boys in a section among 72 students is 33 kg and that of the remaining students is 15 kg. What is the average weight of all the students in the section?

Ans

✗ 1. 18 kg

✓ 2. 25 kg

✗ 3. 24 kg

✗ 4. 22 kg

Q.24 How much time (in years) will it take for an amount of ₹4,50,000 to yield ₹45,000 as simple interest at a 5% per annum rate of interest?

Ans

✗ 1. 5

✗ 2. 4

✓ 3. 2

✗ 4. 3

Q.25 The cost of rice is increased by 25% but its consumption is decreased by 30%. Find the percentage increase or decrease in the expenditure of money.

Ans

✗ 1. Increase  $12\frac{1}{2}\%$

✗ 2. Increase  $13\frac{1}{3}\%$

✓ 3. Decrease  $12\frac{1}{2}\%$

✗ 4. Decrease  $13\frac{1}{3}\%$

Q.1 How many fundamental duties were recommended to be inserted in the Indian Constitution by the Swarna Singh Committee?

- Ans
- 1. 7
  - 2. 6
  - 3. 8
  - 4. 9

2. Parkash Singh Badal passed away in April 2023. He served as Chief Minister of \_\_\_\_\_ for five times.

- Ans
- 1. Bihar
  - 2. Punjab
  - 3. Himachal Pradesh
  - 4. Haryana

Q.3 Dussehra festival is celebrated in which of the following Hindu months?

- Ans
- 1. Chaitra
  - 2. Ashwin
  - 3. Vaisakha
  - 4. Ashadha

Q.4 Which feature in MS Word allows you to see a document's layout and formatting as it will appear when printed?

- Ans
- 1. Draft View
  - 2. Screen View
  - 3. Print Preview
  - 4. Reading View

Q.5 In whose ashram did the Beatles compose rock music in 1968 influenced by classical music?

- Ans
- 1. Maharshi Mahesh Yogi Ashram
  - 2. Osho Rajnish Ashram
  - 3. Pandit Ravishankar Ashram
  - 4. Maharshi Aurobindo Ashram

Q.6 What is the standard weight of hammer for women in the hammer throw event?

- Ans
- 1. 6 kg
  - 2. 8 kg
  - 3. 4 kg
  - 4. 5 kg

Q.7 Brihadiswara Temple of Tanjore was built by which of the following Chola emperors?

- Ans
- 1. Rajendra I
  - 2. Raja Raja Chola
  - 3. Vijayalaya
  - 4. Chamunda Raya

Q.8 In which of the following years did the Constitution (One Hundredth Amendment) Act come into force?

- Ans
- 1. 2001
  - 2. 2020
  - 3. 2015
  - 4. 2009

**Q.9** On 12 September 2002, ISRO launched the Kalpana-1 satellite using the Polar Satellite Launch Vehicle. What is the application of this satellite?

- Ans**
- 1. Disaster management system
  - 2. Climate & environment communication
  - 3. Earth observation
  - 4. Planetary observation

**Q.10** Which of the following writs in Latin means 'we command'?

- Ans**
- 1. Prohibition
  - 2. Habeas corpus
  - 3. Quo-warranto
  - 4. Mandamus

**Q.11** What is the primary aim of Regional Rural Banks in India?

- Ans**
- 1. Development of rural economy
  - 2. Development of urban economy
  - 3. Development of semi-urban economy
  - 4. Development of metropolitan economy

**Q.12** In which state is the Nanda Devi Biosphere Reserve located?

- Ans**
- 1. Uttarakhand
  - 2. Himachal Pradesh
  - 3. Assam
  - 4. Odisha

**Q.13** Which was the first programmable general purpose computer in the world?

- Ans**
- 1. Pascaline
  - 2. Napier's bones
  - 3. ENIAC
  - 4. Mark I

**Q.14** Which country's national game is Chinlone (Caneball)?

- Ans**
- 1. Afghanistan
  - 2. Bhutan
  - 3. China
  - 4. Myanmar

**Q.15** Which Act was enacted by the British which regulated the manufacture, sale, possession and transport of firearms?

- Ans**
- 1. Indian Arms Act, 1878
  - 2. The Arm Rules, 1839
  - 3. The Arms Act, 1857
  - 4. The Firearms Act, 1871

**Q.16** Which classical dance was introduced by the great Vaishnava saint and reformer of Assam?

- Ans**
- 1. Kuchipudi
  - 2. Odissi
  - 3. Kathak
  - 4. Sattriya

Q.17 India hosted Men's Hockey World Cup in 2023 at:

- Ans
- 1. Bhubaneswar and Rourkela
  - 2. Patna and Gaya
  - 3. Nashik and Nagpur
  - 4. Amritsar and Bathinda

Q.18 What does SAARC stand for?

- Ans
- 1. South Asian Association of Regional Cartography
  - 2. South Asian Association for Regional Cooperation
  - 3. South Asian Association of Regional Climate change
  - 4. South Asian Association of Regional Corporation

Q.19 The Atal Tunnel has been built by Border Road Organisation at an altitude of 3000 metres. Which places are connected by this tunnel?

- Ans
- 1. Shimla to Ladakh
  - 2. Shimla to Srinagar
  - 3. Manali to Shimla
  - 4. Manali to Lahaul-Spiti

Q.20 Which type of system did the leaders of independent India decide to adopt?

- Ans
- 1. A system that would promote the welfare of the government
  - 2. A system that would promote the welfare of few rather than all
  - 3. A system that would promote the welfare of all rather than a few
  - 4. A system that would promote the welfare of private enterprises

Q.21 The 9th Men's ICC T20 World Cup Cricket 2024 will be hosted by which of the following countries?

- Ans
- 1. Canada and USA
  - 2. India and Sri Lanka
  - 3. West Indies and USA
  - 4. India and Bangladesh

Q.22 In February 2023, PARAKH became the First National Assessment Regulator. What does R stand for in PARAKH?

- Ans
- 1. Related
  - 2. Report
  - 3. Review
  - 4. Recall

Q.23 In which year did Wilhelm Johannsen coin the term 'gene' to describe the Mendelian units of heredity?

- Ans
- 1. 1909
  - 2. 1900
  - 3. 1920
  - 4. 1910

Q.24 Electrochemical cell is a device which converts chemical energy into electrical energy in a/an \_\_\_\_\_.

- Ans
- 1. oxidation reaction
  - 2. reduction reaction
  - 3. direct redox reaction
  - 4. indirect redox reaction

Q.25 In classical Carnatic music, tempo is called as \_\_\_\_\_.

Ans  1. gita

2. laya

3. achala

4. padam

Adda247 Marathi

## Combined Higher Secondary Level Examination 2024 Tier I

Exam Date	04/07/2024
Exam Time	2:30 PM - 3:30 PM
Subject	CHSL Exam 2024 Tier I

### Section : English Language

1. The following sentence has been split into four segments. Identify the segment that contains a grammatical error.

This artwork / are a wonderful example / of the period's vogue / for realistic style.

- Ans
- 1. This artwork
  - 2. of the period's vogue
  - 3. for realistic style
  - 4. are a wonderful example

2. The following sentence has been divided into four parts. Identify the part that contains an error. Pratigya arrived / to the / railway station / five hours early.

- Ans
- 1. railway station
  - 2. Pratigya arrived
  - 3. to the
  - 4. five hours early.

3. Identify the error in the following sentence and select the option with the correct use of the phrasal verb. Prateek was planning to ask Shreya for a favour. But he could not muster up the courage. So, he blacked out.

- Ans
- 1. Prateek was planning to ask Shreya for a favour. But he could not muster up the courage. So, he broke in.
  - 2. Prateek was planning to ask Shreya for a favour. But he could not muster up the courage. So, he chickened out.
  - 3. Prateek was planning to ask Shreya for a favour. But he could not muster up the courage. So, he checked out.
  - 4. Prateek was planning to ask Shreya for a favour. But he could not muster up the courage. So, he turned down.

- Q.4 The following sentence has been split into four segments. Identify the segment that contains a grammatical error.

The companies were / giving in the prizes / to attract customers / during the festive season.

- Ans
- 1. The companies were
  - 2. giving in the prizes
  - 3. during the festive season
  - 4. to attract customers



**Comprehension:**

In the following passage, some words have been deleted. Read the passage carefully and select the most appropriate option to fill in each blank.

Famines were (1) \_\_\_\_\_ during the period of British rule due to many reasons (2) \_\_\_\_\_ unemployment following import of machine-made goods from Britain, overexploitation of farmers and (3) \_\_\_\_\_ access to food. India suffered two very severe droughts in 1965 and 1966. India achieved (4) \_\_\_\_\_ in food grains by the year 1976 through the implementation of the seed-water-fertiliser-led (5) \_\_\_\_\_. The country is no longer exposed to real famines. However, lack of purchasing power continues to haunt people in some parts of the country.

**SubQuestion No : 5**

**Q.5** Select the most appropriate option to fill in blank number 1.

- Ans**
- 1. caused
  - 2. excruciated
  - 3. paused
  - 4. discouraged

**Comprehension:**

In the following passage, some words have been deleted. Read the passage carefully and select the most appropriate option to fill in each blank.

Famines were (1) \_\_\_\_\_ during the period of British rule due to many reasons (2) \_\_\_\_\_ unemployment following import of machine-made goods from Britain, overexploitation of farmers and (3) \_\_\_\_\_ access to food. India suffered two very severe droughts in 1965 and 1966. India achieved (4) \_\_\_\_\_ in food grains by the year 1976 through the implementation of the seed-water-fertiliser-led (5) \_\_\_\_\_. The country is no longer exposed to real famines. However, lack of purchasing power continues to haunt people in some parts of the country.

**SubQuestion No : 6**

**Q.6** Select the most appropriate option to fill in blank number 2.

- Ans**
- 1. excluding large-scale
  - 2. excluding small-scale
  - 3. including small-scale
  - 4. including large-scale

**Comprehension:**

In the following passage, some words have been deleted. Read the passage carefully and select the most appropriate option to fill in each blank.

Famines were (1) \_\_\_\_\_ during the period of British rule due to many reasons (2) \_\_\_\_\_ unemployment following import of machine-made goods from Britain, overexploitation of farmers and (3) \_\_\_\_\_ access to food. India suffered two very severe droughts in 1965 and 1966. India achieved (4) \_\_\_\_\_ in food grains by the year 1976 through the implementation of the seed-water-fertiliser-led (5) \_\_\_\_\_. The country is no longer exposed to real famines. However, lack of purchasing power continues to haunt people in some parts of the country.

**SubQuestion No : 7**

**Q.7** Select the most appropriate option to fill in blank number 3.

- Ans**
- 1. basic
  - 2. restricted
  - 3. unlimited
  - 4. inflated

**Comprehension:**

In the following passage, some words have been deleted. Read the passage carefully and select the most appropriate option to fill in each blank.

Famines were (1) \_\_\_\_\_ during the period of British rule due to many reasons (2) \_\_\_\_\_ unemployment following import of machine-made goods from Britain, overexploitation of farmers and (3) \_\_\_\_\_ access to food. India suffered two very severe droughts in 1965 and 1966. India achieved (4) \_\_\_\_\_ in food grains by the year 1976 through the implementation of the seed-water-fertiliser-led (5) \_\_\_\_\_. The country is no longer exposed to real famines. However, lack of purchasing power continues to haunt people in some parts of the country.

**SubQuestion No : 8**

**Q.8** Select the most appropriate option to fill in blank number 4.

- Ans**
- 1. goal
  - 2. incompetency
  - 3. success
  - 4. self-sufficiency

**Comprehension:**

In the following passage, some words have been deleted. Read the passage carefully and select the most appropriate option to fill in each blank.

Famines were (1) \_\_\_\_\_ during the period of British rule due to many reasons (2) \_\_\_\_\_ unemployment following import of machine-made goods from Britain, overexploitation of farmers and (3) \_\_\_\_\_ access to food. India suffered two very severe droughts in 1965 and 1966. India achieved (4) \_\_\_\_\_ in food grains by the year 1976 through the implementation of the seed-water-fertiliser-led (5) \_\_\_\_\_. The country is no longer exposed to real famines. However, lack of purchasing power continues to haunt people in some parts of the country.

**SubQuestion No : 9**

**Q.9** Select the most appropriate option to fill in blank number 5.

- Ans**
- 1. Blue Revolution
  - 2. Pink Revolution
  - 3. Green Revolution
  - 4. White Revolution

**Q.10** Read the sentence carefully and select the most appropriate option to substitute the underlined part.

The revolt of the labourers will be considered as an epoch in the world history.

- Ans**
- 1. unpopular measure
  - 2. hostile event
  - 3. important period
  - 4. commendable act

**Q.11** Read the given sentence carefully. Change the meaning of the sentence by replacing the underlined word with its ANTONYM from the following options.

I have keen interest in reading the mind of those students who are boisterous at home but on their best behaviour at school.

- Ans**
- 1. clamorous
  - 2. frothing
  - 3. placid
  - 4. raucous

**Q.12** Choose the option that best describes the meaning of the idioms and phrases underlined in the given sentence. You can best identify the fair weather friends at the time of adversity.

- Ans**
- 1. Friends who come in good weather conditions
  - 2. Best friends
  - 3. Friends who bring good rain
  - 4. Friend only at the time of prosperity

Q.13 Select the most appropriate meaning of the underlined idiom in the following sentence.  
I can't begin to talk on this situation right now; I am still wrapping my head around it.

- Ans
- 1. Ignoring something completely
  - 2. Understanding something complicated
  - 3. Comparing two things that can't be compared
  - 4. Revealing a secret nobody knows

Q.14 There is a spelling error in the given sentence. Select the option that contains the INCORRECTLY spelt word.  
The mighty gaint brought a marigold for the princess.

- Ans
- 1. gaint
  - 2. princess
  - 3. marigold
  - 4. mighty

Q.15 Identify the incorrectly spelt word and select its correct spelling.  
The calandar was reformed during the time of Julius Caesar.

- Ans
- 1. reeformed
  - 2. celender
  - 3. riformed
  - 4. calendar

Q.16 Select the most appropriate synonym of the given word.  
Fertile

- Ans
- 1. Productive
  - 2. Destructive
  - 3. Hectic
  - 4. Amusing

Q.17 Select the most appropriate option that can substitute the underlined segment in the given sentence.

Many a women work for the betterment of their family.

- Ans
- 1. Many a woman worked for
  - 2. Many a women working for
  - 3. Many a woman works for
  - 4. Many a women works for

Q.18 Select the most appropriate ANTONYM of the underlined word in the sentence.  
He purchased very cheap dresses.

- Ans
- 1. Expensive
  - 2. Doltish
  - 3. Lively
  - 4. Paltry

Q.19 Select the most appropriate option that can substitute the underlined segment in the given sentence.  
He is almost quiet well.

- Ans
- 1. almost quietly
  - 2. quiet
  - 3. very quite
  - 4. quite

Q.20 Complete the given sentence with an appropriate homophone from the given options.  
It is better to focus on your \_\_\_\_\_ than to wander aimlessly.

- Ans
- 1. carrier
  - 2. courier
  - 3. career
  - 4. carreer

Q.21 Select the most appropriate option to correct the sentence by using meaning of the undelined word.  
In the winter season, the poor woman needed a refuge where she could live freely and independently.

- Ans
- 1. School
  - 2. Shelter
  - 3. Inn
  - 4. Tent

Q.22 The balloon started to deflate after being pricked with a needle. What is the ANTONYM of 'deflate'?

- Ans
- 1. Flatten
  - 2. Compress
  - 3. Inflate
  - 4. Shrink

Q.23 Select the most appropriate synonym of the given word.  
Affirm

- Ans
- 1. Confirm
  - 2. Convey
  - 3. Correlate
  - 4. Deliver

Q.24 Select the most appropriate homophone to fill in the blank.  
The mechanics tried a lot to get that car \_\_\_\_\_ from the accident spot.

- Ans
- 1. told
  - 2. towed
  - 3. toed
  - 4. toad

Q.25 Select the most appropriate option that can substitute the underlined word segment in the following sentence.  
It is a high-pay job.

- Ans
- 1. high-paying
  - 2. low-paid
  - 3. high-paid
  - 4. low-pay

Q.1 What would be the symbol on the opposite side of ' $\leq$ ' if the given sheet is folded to form a cube?

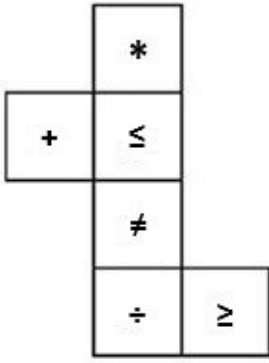

- Ans
- 1. +
  - 2.  $\geq$
  - 3. +
  - 4. \*

Q.2 What should come in place of the question mark (?) in the given series?

15, 30, 90, 360, 1800, ?

- Ans
- 1. 11000
  - 2. 12000
  - 3. 14000
  - 4. 10800

Q.3 Select the option figure in which the given figure is embedded as its part (rotation is NOT allowed).

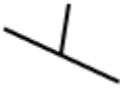

- Ans
- 1.
  - 2.
  - 3.
  - 4.

Q.4 Identify the figure given in the options which when put in place of ? will logically complete the pattern.

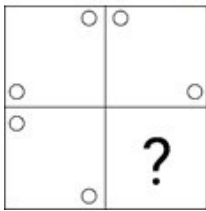

Ans

✓ 1.

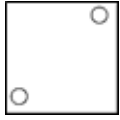

✗ 2.

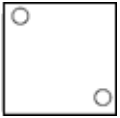

✗ 3.

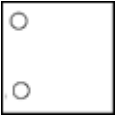

✗ 4.

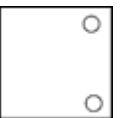

Q.5 If 'W' stands for '÷', 'Y' stands for '×', 'Z' stands for '+' and 'A' stands for '-', what will come in place of the question mark (?) in the following equation?

$$11 W 11 Y 11 Z 11 A 11 = ?$$

Ans

✗ 1. 21

✗ 2. 42

✓ 3. 11

✗ 4. 22

Q.6 In a certain code language, 'cold summers day' is written as 'kl bn ix' and 'day and night' is written as 'kj ed bn'. How is 'day' written in the given language?

Ans

✓ 1. bn

✗ 2. kj

✗ 3. ix

✗ 4. kl

Q.7 How many triangles are there in the following figure?

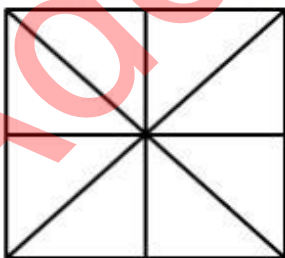

Ans

✗ 1. 17

✓ 2. 16

✗ 3. 15

✗ 4. 14

Q.8 In a certain code language  
A + B means 'A is the son of B'  
A - B means 'A is the brother of B'  
A × B means 'A is the wife of B'  
A ÷ B means 'A is the father of B'  
Based on the above, how is P related to T if 'P × Q - R ÷ S + T'?

- Ans
- 1. Husband's mother
  - 2. Husband's brother's daughter
  - 3. Husband's brother's wife
  - 4. Husband's sister

Q.9 In a certain code language, 'bottle is blue' is coded as 'see mo tu' and 'sky is blue' is coded as 'mo tu lo'. What is the code for 'bottle' in that language?

- Ans
- 1. see
  - 2. tu
  - 3. mo
  - 4. lo

Q.10 What should come in place of ? in the given series based on the English alphabetical order?

GOW NIB UCG BWL ?

- Ans
- 1. ZQH
  - 2. XOF
  - 3. VLB
  - 4. IQQ

Q.11 If 'A' stands for '+', 'B' stands for '×', 'C' stands for '+' and 'D' stands for '-', then the resultant of which of the following will be 59?

- Ans
- 1. 22 B 6 D 190 C 2 A 22
  - 2. 22 A 6 D 190 B 2 C 22
  - 3. 22 B 6 C 190 A 2 D 22
  - 4. 22 B 6 D 190 A 2 C 22

Q.12 Select the word-pair that best represents a similar relationship to the one expressed in the pair of words given below. (The words must be considered as meaningful English words and must not be related to each other based on the number of letters/number of consonants/vowels in the word.)

Antibiotic : Infection

- Ans
- 1. Purgative : Eating
  - 2. Antidote : Poisoning
  - 3. Antibody : Braise
  - 4. Anticlimax : Episode

Q.13 Select the option in which the given figure X is embedded (i.e. contains figure X in the same form).

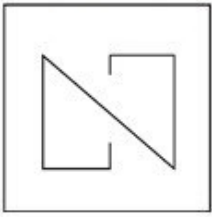

(X)

Ans

✓ 1.

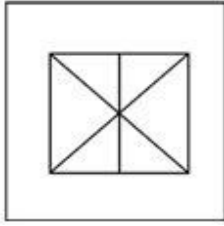

✗ 2.

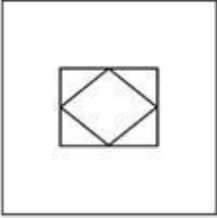

✗ 3.

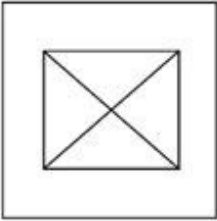

✗ 4.

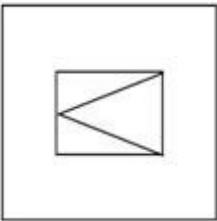

Q.14 What would be the symbol on the opposite side of '+' if the given sheet is folded to form a cube?

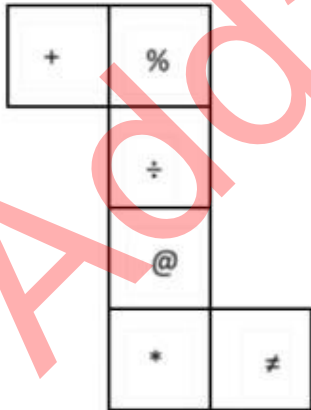

Ans ✗ 1. %

✗ 2. +

✓ 3. \*

✗ 4. ≠



**Q.15** Select the set in which the numbers are related in the same way as are the numbers of the following sets.  
(NOTE: Operations should be performed on the whole numbers, without breaking down the numbers into its constituent digits. E.g. 13 – Operations on 13 such as adding/subtracting/multiplying etc. to 13 can be performed. Breaking down 13 into 1 and 3 and then performing mathematical operations on 1 and 3 is not allowed.)  
(3, 34, 5)  
(10, 136, 6)

- Ans**
- 1. (7, 113, 8)
  - 2. (9, 115, 6)
  - 3. (5, 60, 6)
  - 4. (11, 125, 4)

**Q.16** If 'A' stands for '+', 'B' stands for '×', 'C' stands for '÷' and 'D' stands for '−', what will come in place of the question mark (?) in the following equation?

$$96 \text{ B } 3 \text{ D } 285 \text{ A } 5 \text{ C } 11 = ?$$

- Ans**
- 1. 252
  - 2. 262
  - 3. 242
  - 4. 272

**Q.17** Read the given statements and conclusions carefully. Assuming that the information given in the statements is true, even if it appears to be at variance with commonly known facts, decide which of the given conclusions logically follow(s) from the statements.

Statements:

No pillow is a cushion.

All cushions are sheets.

No sheet is a blanket.

Conclusions:

(I) No cushion is a blanket.

(II) Some pillows are sheets.

- Ans**
- 1. Only conclusion I follows
  - 2. None of the conclusions follow
  - 3. Both conclusions I and II follow
  - 4. Only conclusion II follows

**Q.18** Which of the following numbers will replace the question mark (?) in the given series?

291 256 310 275 329 294 ?

- Ans**
- 1. 356
  - 2. 375
  - 3. 331
  - 4. 348

**Q.19** Three of the following four letter-clusters are alike in a certain way and thus form a group. Which is the one that does NOT belong to that group?

(Note: The odd one out is not based on the number of consonants/vowels or their position in the letter cluster.)

1) ADBC

2) JMKL

3) FJHI

4) VYWX

- Ans**
- 1. FJHI
  - 2. VYWX
  - 3. JMKL
  - 4. ADBC

Q.20 30 is related to 216 by certain logic. Following the same logic, 40 is related to 226. To which of the following is 50 related, following the same logic?

(NOTE: Operations should be performed on the whole numbers, without breaking down the numbers into its constituent digits. E.g. 13 – Operations on 13 such as adding/subtracting/multiplying etc. to 13 can be performed. Breaking down 13 into 1 and 3 and then performing mathematical operations on 1 and 3 is not allowed.)

Ans  1. 236

2. 238

3. 250

4. 248

Q.21 A paper is folded and cut as shown below. How will it appear when unfolded?

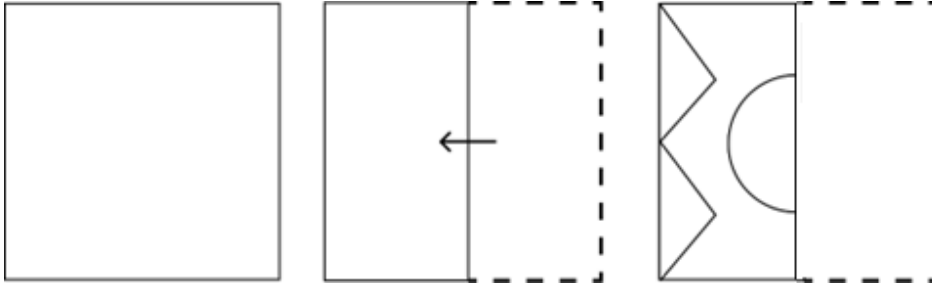

Ans

1.

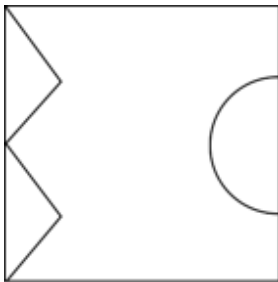

2.

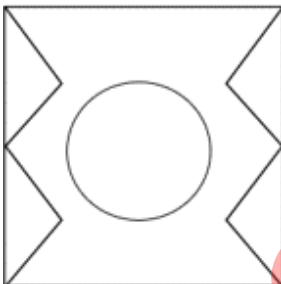

3.

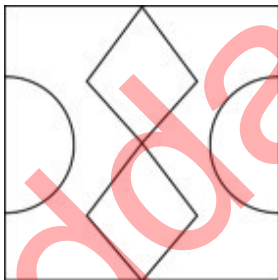

4.

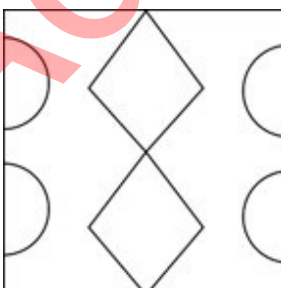

**Q.22** The position of how many letters will remain unchanged if each of the letters in the word FLAMINGOES is arranged from left to right in alphabetical order?

- Ans**
- 1. None
  - 2. Three
  - 3. One
  - 4. Two

**Q.23** Select the word-pair that best represents a similar relationship to the one expressed in the pair of words given below.

(The words must be considered as meaningful English words and must not be related to each other based on the number of letters/number of consonants/vowels in the word)

Carpenter : Furniture

- Ans**
- 1. Cook : Soup
  - 2. Dam : Engineer
  - 3. Book : Author
  - 4. Magazine : Editor

**Q.24** Select the correct combination of letters that when sequentially placed in the blanks of the given series will make the series logically complete.

\_WSVR\_QTPS\_RNQM\_ LOK\_

- Ans**
- 1. XUQPM
  - 2. XVQLM
  - 3. TVOLN
  - 4. TUOPN

**Q.25** If 16 September 2010 is Thursday, then what will be the day of the week on 17 August 2017?

- Ans**
- 1. Wednesday
  - 2. Monday
  - 3. Sunday
  - 4. Thursday

Section : Quantitative Aptitude

Q.1

Read the given information and answer the question that follows.

The following table gives the percentage of marks obtained by seven students in six different subjects in an examination.

The number in the brackets gives the maximum marks in each subject.

Student	Subject (Max. Marks)					
	Maths	Chemistry	Physics	Geography	History	Computer Science
	(150)	(130)	(120)	(100)	(60)	(40)
Ayush	90	50	90	60	70	80
Aman	100	80	80	40	80	70
Sajal	90	60	70	70	90	70
Rohit	80	65	80	80	60	60
Muskan	80	65	85	95	50	90
Tanvi	70	75	65	85	40	60
Tarun	65	35	50	77	80	80

How many students secured a raw score of at least 30 in Computer Science?

Ans



1. 3



2. 5



3. 4



4. 2

Q.2

The perimeter of a semi-circle is 56.54 cm. What is its diameter (in cm)?

(Use  $\pi = 3.14$ )

Ans



1. 11



2. 22



3. 10



4. 20

Q.3

Express the following as decimals, respectively.

20%, 0.5%, 0.03%

Ans



1. 0.02, 0.005, 0.0003



2. 0.02, 0.005, 0.003



3. 0.2, 0.005, 0.0003



4. 0.2, 0.0005, 0.0003

Q.4

The diameter of a cylinder is 14 cm and its height is 9 cm. Find the total surface area of the cylinder.

Ans

1.  $708 \text{ cm}^2$ 2.  $714 \text{ cm}^2$ 3.  $704 \text{ cm}^2$ 4.  $700 \text{ cm}^2$

Q.5 If  $\theta$  is an acute angle and  $\cot\theta + \tan\theta = 2$ , then find the value of  $\tan^{12}\theta + \cot^{12}\theta + 2\tan^5\theta\cot^7\theta$ .

- Ans
- 1. 4
  - 2. 3
  - 3. 1
  - 4. 2

Q.6 A car covers a certain distance in 85 minutes, if it runs at a speed of 36 km/hr. The speed at which the car must run to reduce the time of journey to 51 minutes will be:

- Ans
- 1. 70 km/hr
  - 2. 80 km/hr
  - 3. 60 km/hr
  - 4. 50 km/hr

Q.7 The profit (in Rupees) earned by four companies in the different quarters of the year 2020 are shown in the chart. The data shown is in crores.



How much is the average profit earned by ITC in the year 2020?

- Ans
- 1. ₹ 1400 crore
  - 2. ₹ 1325 crore
  - 3. ₹ 1350 crore
  - 4. ₹ 1225 crore

Q.8 Two circles with centres M and N have radii 5 cm and 8 cm, respectively. The circles touch each other externally at point T. A line PR is drawn such that the points M, T and N lie on PR, P being closer to M. From P, a tangent PQ = 12 cm is drawn to the circle with centre M touching at Q, and from R, another tangent RS = 15 cm is drawn to the circle with centre N touching at S. What is the length (in cm) of PR?

- Ans
- 1. 37
  - 2. 43
  - 3. 53
  - 4. 26

Q.9 Find the remainder, when we divide  $2x^3 - 3x^2 + 6x - 4$  by  $2x - 3$ .

- Ans
- 1. 5
  - 2. 6
  - 3. -5
  - 4. -6

Q.10 Find the third proportion to 36 and 48.

- Ans
- 1. 36
  - 2. 54
  - 3. 64
  - 4. 48

Q.11 A retailer purchased a batch of goods for ₹5,000. Due to a manufacturing defect, 5% of the goods were damaged. If the retailer wants to make a profit of 20% on the remaining goods, at what price should the undamaged goods be sold?

- Ans
- 1. ₹5,700
  - 2. ₹5,800
  - 3. ₹6,000
  - 4. ₹5,900

Q.12 Find the capacity of an overhead cylindrical water tank, in litres, whose radius is 2.1 m and height is 6.3 m.

- Ans
- 1. 61802
  - 2. 87318
  - 3. 611726
  - 4. 65622

Q.13 The total surface area of a solid hemisphere of diameter 28 cm is:

- Ans
- 1.  $1784 \text{ cm}^2$
  - 2.  $1488 \text{ cm}^2$
  - 3.  $1648 \text{ cm}^2$
  - 4.  $1848 \text{ cm}^2$

Q.14 Last year, Geeta's monthly salary was ₹12,000 and Seeta's monthly salary was ₹10,000. This year, Geeta's monthly salary is ₹14,400, while Seeta's monthly salary is ₹12,500. If the percentage increase in Seeta's monthly salary this year over her monthly salary last year is denoted by  $x\%$ , and the percentage increase in Geeta's monthly salary this year over her monthly salary last year is denoted by  $y\%$ , then what is the value of  $(\frac{x-y}{y} \times 100)\%$ ?

- Ans
- 1. 24
  - 2. 20
  - 3. 22
  - 4. 25

Q.15  $\triangle DEF$  and  $\triangle GHI$  are two similar triangles. If  $DE = 64 \text{ cm}$ ,  $GH = 24 \text{ cm}$  and the perimeter of  $\triangle GHI$  is  $72 \text{ cm}$ , then what is the sum of the lengths (in cm) of the sides  $EF$  and  $FD$  of the  $\triangle DEF$ ?

- Ans
- 1. 192
  - 2. 96
  - 3. 128
  - 4. 82

Q.16 If the average of a number and its reciprocal is 2, then the average of its cube and its reciprocal is equal to:

- Ans
- 1. 28
  - 2. 26
  - 3. 48
  - 4. 36

Q.17 Simplify:

$$3\frac{4}{7} - \left[ 16\frac{1}{2} \div \left\{ 6^2 - \left( 7 - 2\frac{1}{2} \right) \right\} \right]$$

- Ans
- 1.  $\frac{64}{21}$
  - 2.  $\frac{25}{21}$
  - 3.  $\frac{64}{11}$
  - 4.  $\frac{25}{11}$

Q.18 The price of pulses has increased by 45%. By what percentage (rounded off to the nearest integer) the increased price of the pulses should be reduced so that the price of the pulses remains unaltered?

- Ans
- 1. 45
  - 2. 31
  - 3. 41
  - 4. 35

Q.19 To finish a work in 12 days, 8 workers are engaged. After 2 days, due to some urgency, the work is to be finished in next 2 days. How many more workers are to be engaged now to finish it on time?

- Ans
- 1. 30
  - 2. 32
  - 3. 36
  - 4. 40

Q.20 Study the given graph and answer the question that follows.  
Ratio of imports to exports from two companies over the years.

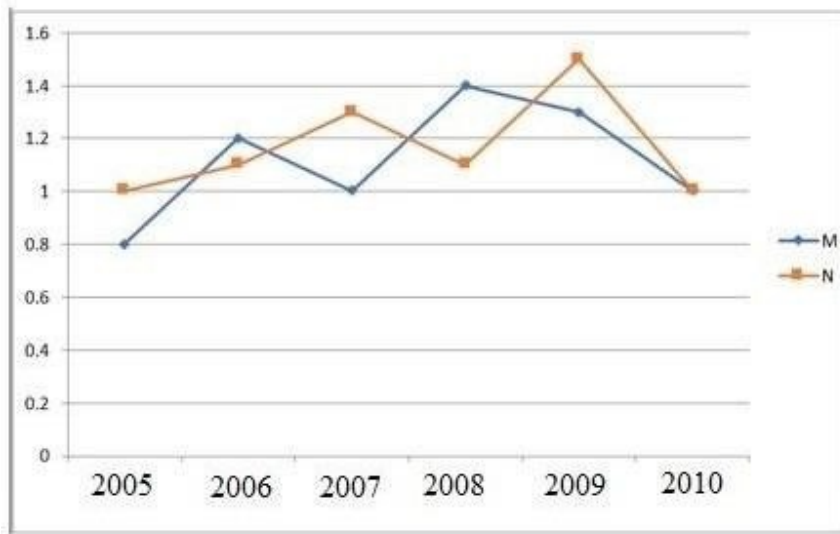

In how many of the given years were the imports more than the exports of Company N ?

Ans

- 1. 2
- 2. 1
- 3. 3
- 4. 4

Q.21 The marked price of an article is 25% more than its cost price. If a scheme discount of 40% is given, then the loss percentage is:

Ans

- 1. 20%
- 2. 25%
- 3. 30%
- 4. 15%

Q.22 A circle of diameter 26 cm has two equal chords of length 10 cm each, separated by a distance h cm. What is the value of h?

Ans

- 1. 18
- 2. 12
- 3. 24
- 4. 16

Q.23 The age of a father will be double the age of his son ten years later. 10 years ago, the father's age was six times the age of the son. How many years from now, the ratio of their ages will be 3 : 2?

Ans

- 1. 35
- 2. 30
- 3. 20
- 4. 25



Q.24 The given line graph shows the number of scooters manufactured (in thousands) by companies X and Z, over the years.

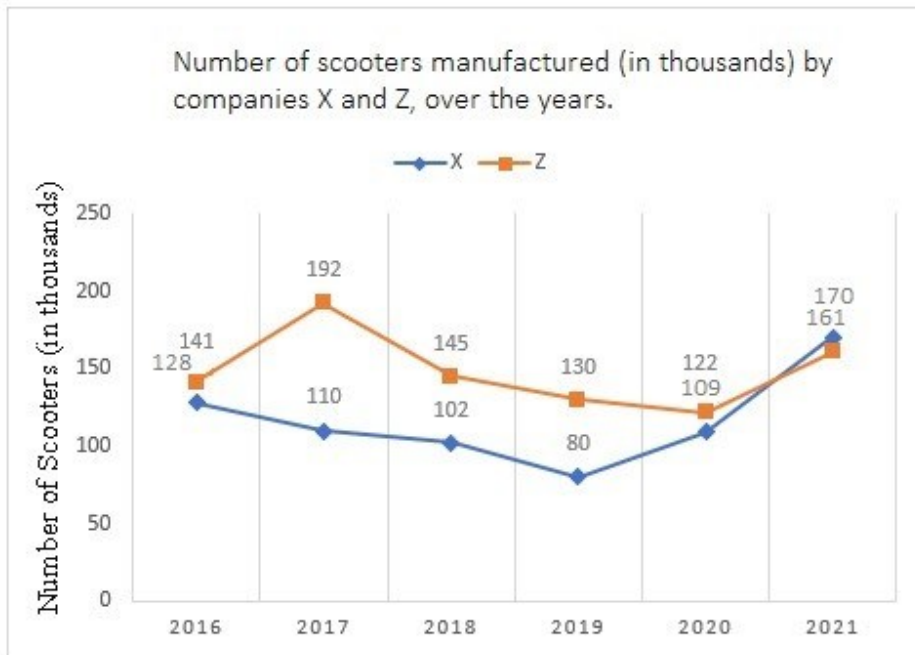

In which of the following years was the difference between the production by companies X and Z the maximum among the given years?

- Ans
- 1. 2018
  - 2. 2017
  - 3. 2020
  - 4. 2019

Q.25 Rahna decided to buy a scooty that costs ₹40,000. The shopkeeper agreed to sell the scooty under the condition of ₹25,000 cash down payment of ₹4,000 each month for four months. Find the rate of interest at which the shopkeeper sold the scooty under the instalment scheme.

- Ans
- 1. 33%
  - 2.  $10\frac{1}{3}\%$
  - 3.  $18\frac{1}{2}\%$
  - 4.  $16\frac{1}{2}\%$

Section : General Awareness

1. The 5th edition of the Khelo India Youth Games 2023 was hosted in January-February, 2023 by \_\_\_\_\_

- Ans
- 1. Uttar Pradesh
  - 2. Delhi
  - 3. Rajasthan
  - 4. Madhya Pradesh

2. In a spread sheet, page orientation is changed through \_\_\_\_\_.

- Ans
- 1. page setup dialog box
  - 2. format dialogue box
  - 3. print dialog box
  - 4. paper dialog box

3. Which of the following is a part of apical meristem found in roots.

Ans 1. Protoderm

- 2. Leaf primordium
- 3. Differentiating vascular tissue
- 4. Axillary bud

Q.4 The institute established by Kaka Hathrasi in 1932 is:

- Ans
- 1. Music Art Centre
  - 2. Swar Sangam Kendra
  - 3. Sangeet Karyalaya
  - 4. Music Art Kendra

Q.5 In an electrical circuit, the ammeter reading decreases to \_\_\_\_\_ when the length of the wire is doubled.

- Ans
- 1. one-sixth
  - 2. one-half
  - 3. one-fourth
  - 4. one-third

Q.6 Which of the following steps is used to format a cell in an MS Excel Spreadsheet?

- Ans
- 1. Menu → Select cell → Format
  - 2. Select cell → Right click → Format cell
  - 3. Select cell → View → Format cell
  - 4. View → Select cell → Format

Q.7 Match the following ports with their related states correctly.

Ports	States
1. Mormugao port	a. West Bengal
2. Paradip Port	b. Odisha
3. Haldia Port	c. Tamil Nadu
4. Tuticorin port	d. Goa

- Ans
- 1. 1-b, 2-d, 3-c, 4-a
  - 2. 1-a, 2-b, 3-d, 4-c
  - 3. 1-d, 2-b, 3-a, 4-c
  - 4. 1-b, 2-d, 3-a, 4-c

Q.8 Which is the first state to receive rain from the Monsoon in India?

- Ans
- 1. Kerala
  - 2. Goa
  - 3. Andhra Pradesh
  - 4. Karnataka

Q.9 In which of the following cities was the Asian Wrestling Championship 2023 held?

- Ans
- 1. Mumbai
  - 2. Astana
  - 3. Tokyo
  - 4. Karachi

Q.10 Federalism in the Indian constitutional context means:

- Ans
- 1. the existence only one level of government in the country
  - 2. the existence of one nation one government in the country
  - 3. the existence of states in the country
  - 4. the existence of more than one level of government in the country

Q.11 Which of the following schemes is related to minimising the use of chemical fertilisers, given in the Union Budget 2023-24?

- Ans
- 1. PM Pranam
  - 2. PM DevINE
  - 3. SEEDScheme
  - 4. PM Shri

Q.12 Jagori and Cholom are two divisions in the Indian classical dance form of \_\_\_\_\_.

- Ans
- 1. Kathak
  - 2. Manipuri
  - 3. Kathakali
  - 4. Bharatanatyam

Q.13 Which of the following is NOT any position in the Basketball sport?

- Ans
- 1. Point guard
  - 2. Shooting guard
  - 3. Small forward
  - 4. All rounder

Q.14 As of August, 2023, which of the following states has India's first fully functionally literate district?

- Ans
- 1. Madhya Pradesh
  - 2. Maharashtra
  - 3. Kerala
  - 4. Goa

Q.15 The President of India appointed \_\_\_\_\_ as the Governor of Karnataka in July 2021.

- Ans
- 1. Hari Babu Kambhampati
  - 2. Thaawar Chand Gehlot
  - 3. Rajendra Vishwanath Arlekar
  - 4. Mangubhai Chhaganbhai Patel

Q.16 In Hindustani classical music, according to Vishnu Narayana Bhatkhande, how many thaats are the origins of ragas?

- Ans
- 1. 52
  - 2. 72
  - 3. 10
  - 4. 20

Q.17 The Prarthana Samaj was established in \_\_\_\_\_ by Dr. Atma Ram Pandurang.

- Ans
- 1. Bombay
  - 2. Calcutta
  - 3. Adyar
  - 4. Delhi

Q.18 Where is the oldest centre of lace work located in Gujarat?

- Ans
- 1. Ahmedabad
  - 2. Rajkot
  - 3. Jamnagar
  - 4. Kutch

Q.19 The Chau dancers of \_\_\_\_\_ organise a festival named Chau-Jhumur Utsav, where an open stage is designed for the performance by Chau groups.

- Ans
- 1. West Bengal
  - 2. Chhattisgarh
  - 3. Jharkhand
  - 4. Madhya Pradesh

Q.20 In which year was the 'Aatmanirbhar Bharat Rojgar Yojana' launched by the Government of India?

- Ans
- 1. 2020
  - 2. 2022
  - 3. 2015
  - 4. 2010

Q.21 Which of the following years were considered plan holidays in Independent India?

- Ans
- 1. 1964-1967
  - 2. 1990-1992
  - 3. 1969-1972
  - 4. 1966-1969

Q.22 \_\_\_\_\_ is defined as excess of total expenditure over total receipts excluding borrowings during a fiscal year.

- Ans
- 1. Fiscal deficit
  - 2. Income deficit
  - 3. Structural deficit
  - 4. Gross Primary deficit

Q.23 Part IV A of the Indian Constitution is related to \_\_\_\_\_.

- Ans
- 1. Directive Principles of State Policy
  - 2. Fundamental Duties
  - 3. Fundamental Rights
  - 4. Citizenship

Q.24 Which of the following statements most accurately describes the planet Saturn?

- Ans
- 1. Its surface is reddish in colour.
  - 2. It is a gas giant made up mostly of hydrogen and helium and the density is less than that of water.
  - 3. It was the seventh planet discovered in the Solar System.
  - 4. Its cloud-like outer regions consist of methane in the gaseous form and ammonia in crystalline form.

Q.25 Who defeated Mohammad Ghori in the First Battle of Tarain fought in the year 1191?

- Ans
- 1. Prithviraj Chauhan
  - 2. Vasudev
  - 3. Yashovarman
  - 4. Vidyadhar

## Combined Higher Secondary Level Examination 2024 Tier I

Exam Date	04/07/2024
Exam Time	5:15 PM - 6:15 PM
Subject	CHSL Exam 2024 Tier I

### Section : English Language

1. The following sentence has been divided into four segments. Identify the segment that contains a grammatical error. She was singing / beautifully in / the concert hall / last night.

- Ans
- 1. the concert hall
  - 2. last night.
  - 3. She was singing
  - 4. beautifully in

2. Identify the error in the following sentence and select the option with the correct use of the phrasal verb. The police inspector was trying to give out the contradicting stories in the scene of the accident.

- Ans
- 1. The police inspector was trying to sign up the contradicting stories in the scene of the accident.
  - 2. The police inspector was trying to rush out the contradicting stories in the scene of the accident.
  - 3. The police inspector was trying to sort out the contradicting stories in the scene of the accident.
  - 4. The police inspector was trying to lighten up the contradicting stories in the scene of the accident.

3. Parts of the following sentence have been given as options. Select the option that contains an error. I will be study around 7 o'clock.

- Ans
- 1. around 7 o'clock
  - 2. be study
  - 3. will
  - 4. I

Q.4 The given sentence is divided into four segments. Select the option that has the segment with the grammatical error. My daughter participate / in the dance competition / that is organised every year / by the Lion's Club.

- Ans
- 1. in the dance competition
  - 2. that is organised every year
  - 3. My daughter participate
  - 4. by the Lion's Club.

**Comprehension:**

In the following passage, some words have been deleted. Read the passage carefully and select the most appropriate option to fill in each blank.

Nutrition experts have researched the bad effects of junk food and have come to the (1) that junk food manufacturing companies are fooling the people by (2) deceptive advertisements that show junk food as healthy. We must substitute junk food with (3) food like fruits and vegetables. So the next time you think of (4) that burger, hotdog, pizza, samosa, kachori or even ice cream in a restaurant, eating joint or a party, stop your instincts and look for some healthier food (5) instead.

**SubQuestion No : 5****Q.5 Select the most appropriate option to fill in blank number 1.**

- Ans
- 1. conclusion
  - 2. derivation
  - 3. solution
  - 4. assumption

**Comprehension:**

In the following passage, some words have been deleted. Read the passage carefully and select the most appropriate option to fill in each blank.

Nutrition experts have researched the bad effects of junk food and have come to the (1) that junk food manufacturing companies are fooling the people by (2) deceptive advertisements that show junk food as healthy. We must substitute junk food with (3) food like fruits and vegetables. So the next time you think of (4) that burger, hotdog, pizza, samosa, kachori or even ice cream in a restaurant, eating joint or a party, stop your instincts and look for some healthier food (5) instead.

**SubQuestion No : 6****Q.6 Select the most appropriate option to fill in blank number 2.**

- Ans
- 1. observing
  - 2. showing
  - 3. blowing
  - 4. assuming

**Comprehension:**

In the following passage, some words have been deleted. Read the passage carefully and select the most appropriate option to fill in each blank.

Nutrition experts have researched the bad effects of junk food and have come to the (1) that junk food manufacturing companies are fooling the people by (2) deceptive advertisements that show junk food as healthy. We must substitute junk food with (3) food like fruits and vegetables. So the next time you think of (4) that burger, hotdog, pizza, samosa, kachori or even ice cream in a restaurant, eating joint or a party, stop your instincts and look for some healthier food (5) instead.

**SubQuestion No : 7****Q.7 Select the most appropriate option to fill in blank number 3.**

- Ans
- 1. powerful
  - 2. expensive
  - 3. healthier
  - 4. cleaner

**Comprehension:**

In the following passage, some words have been deleted. Read the passage carefully and select the most appropriate option to fill in each blank.

Nutrition experts have researched the bad effects of junk food and have come to the (1) that junk food manufacturing companies are fooling the people by (2) deceptive advertisements that show junk food as healthy. We must substitute junk food with (3) food like fruits and vegetables. So the next time you think of (4) that burger, hotdog, pizza, samosa, kachori or even ice cream in a restaurant, eating joint or a party, stop your instincts and look for some healthier food (5) instead.

**SubQuestion No : 8****Q.8 Select the most appropriate option to fill in blank number 4.**

- Ans
- 1. skipping
  - 2. grabbing
  - 3. building
  - 4. turning

**Comprehension:**

In the following passage, some words have been deleted. Read the passage carefully and select the most appropriate option to fill in each blank.

Nutrition experts have researched the bad effects of junk food and have come to the (1)\_\_\_\_\_that junk food manufacturing companies are fooling the people by (2)\_\_\_\_\_deceptive advertisements that show junk food as healthy. We must substitute junk food with (3)\_\_\_\_\_food like fruits and vegetables. So the next time you think of (4)\_\_\_\_\_that burger, hotdog, pizza, samosa, kachori or even ice cream in a restaurant, eating joint or a party, stop your instincts and look for some healthier food (5)\_\_\_\_\_instead.

**SubQuestion No : 9**

**Q.9** Select the most appropriate option to fill in blank number 5.

- Ans
- 1. comparisons
  - 2. chances
  - 3. additions
  - 4. options

**Q.10** Select the most appropriate synonym of the given word.

Desire

- Ans
- 1. Loathing
  - 2. Aversion
  - 3. Disgust
  - 4. Longing

**Q.11** Select the most appropriate option that can substitute the underlined segment in the given sentence.  
He takes his always dog for a walk in the park.

- Ans
- 1. takes his dog for always a walk
  - 2. takes his dog for an always walk
  - 3. always takes his dog for a walk
  - 4. his dog for a walk always takes

**Q.12** Select the most appropriate option that can substitute the underlined segment in the given sentence. If there is no need to substitute it, select 'No substitution required'.  
She was thinking at the fun they had.

- Ans
- 1. beside
  - 2. by
  - 3. No substitution required
  - 4. about

**Q.13** Select the most appropriate ANTONYM of the given word.  
Vehement

- Ans
- 1. Reliable
  - 2. Smashed
  - 3. Passionate
  - 4. Mild

**Q.14** Select the most appropriate option of the given word to fill in the blank.  
The new construction sites have \_\_\_\_\_attack by the environmentalists.

- Ans
- 1. come off
  - 2. come upon
  - 3. come under
  - 4. come out

Q.15 Select the most appropriate ANTONYM of the underlined word.

The growth of the cell wall is very rarely uniform.

- Ans
- 1. Paired
  - 2. Balanced
  - 3. Fixed
  - 4. Variegated

Q.16 Identify the most appropriate ANTONYM of the underlined word in the following sentence.

There is no transparency in the procedure followed by the company.

- Ans
- 1. Coherence
  - 2. Reliability
  - 3. Clarity
  - 4. Opacity

Q.17 Select the INCORRECTLY spelt word in the given sentence.

Shreya prefers wearing green coloured saree on marriage funcktions.

- Ans
- 1. Prefers
  - 2. Wearing
  - 3. Funcktions
  - 4. Marriage

Q.18 Select the most appropriate ANTONYM of the given word.

Noble

- Ans
- 1. Grand
  - 2. Indescribable
  - 3. Common
  - 4. Magical

Q.19 Select the most appropriate ANTONYM of the underlined word in the given sentence.

The performance of the team in the lost match was dismal.

- Ans
- 1. Luminous
  - 2. Sadden
  - 3. Cheap
  - 4. Dainty

Q.20 Select the most appropriate meaning of the given idiom.

A bolt from the blue

- Ans
- 1. A sudden and unexpected event
  - 2. Thunder and rain in a storm
  - 3. Raining heavily
  - 4. A spontaneous but expected event

Q.21 Select the most appropriate ANTONYM of the given word.

Benevolent

- Ans
- 1. Cruel
  - 2. Happy
  - 3. Patient
  - 4. Harmless



Q.22 Select the most appropriate option that can substitute the underlined word in the given sentence.  
A newer, more effective computer system was installed in place of the obsolete one.

- Ans
- 1. outdated
  - 2. current
  - 3. modern
  - 4. advanced

Q.23 Select the most appropriate option that can substitute the underlined segment in the given sentence. If there is no need to substitute it, select 'No substitution required'.  
I had to write a letter of mistake to my father for the blunder I made.

- Ans
- 1. apology
  - 2. No substitution required
  - 3. gratitude
  - 4. circumstance

Q.24 Select the INCORRECTLY spelt word.

- Ans
- 1. Physiologist
  - 2. Contagious
  - 3. Gracious
  - 4. Couragious

Q.25 Select the most appropriate meaning of the given idiom.  
Walk a tightrope

- Ans
- 1. To walk on a narrow road
  - 2. To act carefully in a difficult situation
  - 3. To be tensed about something
  - 4. To try and balance yourself

Section : General Intelligence

Q.1 Select the set in which the numbers are related in the same way as are the numbers of the following sets.  
(NOTE: Operations should be performed on the whole numbers, without breaking down the numbers into its constituent digits. E.g. 13 – Operations on 13 such as adding / subtracting/multiplying etc. to 13 can be performed. Breaking down 13 into 1 and 3 and then performing mathematical operations on 1 and 3 is not allowed)  
(35, 5, 7)  
(108, 12, 9)

- Ans
- 1. (118, 15, 9)
  - 2. (91, 13, 7)
  - 3. (254, 17, 7)
  - 4. (114, 14, 8)

Q.2 What would be the symbol on the opposite side of '\*' if the given sheet is folded to form a cube?

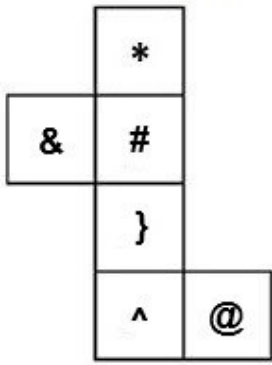

- Ans
- 1. &
  - 2. }
  - 3. @
  - 4. ^

3. The position of how many letters will remain unchanged if each of the letters in the word 'COUNTED' is arranged in English alphabetical order?

- Ans
- 1. None
  - 2. Two
  - 3. More than three
  - 4. Three

Q.4 In a certain code language, 'now or never' is coded as 'ak bj ut' and 'never be late' is coded as 'bj tl cv'. How is 'never' coded in that language?

- Ans
- 1. cv
  - 2. bj
  - 3. ak
  - 4. tl

Q.5 Select the correct mirror image of the given figure when the mirror is placed at MN, as shown.

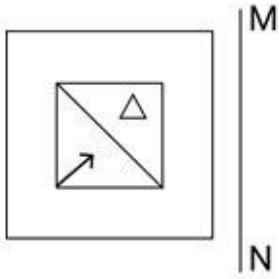

Ans

X 1.

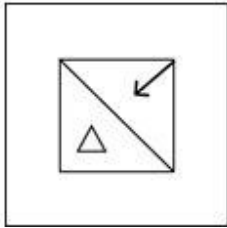

X 2.

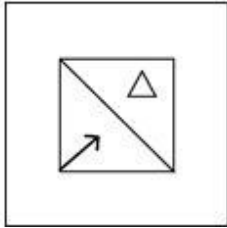

✓ 3.

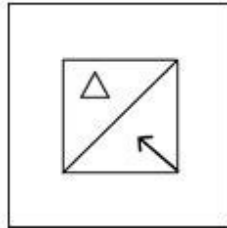

X 4.

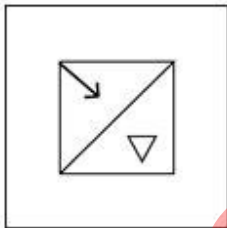

Q.6 What would be the Roman numeral on the opposite side of 'VI' if the given sheet is folded to form a cube?

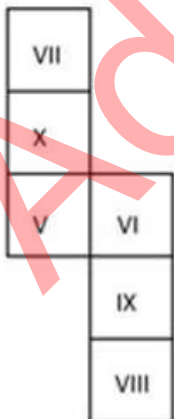

Ans X 1. VII

✓ 2. VIII

X 3. V

X 4. X

Q.7 What should come in place of ? in the given series?

119 128 137 146 155 ?

Ans  1. 164

2. 163

3. 161

4. 162

Q.8 If 'A' stands for '+', 'B' stands for 'x', 'C' stands for '+' and 'D' stands for '-', then the resultant of which of the following will be 652?

Ans  1. 109 B 6 A 16 D 2 C 6

2. 109 B 6 D 16 A 2 C 6

3. 109 C 6 D 16 A 2 B 6

4. 109 A 6 D 16 B 2 C 6

Q.9 Which of the following letter-clusters will replace the question mark (?) in the given series to make it logically complete?  
LPT, ?, BBF, JUL, RNR

Ans  1. COD

2. TIZ

3. FIZ

4. UTL

Adda247 Marathi

Q.10 A square sheet of paper is folded along the dotted line successively along the directions shown and is then punched in the last. How would the paper look when unfolded?

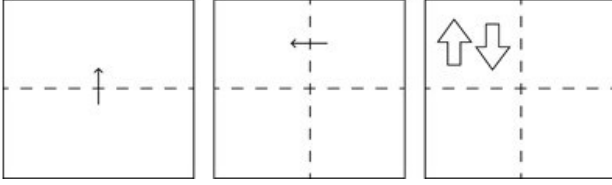

Ans

✗ 1.

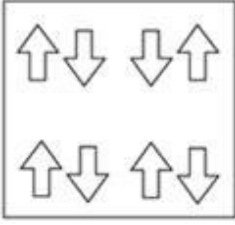

✗ 2.

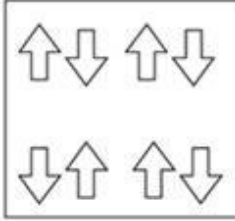

✗ 3.

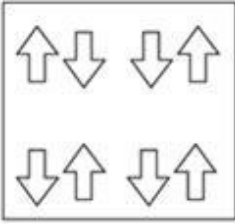

✓ 4.

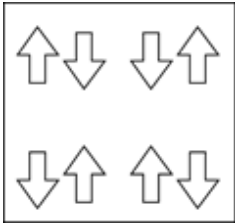

Q.11 The position of how many letters will remain unchanged if each of the letters in the word 'POWDERS' is arranged in English alphabetical order?

Ans ✗ 1. More than three

✗ 2. Three

✓ 3. None

✗ 4. One

Q.12 उस शब्द-युग्म का चयन कीजिए जो नीचे दिए गए शब्दों के युग्म में व्यक्त किए गए समान संबंध का सबसे अच्छा निरूपण करता है। (शब्दों को अर्थपूर्ण हिंदी शब्दों के रूप में माना जाना चाहिए और उन्हें शब्द में अक्षरों की संख्या/व्यंजन/स्वरों की संख्या के आधार पर एक दूसरे से संबंधित नहीं किया जाना चाहिए।)

कुत्ते - भौंकना

Ans ✗ 1. सांप - दहाड़ना

✗ 2. गायें - किकियाना

✓ 3. गधे - रेंकना

✗ 4. बिल्लियां - फुफकारना

Q.13 Select the combination of letters that when sequentially placed in the blanks of the given series will complete the series.

PQRSO TT UV MW V

- Ans
- 1. TSUX
  - 2. NTUY
  - 3. SNUX
  - 4. XTUS

Q.14 Identify the figure given in the options which when put in place of the question mark (?) will logically complete the series?

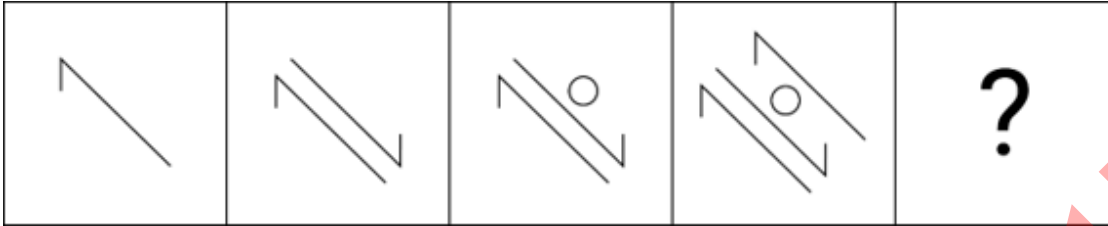

Ans

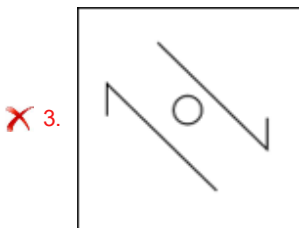
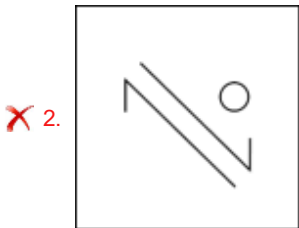
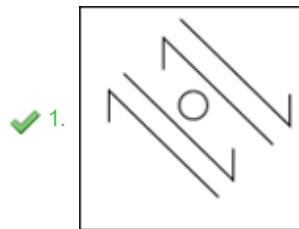

Q.15 Choose the alternative which closely resembles the mirror image of the given combination.

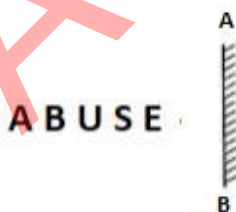

- Ans
- 1. E2UBA
  - 2. ABUSE
  - 3. E2UBA
  - 4. E2UBA

Q.16 Select the word-pair that best represents a similar relationship to the one expressed in the pair of words given below.

(The words must be considered as meaningful English words and must not be related to each other based on the number of letters/number of consonants/vowels in the word)

Pleasure : Pain

- Ans
- 1. Fast: Quick
  - 2. Gentle : Brutal
  - 3. Smart : Intelligent
  - 4. Angry : Furious

Q.17 Four letter-clusters have been given, out of which three are alike in some manner and one is different. Select the letter-cluster that is different.

(Note: The odd one out is not based on the number of consonants/vowels or their position in the letter cluster.)

- Ans
- 1. CWSR
  - 2. MGCA
  - 3. KEAY
  - 4. SMIG

Q.18 In a certain code language,  
'P + Q' means 'P is the wife of Q'.  
'P - Q' means 'P is the brother of Q'.  
'P / Q' means 'P is the son of Q'.  
'P × Q' means 'P is the father of Q'.  
If 'V / K × T + M × O', then how is K related to O?

- Ans
- 1. Mother's father
  - 2. Mother
  - 3. Father's mother
  - 4. Father

Q.19 If 'T' stands for '+', 'P' stands for '÷', 'Q' stands for '×' and 'R' stands for '-', what will come in place of the question mark (?) in the following equation?

$$24 T 36 P 48 Q 32 R 40 T 53 = ?$$

- Ans
- 1. 61
  - 2. 73
  - 3. 31
  - 4. 48

Q.20 If 'A' stands for '+', 'B' stands for '×', 'C' stands for '-' and 'D' stands for '÷', what will come in place of the question mark (?) in the following equation?

$$26 B 3 C 5 D 120 A 4 = ?$$

- Ans
- 1. 53
  - 2. 57
  - 3. 51
  - 4. 55

Q.21 How many rectangles are there in the given figure?

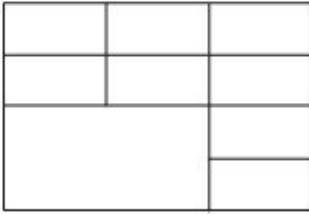

- Ans
- 1. 31
  - 2. 33
  - 3. 34
  - 4. 32

Q.22 What should come in place of the question mark (?) in the given series?  
512, 1000, 1728, 2744, 4096, 5832, ?

- Ans
- 1. 4000
  - 2. 8000
  - 3. 9261
  - 4. 6000

Q.23 In a certain language, 'How are you' is written as 'Co De Ki' and 'You look happy' is written as 'Th De Mo'. How is 'you' written in the given language?

- Ans
- 1. Ki
  - 2. Co
  - 3. De
  - 4. Mo

Q.24 17 is related to 136 following a certain logic. Following the same logic, 23 is related to 184. To which of the following is 29 related following the same logic?  
(NOTE: Operations should be performed on the whole numbers, without breaking down the numbers into its constituent digits. E.g. 13 – Operations on 13 such as adding/subtracting/multiplying etc. to 13 can be performed. Breaking down 13 into 1 and 3 and then performing mathematical operations on 1 and 3 is not allowed.)

- Ans
- 1. 228
  - 2. 234
  - 3. 232
  - 4. 230

Q.25 Three statements are followed by conclusions numbered I, II. You have to consider these statements to be true, even if they seem to be at variance with commonly known facts. Decide which of the given conclusions logically follow/s from the given statement.

Statements:

Some bags are paper.

All wood is paper.

Some bags are dolls.

Conclusion (I): All dolls are paper.

Conclusion (II): Some bags are wood.

- Ans
- 1. Both conclusions (I) and (II) follow.
  - 2. Neither conclusion (I) nor (II) follows.
  - 3. Only conclusion (II) follows.
  - 4. Only conclusion (I) follows.



Q.1 Study the given graph and answer the question that follows.

The graph shows the marks obtained by Riya and Rida in six subjects in the CBSE 12<sup>th</sup> exam. The maximum marks in Maths, Physics and Chemistry are 140, and that in English, IP, Biology are 180

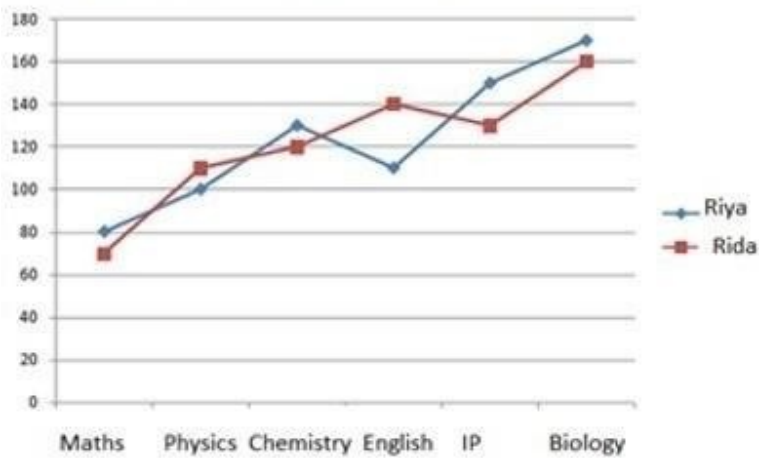

What is the percentage of marks obtained by Riya in Chemistry?

- Ans
- 1. 95.87%
  - 2. 92.86%
  - 3. 99.38%
  - 4. 92.68%

Q.2 Ramu used to spend 72% of his income. His income has increased by 12%, and he increases his expenditure by 5%. If Ramu earlier saved  $y$  and after the increases he now saves  $x$ , then what is the value of  $(\frac{x-y}{y} \times 100)\%$ ?

- Ans
- 1. 25%
  - 2. 22%
  - 3. 27%
  - 4. 30%

Q.3 The ratio of the lateral surface area to the total surface area of a cylinder with base diameter 60cm and height 10 cm is:

- Ans
- 1. 1:9
  - 2. 1:7
  - 3. 1:4
  - 4. 1:3

Q.4 If  $\cot \theta = \frac{3}{4}$ ,  $\theta$  is an acute angle, then  $\sin \theta + \cos \theta - \tan \theta$  is equal

to:

- Ans
- 1.  $\frac{1}{11}$
  - 2.  $\frac{1}{15}$
  - 3.  $\frac{1}{13}$
  - 4.  $\frac{1}{18}$

Q.5 A man bought 4 books for ₹50 each, 5 books for ₹60 each and 6 books for ₹70 each. The average cost of a book for the man is (round up to two decimal places):

- Ans
- 1. ₹36.33
  - 2. ₹50.33
  - 3. ₹61.33
  - 4. ₹60.33

Q.6 A student has 5 subjects in an examination. The distribution of hard work of 16 hours a day over 5 subjects and marks obtained 400 out of 500 are shown in the charts.



How much time did the student spend on Math and how much marks were obtained in math?

- Ans
- 1. 9.6 hrs and 84 marks
  - 2. 6.4 hrs and 84 marks
  - 3. 40 hrs and 21 marks
  - 4. 6.4 hrs and 90 marks

Q.7 From a circle, a sector with a central angle of  $30^\circ$  is cut off. If the length of the arc of this sector is 5.5 cm, then find the radius (in cm) of the circle.

[Use  $\pi = \frac{22}{7}$ .]

- Ans
- 1. 12
  - 2. 10
  - 3. 10.5
  - 4. 11

Q.8 The following table shows the production of food grains in a country over the five years.

Year	Production (in ten lakh tonnes)			
	Wheat	Rice	Maize	Other grains
2016-17	650	250	200	450
2017-18	800	440	240	400
2018-19	680	390	220	500
2019-20	700	400	260	480
2020-21	640	440	300	520

The difference between the average production (in ten lakh tonnes) of wheat and maize over the years is:

- Ans
- 1. 140
  - 2. 310
  - 3. 450
  - 4. 224

Q.9 For what positive values of  $k$  do the following pair of linear equations have infinitely many solutions?

$$kx + 3y - (k - 3) = 0$$

$$12x + ky - k = 0$$

- Ans
- 1. 6
  - 2. 2
  - 3. 12
  - 4. 4

Q.10 The following bar graph represents the production of three types of buses by a company over the years (in thousands).

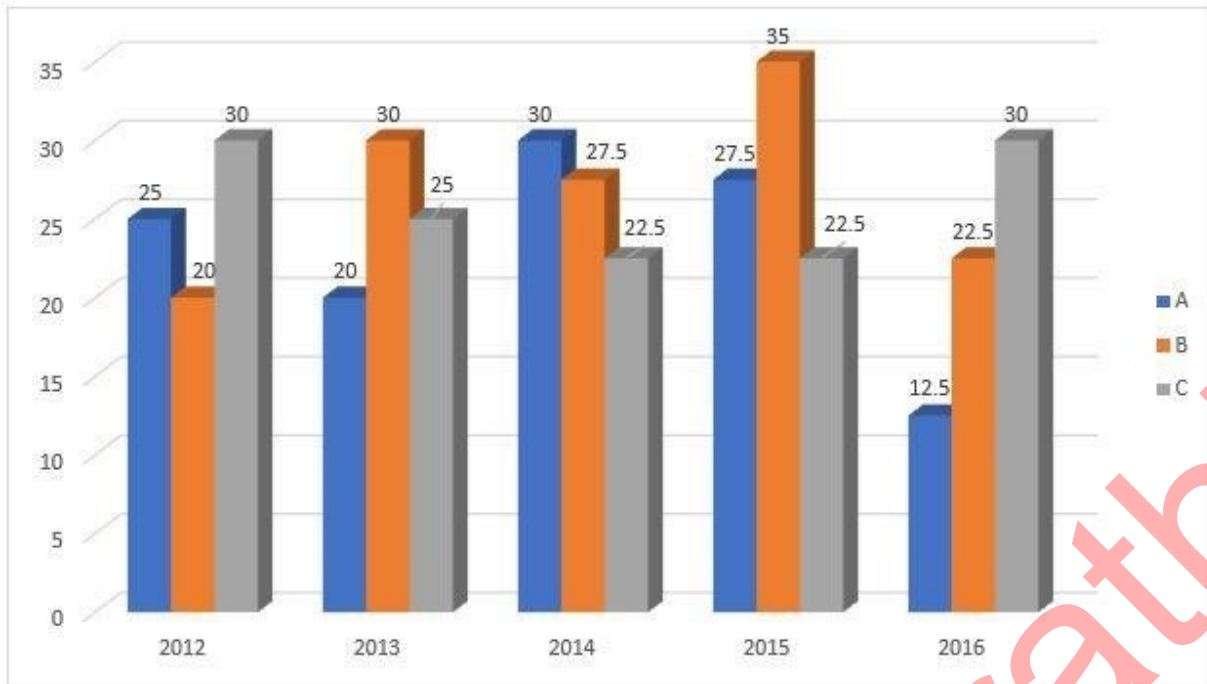

In which of the following years was the percentage production of B type buses to C type buses, the maximum?

- Ans
- 1. 2015
  - 2. 2013
  - 3. 2016
  - 4. 2014

Q.11 If the price of tea is increased by 40%, by how what percentage must the consumption of tea be decreased so as not to increase the expenditure?

- Ans
- 1.  $15\frac{2}{9}\%$
  - 2.  $31\frac{3}{5}\%$
  - 3.  $35\frac{9}{2}\%$
  - 4.  $28\frac{4}{7}\%$

Q.12 If the height of a solid right circular cylinder is 27 cm and diameter of its base is 30 cm, the total surface area (in  $cm^2$ ) of the right circular cylinder is:

Take  $\pi = \frac{22}{7}$

- Ans
- 1. 3976
  - 2. 3964
  - 3. 3978
  - 4. 3960

Q.13 Akhil can complete a piece of work in 24 days. Shyam can complete the same piece of work in 12 days. If both of them work together, in how many days can they complete the same piece of work?

- Ans
- 1. 12 days
  - 2. 6 days
  - 3. 10 days
  - 4. 8 days

Q.14 An amount of ₹8,000 was invested for 2 years, partly in scheme 1 at the rate of 5% simple interest per annum and the rest in scheme 2 at the rate of 4% simple interest per annum. The total interest received at the end was ₹720. The amount of money invested in scheme 1 is:

- Ans
- 1. ₹3,640
  - 2. ₹7,200
  - 3. ₹4,400
  - 4. ₹4,000

Q.15 In a circle, O is the centre and AOB is the diameter. AT is a tangent to the circle. Line TB intersects the circle at Q. Given that  $\angle AOQ = 94^\circ$ , find  $\angle ATQ$ .

- Ans
- 1.  $86^\circ$
  - 2.  $43^\circ$
  - 3.  $47^\circ$
  - 4.  $133^\circ$

Q.16 In a 100-m race, A beats B by 20 m and B beats C by 5 m. In the same race, find the distance by which A beats C.

- Ans
- 1. 22 m
  - 2. 24 m
  - 3. 26 m
  - 4. 25 m

Q.17 A shopkeeper buys 1800 kg wheat for ₹32,400. If 20% of this wheat is spoiled due to rain, at what rate (₹/kg) should he sell the rest to earn 20%?

- Ans
- 1. 29
  - 2. 26
  - 3. 25
  - 4. 27

Q.18 Simplify the given expression.

$$\left[ 3 \times 6 - 3 \left\{ 2 \left( 2 \div \frac{1}{2} - 2 \right) + 2 \div \frac{1}{2} \right\} - 18 \right]$$

- Ans
- 1. 24
  - 2. 18
  - 3. -24
  - 4. -18

Q.19 A 35% profit is made when a discount of 35% is given on the marked price of an item. When the discount is 45%, then the profit percentage will be:

- Ans
- 1.  $17\frac{1}{13}\%$
  - 2.  $11\frac{3}{13}\%$
  - 3.  $14\frac{3}{13}\%$
  - 4.  $13\frac{3}{17}\%$

Q.20 Two parallel chords of length 5 units and 8 units are on opposite sides of the center of a circle of radius 7 units. What is the distance between the chords? (round your answer to two decimal places)

- Ans
- 1. 11.82 units
  - 2. 12.28 units
  - 3. 11.28 units
  - 4. 12.82 units

Q.21 In a triangle ABC, AB = AC. BC is extended to D such that CD = AB and the angle ADC is  $30^\circ$ . What are the angles of triangle ABC?

- Ans
- 1.  $30^\circ, 60^\circ, 90^\circ$
  - 2.  $50^\circ, 60^\circ, 70^\circ$
  - 3.  $60^\circ, 60^\circ, 60^\circ$
  - 4.  $45^\circ, 60^\circ, 75^\circ$

Q.22 If the income of Neha is 5% more than that of Monica, then the income of Monica is what percentage less than that of Neha?

- Ans
- 1.  $4\frac{5}{21}\%$
  - 2.  $4\frac{13}{21}\%$
  - 3.  $4\frac{11}{21}\%$
  - 4.  $4\frac{16}{21}\%$

Q.23 A mixture contains alcohol and water in the ratio of 12 : 5. On adding 14 liters of water, the ratio of alcohol to water becomes 4 : 3. The quantity of alcohol in the mixture is:

- Ans
- 1. 18 L
  - 2. 28 L
  - 3. 30 L
  - 4. 42 L

Q.24 What is the smallest number that must be added to 19487161 so that it is divisible by 11?

- Ans
- 1. 11
  - 2. 5
  - 3. 16
  - 4. 10

**Q.25** 3 solid spheres of diameters 6 cm, 8 cm and 10 cm are melted together to form a single solid sphere. Find its radius.

- Ans**
- 1. 12 cm
  - 2. 9 cm
  - 3. 3 cm
  - 4. 6 cm

Section : General Awareness

**1. Which part of the Constitution of India deals with 'Citizenship'?**

- Ans**
- 1. Part I
  - 2. Part III
  - 3. Part IV
  - 4. Part II

**2. In a symport:**

- Ans**
- 1. a molecule moves across a membrane independent of other molecules
  - 2. both molecules cross the membrane in the same direction
  - 3. both molecules cross the membrane in the opposite direction
  - 4. a molecule moves across a membrane dependent of other molecules

**3. The Braj festival in \_\_\_\_\_ is held every year for two days in the Shukla Paksha of the Phalgun month, a few days before Holi.**

- Ans**
- 1. Rajasthan
  - 2. Himachal Pradesh
  - 3. Madhya Pradesh
  - 4. Haryana

**Q.4 The Kailasha temple at Ellora near Aurangabad in Maharashtra was built by a king from the \_\_\_\_\_ Dynasty.**

- Ans**
- 1. Rashtrakuta
  - 2. Pratihara
  - 3. Gurjara Pratihara
  - 4. Chandella

**Q.5 Where and when was India's first Senior National Archery Championship held?**

- Ans**
- 1. Delhi, 1973
  - 2. Chennai, 1973
  - 3. Chennai, 1975
  - 4. Delhi, 1975

**Q.6 Which of the following persons was sworn in as chief of the Central Information Commission of India in November 2023?**

- Ans**
- 1. Bimal Julka
  - 2. Yashovardhan Azad
  - 3. Divya Prakash Sinha
  - 4. Heeralal Samariya

**Q.7 Which of the following committees had recommended the inclusion of a chapter on the Fundamental Duties in the Constitution of India and stressed that the citizens should become conscious that, in addition to the enjoyment of rights, they also have certain duties to perform?**

- Ans**
- 1. Balwant Rai Mehta Committee (1976)
  - 2. JR Varma Committee (1996)
  - 3. Ashok Mehta Committee (1977)
  - 4. Swaran Singh Committee (1976)

Q.8 Which of the following is NOT an alignment option for text in a cell?

- Ans
- 1. Center
  - 2. Right
  - 3. Justified
  - 4. Left

Q.9 The Thomas Cup is associated with which of the following sports?

- Ans
- 1. Badminton female
  - 2. Tennis female
  - 3. Tennis male
  - 4. Badminton male

Q.10 Which of the following is the most dominant species of the Tropical Deciduous Forests?

- Ans
- 1. Mulberry
  - 2. Rubber
  - 3. Coconut
  - 4. Teak

Q.11 Which of the following song did AR Rahman record with Michael Jackson?

- Ans
- 1. Ekam Satyam
  - 2. You are my destiny
  - 3. The Oracle
  - 4. Infinity Love

Q.12 \_\_\_\_\_ is one of the well-known schemes sponsored by the Union Government of India. It was launched in November 2015 with the aim of rescuing the country's ailing electricity distribution companies.

- Ans
- 1. Integrated Power Development Scheme (IPDS)
  - 2. One Nation, One Grid
  - 3. Deendayal Upadhyaya Gram Jyoti Yojana
  - 4. Ujwal DISCOM Assurance Yojana

Q.13 Which of the following statements is/are FALSE about the Special Economic Zones (SEZs) of India?

- i. One of the main objectives of the Zones Act was promotion of exports of goods and services.
- ii. The Government of India announced the Special Economic Zones (SEZs) Policy in the year 2011.
- iii. The SEZ Rules provided for different minimum land requirement for different classes of SEZs.

- Ans
- 1. Only ii
  - 2. Only i and ii
  - 3. Only ii and iii
  - 4. Only iii

Q.14 Which of the following tribes does NOT live in India?

- Ans
- 1. Maasai
  - 2. Tharu
  - 3. Gond
  - 4. Santhal



Q.15 How can we add text to a slide in MS-PowerPoint?

- Ans
- 1. Note box
  - 2. Dialogue box
  - 3. Notes page
  - 4. Textbox

Q.16 Who was the first to use the term 'horsepower' that refers to the power produced by an engine?

- Ans
- 1. John Dalton
  - 2. Amedeo Avogadro
  - 3. Albert Einstein
  - 4. James Watt

Q.17 Which of the following is NOT a moon of Jupiter?

- Ans
- 1. Triton
  - 2. Callisto
  - 3. Europa
  - 4. Ganymede

Q.18 Under the discretionary power of which Article of the Indian Constitution did the SC of India recognise sex work as a profession?

- Ans
- 1. Article 142
  - 2. Article 143
  - 3. Article 141
  - 4. Article 140

Q.19 Which of the following pairs of state and folk dance is correctly paired?

- Ans
- 1. Punjab – Bhangra dance
  - 2. Haryana – Garia or Gorla dance
  - 3. Kerala – Ghoomar dance
  - 4. Gujarat – Bihu dance

Q.20 On the basis of highest population growth rate (Census, 2011), select the option that arranges the following states in descending order.

- A) Bihar  
B) Arunachal Pradesh  
C) Meghalaya

- Ans
- 1. C, B, A
  - 2. A, B, C
  - 3. C, A, B
  - 4. B, C, A

Q.21 Former Union Minister \_\_\_\_\_ from Manipur was awarded Padma Shri in 2023 by the Union government for his contribution in public affairs in the last four decades.

- Ans
- 1. Thokchom Radheshyam Singh
  - 2. Thounaojam Chaoba
  - 3. Yumnam Joykumar
  - 4. Okram Ibobi Singh

Q.22 National income at constant prices means:

- Ans
- 1. income estimated for next year prices
  - 2. income estimated at base year prices
  - 3. income estimated at current year prices
  - 4. income estimated at any year prices

Q.23 Who composed the music of the patriotic song 'Maa Tujhe Salaam'?

- Ans
- 1. Anu Malik
  - 2. Shankar Mahadevan
  - 3. Himesh Reshammiya
  - 4. AR Rahman

Q.24 Where did the indigenous sport 'Gatka' originate from?

- Ans
- 1. Rajasthan
  - 2. Manipur
  - 3. Punjab
  - 4. Jammu and Kashmir

Q.25 The birthday of \_\_\_\_\_ is celebrated as the International Day of Non-Violence.

- Ans
- 1. Bhimrao Ambedkar
  - 2. Mahatma Gandhi
  - 3. Sardar Vallabhbhai Patel
  - 4. Rabindranath Tagore

Adda247 Marathi

## Combined Higher Secondary Level Examination 2024 Tier I

Exam Date	05/07/2024
Exam Time	9:00 AM - 10:00 AM
Subject	CHSL Exam 2024 Tier I

### Section : English Language

1. The following sentence has been divided into four parts. Identify the part that contains an error. This is / a doll / and there is / a umbrella.

Ans  1. This is  
 2. a doll  
 3. and there is  
 4. a umbrella.

2. The following sentence has been divided into parts. One of them may contain an error. Select the part that contains the error from the given options. If you don't find any error mark 'No error' as your answer. The aeroplane took down / without the passengers after / making a sudden announcement.

Ans  1. making a sudden announcement  
 2. No error  
 3. without the passengers after  
 4. The aeroplane took down

3. The following sentence has been split into four segments. Identify the segment that contains an error. She shall being / travelling / by this time / tomorrow.

Ans  1. travelling  
 2. She shall being  
 3. by this time  
 4. tomorrow

- Q.4 Parts of the following sentence have been given as options. Select the option that contains an error. Emily is a American living in Paris for her work.

Ans  1. a American  
 2. living in Paris  
 3. Emily is  
 4. for her work

**Comprehension:**

In the following passage, some words have been deleted. Read the passage carefully and select the most appropriate option to fill in each blank.

The Sun is about 1.4 million kilometres (1)\_\_\_\_\_diameter, while the Earth is about 13,000 kilometers wide. This indicates that the Sun's width would need to be filled by more than one hundred Earths. Sunspots are dreary (2)\_\_\_\_\_on the Sun's surface that are two thousand degrees Celsius cooler than the rest of the surface. The coolest piece of the sunspot is the dim focus called the umbra. The penumbra surrounds it. On the Sun's surface, some sunspots are just specks. Additionally, they appear in groups up to ten times larger than Earth. They can sometimes reach 200,000 miles in length. As the Sun rotates, these groups (3)\_\_\_\_\_to travel across the Sun over two weeks. Every 11 years, the number of sunspots reaches its maximum. The solar or sunspot cycle (4)\_\_\_\_\_to this. The Earth's weather may become more extreme and warm during the peak of sunspot activity. According to the (5)\_\_\_\_\_made by satellites like Nimbus 7, when sunspots are at their largest, less heat reaches Earth.

**SubQuestion No : 5**

**Q.5** Select the most appropriate option to fill in blank number 1.

- Ans**
- 1. in
  - 2. of
  - 3. on
  - 4. at

**Comprehension:**

In the following passage, some words have been deleted. Read the passage carefully and select the most appropriate option to fill in each blank.

The Sun is about 1.4 million kilometres (1)\_\_\_\_\_diameter, while the Earth is about 13,000 kilometers wide. This indicates that the Sun's width would need to be filled by more than one hundred Earths. Sunspots are dreary (2)\_\_\_\_\_on the Sun's surface that are two thousand degrees Celsius cooler than the rest of the surface. The coolest piece of the sunspot is the dim focus called the umbra. The penumbra surrounds it. On the Sun's surface, some sunspots are just specks. Additionally, they appear in groups up to ten times larger than Earth. They can sometimes reach 200,000 miles in length. As the Sun rotates, these groups (3)\_\_\_\_\_to travel across the Sun over two weeks. Every 11 years, the number of sunspots reaches its maximum. The solar or sunspot cycle (4)\_\_\_\_\_to this. The Earth's weather may become more extreme and warm during the peak of sunspot activity. According to the (5)\_\_\_\_\_made by satellites like Nimbus 7, when sunspots are at their largest, less heat reaches Earth.

**SubQuestion No : 6**

**Q.6** Select the most appropriate option to fill in blank number 2.

- Ans**
- 1. regions
  - 2. section
  - 3. belt
  - 4. province

**Comprehension:**

In the following passage, some words have been deleted. Read the passage carefully and select the most appropriate option to fill in each blank.

The Sun is about 1.4 million kilometres (1)\_\_\_\_\_diameter, while the Earth is about 13,000 kilometers wide. This indicates that the Sun's width would need to be filled by more than one hundred Earths. Sunspots are dreary (2)\_\_\_\_\_on the Sun's surface that are two thousand degrees Celsius cooler than the rest of the surface. The coolest piece of the sunspot is the dim focus called the umbra. The penumbra surrounds it. On the Sun's surface, some sunspots are just specks. Additionally, they appear in groups up to ten times larger than Earth. They can sometimes reach 200,000 miles in length. As the Sun rotates, these groups (3)\_\_\_\_\_to travel across the Sun over two weeks. Every 11 years, the number of sunspots reaches its maximum. The solar or sunspot cycle (4)\_\_\_\_\_to this. The Earth's weather may become more extreme and warm during the peak of sunspot activity. According to the (5)\_\_\_\_\_made by satellites like Nimbus 7, when sunspots are at their largest, less heat reaches Earth.

**SubQuestion No : 7**

**Q.7** Select the most appropriate option to fill in blank number 3.

- Ans**
- 1. act
  - 2. show
  - 3. shape
  - 4. appear

**Comprehension:**

In the following passage, some words have been deleted. Read the passage carefully and select the most appropriate option to fill in each blank.

The Sun is about 1.4 million kilometres (1)\_\_\_\_\_diameter, while the Earth is about 13,000 kilometers wide. This indicates that the Sun's width would need to be filled by more than one hundred Earths. Sunspots are dreary (2)\_\_\_\_\_on the Sun's surface that are two thousand degrees Celsius cooler than the rest of the surface. The coolest piece of the sunspot is the dim focus called the umbra. The penumbra surrounds it. On the Sun's surface, some sunspots are just specks. Additionally, they appear in groups up to ten times larger than Earth. They can sometimes reach 200,000 miles in length. As the Sun rotates, these groups (3)\_\_\_\_\_to travel across the Sun over two weeks. Every 11 years, the number of sunspots reaches its maximum. The solar or sunspot cycle (4)\_\_\_\_\_to this. The Earth's weather may become more extreme and warm during the peak of sunspot activity. According to the (5)\_\_\_\_\_made by satellites like Nimbus 7, when sunspots are at their largest, less heat reaches Earth.

**SubQuestion No : 8**

**Q.8** Select the most appropriate option to fill in blank number 4.

- Ans**
- 1. refers
  - 2. pass
  - 3. cite
  - 4. entrust

**Comprehension:**

In the following passage, some words have been deleted. Read the passage carefully and select the most appropriate option to fill in each blank.

The Sun is about 1.4 million kilometres (1)\_\_\_\_\_diameter, while the Earth is about 13,000 kilometers wide. This indicates that the Sun's width would need to be filled by more than one hundred Earths. Sunspots are dreary (2)\_\_\_\_\_on the Sun's surface that are two thousand degrees Celsius cooler than the rest of the surface. The coolest piece of the sunspot is the dim focus called the umbra. The penumbra surrounds it. On the Sun's surface, some sunspots are just specks. Additionally, they appear in groups up to ten times larger than Earth. They can sometimes reach 200,000 miles in length. As the Sun rotates, these groups (3)\_\_\_\_\_to travel across the Sun over two weeks. Every 11 years, the number of sunspots reaches its maximum. The solar or sunspot cycle (4)\_\_\_\_\_to this. The Earth's weather may become more extreme and warm during the peak of sunspot activity. According to the (5)\_\_\_\_\_made by satellites like Nimbus 7, when sunspots are at their largest, less heat reaches Earth.

**SubQuestion No : 9**

**Q.9** Select the most appropriate option to fill in blank number 5.

- Ans**
- 1. perceptions
  - 2. inspections
  - 3. observations
  - 4. invalidations

**Q.10** Select the most appropriate option that can substitute the underlined word segment in the following sentence.  
They are leaving there coats there.

- Ans**
- 1. their coats there
  - 2. they're coats there
  - 3. there coats their
  - 4. their coats their

**Q.11** Select the most appropriate synonym of the word 'Swap' from the given sentence.

The original buyer attempted to resell the tickets online because there was no option to exchange them for a new date.

- Ans**
- 1. resell
  - 2. exchange
  - 3. original
  - 4. option

**Q.12** Select the most appropriate ANTONYM for the underlined word in the given sentence.  
He feels that wealthy people view him with contempt because he is poor.

- Ans**
- 1. Derision
  - 2. Admiration
  - 3. Scorn
  - 4. Obscurity

Q.13 Select the most appropriate option to fill in the blank.

She went on a shopping spree with her friend and made him \_\_\_\_\_ the fat bill.

- Ans
- 1. paid
  - 2. do
  - 3. pay
  - 4. give

Q.14 Identify the incorrectly spelt word and select its correct spelling.  
You shall recieve proper pay for your work.

- Ans
- 1. resieve
  - 2. propper
  - 3. receive
  - 4. propeer

Q.15 Select the most appropriate ANTONYM of the given word.

Transient

- Ans
- 1. Permanent
  - 2. Transparent
  - 3. Transitory
  - 4. Irregular

Q.16 Select the most appropriate ANTONYM of the given word.  
Innocent

- Ans
- 1. Guilty
  - 2. Mischievous
  - 3. Unfair
  - 4. Righteous

Q.17 Select the correct spelling of the underlined word.  
He is one of the most underated players in the team.

- Ans
- 1. Undereted
  - 2. Underatted
  - 3. Underrated
  - 4. Underreted

Q.18 Select the most appropriate meaning of the given idiom.

To be at daggers drawn

- Ans
- 1. To be about to collapse
  - 2. Ready to fight
  - 3. Under suspicion
  - 4. To be under control

Q.19 The following sentence has been split into four segments. Identify the segment that contains a grammatical error. The hotel room, / which we / booked, / isn't enough big.

- Ans
- 1. isn't enough big
  - 2. The hotel room
  - 3. which we
  - 4. booked,

Q.20 Select the most appropriate synonym of the given word.

Appalled

- Ans
- 1. Applied
  - 2. Clap
  - 3. Disgusted
  - 4. Allied

Q.21 Select the most appropriate ANTONYM of the given word.  
Cramped

- Ans
- 1. Filthy
  - 2. Spacious
  - 3. Tight
  - 4. Crammed

Q.22 Select the most appropriate option that can substitute the underlined word in the given sentence.  
Even in cold weather, the reliable car always started on the first try.

- Ans
- 1. dependable
  - 2. inaccurate
  - 3. erratic
  - 4. flaky

Q.23 Select the most appropriate meaning of the given idiom.  
To cost an arm and a leg

- Ans
- 1. Someone is badly hurt
  - 2. Something is very expensive
  - 3. Someone does not have money to buy something
  - 4. Someone has borne losses

Q.24 Select the most appropriate ANTONYM of the underlined word.

The news gave him inexpressible ecstasy.

- Ans
- 1. Delight
  - 2. Passion
  - 3. Depression
  - 4. Disappointment

Q.25 Select the most appropriate option that can substitute the underlined segment in the given sentence.

Mrs. Lakshmi's purchases add around to ₹2,650.

- Ans
- 1. purchases add out to
  - 2. purchases add from to
  - 3. purchases add up to
  - 4. purchases add for to

Q.1 Select the correct mirror image of the given figure when the mirror is placed at MN as shown below.

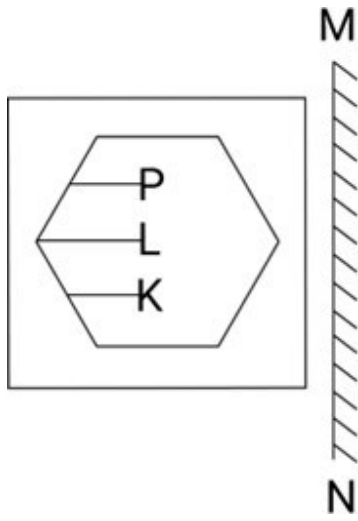

Ans

✓ 1.

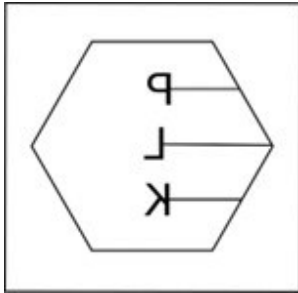

✗ 2.

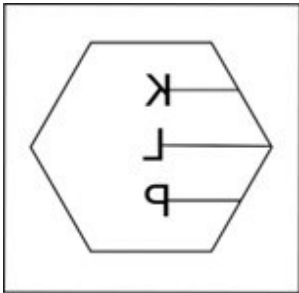

✗ 3.

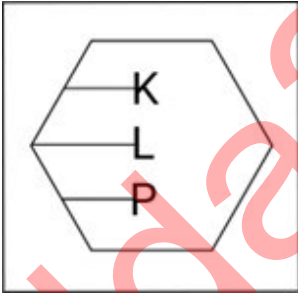

✗ 4.

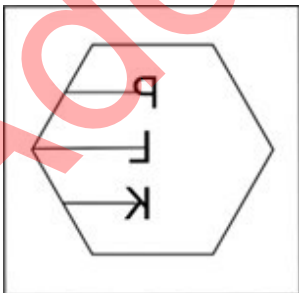



Q.2 Select the set in which the numbers are related in the same way as are the numbers of the following sets.

(11, 8, 352)  
(15, 6, 360)

(NOTE : Operations should be performed on the whole numbers, without breaking down the numbers into its constituent digits. E.g. 13 – Operations on 13 such as adding /subtracting /multiplying etc., to 13 can be performed. Breaking down 13 into 1 and 3 and then performing mathematical operations on 1 and 3 is not allowed.)

- Ans
- 1. (11, 7, 231)
  - 2. (8, 9, 352)
  - 3. (16, 5, 320)
  - 4. (17, 6, 102)

3. Which two numbers should be interchanged to make the given equation correct?

$$(99 - 42 + 11) + (36 \div 6) \times 7 - 50 = 73$$

(NOTE: Numbers must be interchanged and not the constituent digits e.g. if 2 and 3 are to be interchanged in the equation  $43 \times 3 + 4 \div 2$ , then interchanged equation is  $43 \times 2 + 4 \div 3$ )

- Ans
- 1. 50 and 99
  - 2. 50 and 11
  - 3. 7 and 11
  - 4. 42 and 36

Q.4 Select the correct mirror image of the given combination when the mirror is placed at MN as shown below.

M  
|  
V b 7 2 m R  
|  
N

- Ans
- 1. R m  $\Sigma$   $\nabla$  d  $\Lambda$
  - 2. R m  $\Sigma$   $\nabla$  d V
  - 3. 2 m R  $\nabla$  d V
  - 4. R m  $\Sigma$   $\nabla$  d V

Q.5 Select the correct mirror image of the given figure when the mirror is placed at MN.

M  
|  
R 4 b m L 2  
|  
N

- Ans
- 1. R 4 b m L 2
  - 2. R 4 b m L 2
  - 3.  $\Sigma$  J m d  $\nabla$  R
  - 4.  $\Sigma$  J m d  $\nabla$  R

Q.6 If 4 December 2014 was Thursday, then what was the day of the week on 10 December 2018?

- Ans
- 1. Wednesday
  - 2. Tuesday
  - 3. Monday
  - 4. Friday

Q.7 If 18 August 2000 was Friday, then what was the day of the week on 21 August 2005?

- Ans
- 1. Friday
  - 2. Wednesday
  - 3. Monday
  - 4. Sunday

Q.8 Select the option in which the given figure is embedded. (Rotation is NOT allowed.)

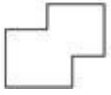

- Ans
- 1.
  - 2.
  - 3.
  - 4.

Q.9 What should come in place of ? in the given series based on the English alphabetical order?

OWL QAQ ? UIA WMF

- Ans
- 1. XMB
  - 2. SEV
  - 3. LQJ
  - 4. PNL

Q.10 In a certain code language, 'BAKE' is coded as '2496' and 'CAKE' is coded as '4369'. How is 'B' coded in that language?

- Ans
- 1. 6
  - 2. 2
  - 3. 4
  - 4. 9

Q.11 LJNR is related to IGLP in a certain way based on the English alphabetical order. In the same way, FDHL is related to CAFJ. To which of the following is HFJN related, following the same logic?

- Ans
- 1. EDHL
  - 2. EDGL
  - 3. EBIL
  - 4. ECHL

Q.12 If 'A' stands for '+', 'B' stands for 'x', 'C' stands for '+' and 'D' stands for '-', then the resultant of which of the following will be 1049?

- Ans
- 1. 94 D 11 B 180 A 4 C 60
  - 2. 94 A 11 D 180 B 4 C 60
  - 3. 94 C 11 D 180 A 4 B 60
  - 4. 94 B 11 D 180 A 4 C 60

Q.13 What should come in place of the question mark (?) in the given series?

32, 61, 90, 119, ?, 177

- Ans
- 1. 148
  - 2. 147
  - 3. 149
  - 4. 146

Q.14 If 'A' stands for '+', 'B' stands for '×', 'C' stands for '÷' and 'D' stands for '−', what will come in place of the question mark (?) in the following equation?

35 B 7 D 120 A 12 C 38 = ?

- Ans
- 1. 173
  - 2. 473
  - 3. 373
  - 4. 273

Q.15 NGPZ is related to JCLV in a certain way based on the English alphabetical order. In the same way, XDLM is related to TZHI. To which of the following is RUKV related, following the same logic?

- Ans
- 1. NQRG
  - 2. NGRQ
  - 3. NQGR
  - 4. NGQR

Q.16 Select the combination of letters that when sequentially placed in the blanks of the given series will complete the series.

xy\_z\_xxy\_zbx\_yx\_bx\_y\_z\_x

- Ans
- 1. xbxyzxxb
  - 2. xyxxzxxb
  - 3. xzxyyzx
  - 4. xbxxzxxb

Q.17 How many triangles are there in the given figure?

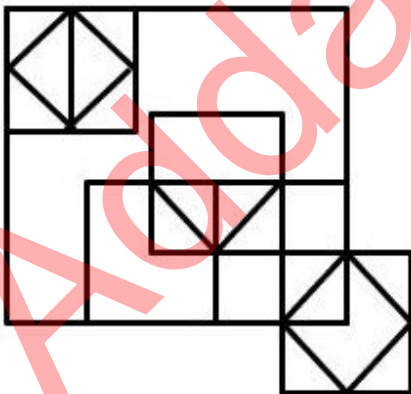

- Ans
- 1. 17
  - 2. 18
  - 3. 16
  - 4. 15

Q.18 In a certain code language  
A + B means 'A is the brother of B'  
A - B means 'A is the father of B'  
A × B means 'A is the wife of B'  
A ÷ B means 'A is the mother of B'  
Based on the above, how is P related to T if 'P ÷ Q × R - S + T'?

- Ans
- 1. Father's mother
  - 2. Father's sister
  - 3. Mother's sister
  - 4. Mother's mother

Q.19 161 is related to 23 following a certain logic. Following the same logic, 301 is related to 43. To which of the following is 427 related following the same logic?  
(NOTE : Operations should be performed on the whole numbers, without breaking down the numbers into its constituent digits. E.g. 13 - Operations on 13 such as adding /deleting /multiplying etc., to 13 can be performed. Breaking down 13 into 1 and 3 and then performing mathematical operations on 1 and 3 is not allowed.)

- Ans
- 1. 63
  - 2. 59
  - 3. 57
  - 4. 61

Q.20 Which two numbers should be interchanged to make the given equation correct?

$$69 + 15 - (14 \times 4) \div 2 + (48 \div 3) = 58$$

(NOTE: Numbers must be interchanged and not the constituent digits e.g. if 2 and 3 are to be interchanged in the equation  $43 \times 3 + 4 \div 2$ , then interchanged equation is  $43 \times 2 + 4 \div 3$ )

- Ans
- 1. 69 and 48
  - 2. 4 and 2
  - 3. 3 and 4
  - 4. 48 and 15

Q.21 A paper is folded and cut as shown below. How will it appear when unfolded?

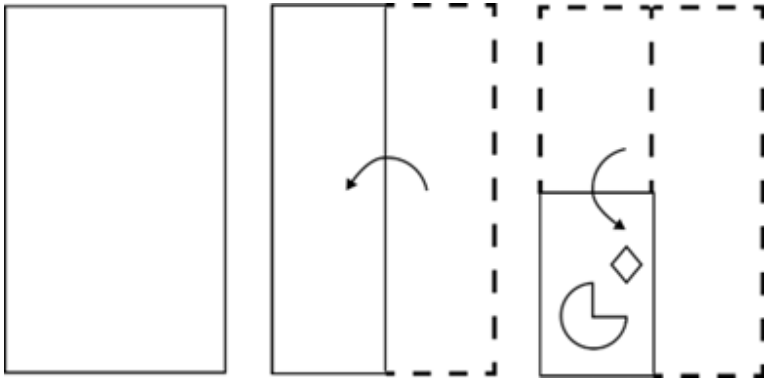

Ans

X 1.

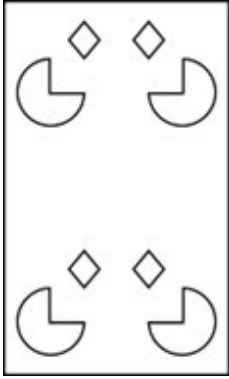

X 2.

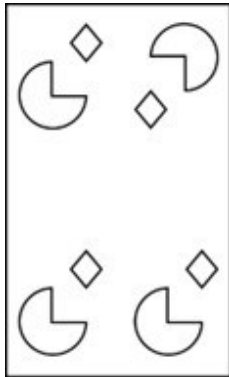

X 3.

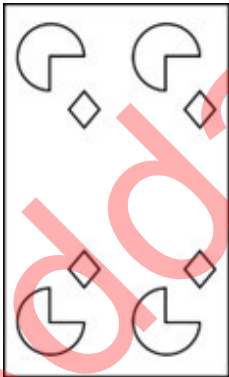

✓ 4.

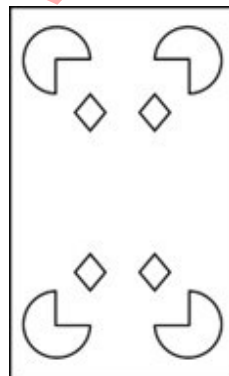

Q.22 In a certain code language, 'CODE' is coded as '1573' and 'DICE' is coded as '7185'. How is 'O' coded in the given language?

- Ans
- 1. 8
  - 2. 7
  - 3. 5
  - 4. 3

Q.23 In this question, three statements are given, followed by three conclusions numbered I, II and III. Assuming the statements to be true, even if they seem to be at variance with commonly known facts, decide which of the conclusion(s) logically follows/follow from the statements.

Statements:

Some strawberries are oranges.

Some oranges are kiwis.

All kiwis are melons.

Conclusions:

I. No strawberry is a melon.

II. All strawberries are melons.

III. Some strawberries are kiwis.

- Ans
- 1. Both conclusions II and III follow.
  - 2. All conclusions I, II and III follow.
  - 1. Neither conclusions I, II nor III follows.
  - 2. Both conclusions I and II follow.

Q.24 Identify the figure given in the options which when put in place of the question mark (?) will logically complete the series?

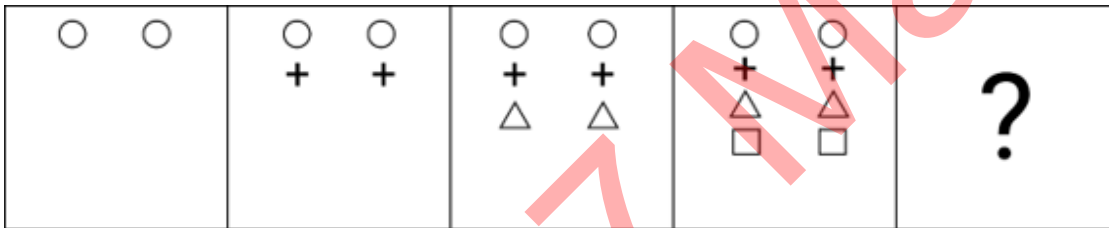

Ans

1.

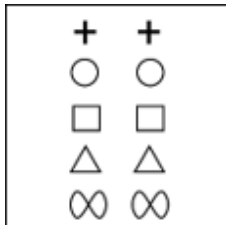

2.

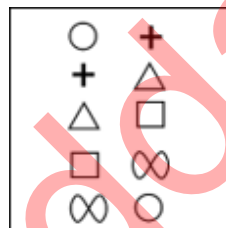

3.

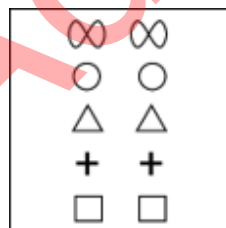

4.

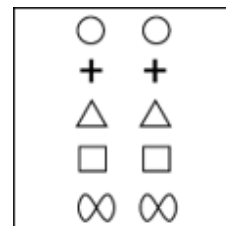

Q.25 Three of the following four are alike in a certain way and thus form a group. Which is the one that does NOT belong to that group?

(Note: The odd one out is not based on the number of consonants/vowels or their position in the letter cluster.)

- Ans
- 1. DGL
  - 2. QTY
  - 3. MPU
  - 4. FIM

Section : Quantitative Aptitude

Q.1 Sapna finishes a job in 12 hours working alone. If Sapna and Riya finish the same job in 8 hours working together at their respective constant rates, then, in how many hours can Riya do the job working alone?

- Ans
- 1. 18
  - 2. 24
  - 3. 16
  - 4. 20

Q.2 If  $\tan A = a \tan B$  and  $\sin A = b \sin B$ , then the value of  $\cos^2 A$  is:

- Ans
- 1.  $\frac{b^2 - 1}{a^2 - 1}$
  - 2.  $\frac{a^2 - 1}{b^2 - 1}$
  - 3.  $\frac{b^2 + 1}{a^2 + 1}$
  - 4.  $\frac{a^2 + 1}{b^2 + 1}$

3. The distance between the centres of two circles of radii 7 cm and 5 cm is 15 cm. Find the length of the transverse common tangent to these circles.

- Ans
- 1. 7 cm
  - 2. 13 cm
  - 3. 11 cm
  - 4. 9 cm

Q.4 A coffee maker with marked price ₹4,000 is available on successive discounts of 15%, 10% and 5%. Find the selling price of the coffee maker.

- Ans
- 1. ₹2,900
  - 2. ₹2,903
  - 3. ₹2,905
  - 4. ₹2,907

Q.5 A girl walking at a speed of 9 km/h crosses a bridge in 45 minutes. Find the length of the bridge in metres.

- Ans
- 1. 6349
  - 2. 6398
  - 3. 6750
  - 4. 7532

**Q.6** Rajesh is playing with a football having diameter of 28 cm. He wants to get a photo of his favourite player painted on the entire ball. The painter charges ₹2/cm<sup>2</sup>. What will be the cost (in ₹) of painting the ball (take  $\pi = \frac{22}{7}$ )?

- Ans**
- 1. 4,928
  - 2. 4,828
  - 3. 2,414
  - 4. 2,464

**Q.7** Study the given pie chart and answer the question that follows. The given pie chart represents the percentage of valid votes obtained by five candidates in a university election.

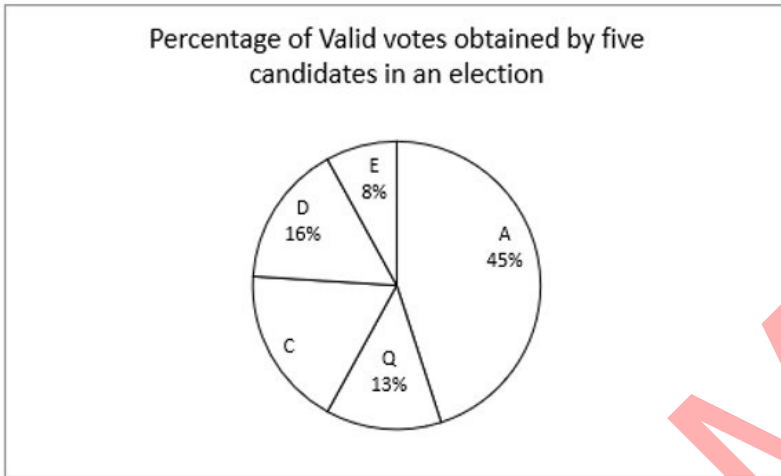

If candidate C has obtained 270 valid votes, then which are the two candidates for whom the difference in valid votes obtained is 45?

- Ans**
- 1. D and Q
  - 2. Q and C
  - 3. C and D
  - 4. A and Q

**Q.8** Study the given table and answer the questions that follow.

The table represents the number of candidates appeared, qualified, and selected in a national level examination from four different schools M, N, O and P over the years 2012 to 2017.

Where A: Appeared; Q: Qualified ; S: Selected

Year	M			N			O			P		
	A	Q	S	A	Q	S	A	Q	S	A	Q	S
2012	7000	750	84	3000	400	34	2000	250	27	1500	160	23
2013	5500	500	55	3500	420	56	2500	340	36	2500	290	56
2014	6500	455	42	3800	460	66	3500	380	48	2700	480	67
2015	8500	854	89	4500	485	72	4500	560	57	3400	540	87
2016	9000	922	92	4690	678	86	5670	660	68	3700	650	89
2017	9200	942	94	6700	700	92	6780	680	89	4500	670	93

For which school is the average number of candidates selected over the years the maximum?

- Ans**
- 1. O
  - 2. M
  - 3. N
  - 4. P



Q.9 Monthly salary of Jitvik in the month of December 2020 was ₹24,800. Every year his salary increases by 5% from the month of January. What was his salary (in ₹) in the month of February 2022?

- Ans
- 1. 27342
  - 2. 26485
  - 3. 27486
  - 4. 27180

Q.10 The population of a town first decreased by 16% due to migration to a big city for better job opportunities. The next year, the population of the town increased by 21% as there were better facilities for jobs. What is the net percentage change (correct to 2 decimal places) in the population?

- Ans
- 1. Decrease by 2.54%
  - 2. Increase by 2.54%
  - 3. Increase by 1.64%
  - 4. Decrease by 1.64%

Q.11 Simplify the following expression.

$$99 - [169 \div (13 \times 13) - (-4) - \{3 - 17 + 10\}]$$

- Ans
- 1. 80
  - 2. 87
  - 3. 107
  - 4. 90

Q.12 If  $3c2933k$  is divisible by both 5 and 11, where  $c$  and  $k$  are single digit natural numbers, then  $c + k =$  \_\_\_\_\_.

- Ans
- 1. 7
  - 2. 8
  - 3. 6
  - 4. 5

Q.13 Raju has ₹11,000 and starts saving ₹5,000 each week towards buying a new laptop. At the same time, Ramesh has ₹60,000 and begins spending ₹2,000 per week on supplies for his art class. Will there be a week when they have the same amount of money?

- Ans
- 1. Yes, after 7 weeks
  - 2. Yes, after 6 weeks
  - 3. No, they will never have the same amount
  - 4. Yes, after 5 weeks

Q.14

The following line graph shows the ratio of imports to exports of two companies over the years.

Study the graph carefully and answer the question that follows.

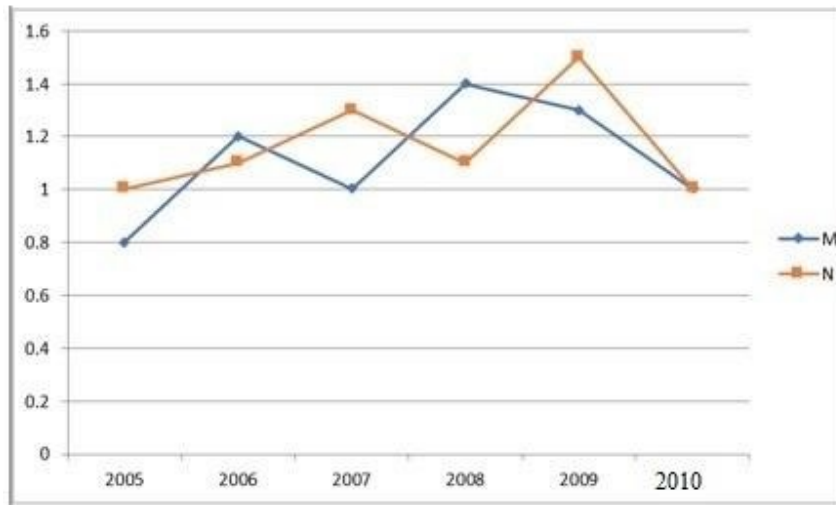

If the exports of Company M in 2008 were ₹210 crores, what were the imports of the company in the same year?

- Ans
- 1. ₹186 crores
  - 2. ₹294 crores
  - 3. ₹150 crores
  - 4. ₹268 crores

Q.15 A cylindrical oil tank has a radius of 5 m and a total surface area of  $628 \text{ m}^2$ , what would be its curved surface area? (round off to the second decimal place)

- Ans
- 1.  $371.83 \text{ m}^2$
  - 2.  $401.43 \text{ m}^2$
  - 3.  $470.8 \text{ m}^2$
  - 4.  $481.43 \text{ m}^2$

Q.16 The length, breadth and height of a cuboid are in ratio of 3 : 4 : 5. If the volume of the cuboid is  $1620 \text{ m}^3$ , find the total surface area of the cuboid.

- Ans
- 1.  $646 \text{ m}^2$
  - 2.  $846 \text{ m}^2$
  - 3.  $423 \text{ m}^2$
  - 4.  $712 \text{ m}^2$

Q.17 The difference between 31% and 26% of votes for the same party at different places is 2350. What is 7% of those votes?

- Ans
- 1. 2270
  - 2. 3090
  - 3. 4090
  - 4. 3290

Q.18 Ravath had to sell vegetables worth ₹4,960 for ₹4,712 due to weather conditions. What is the loss percentage that he has incurred?

- Ans
- 1. 20%
  - 2. 10%
  - 3. 5%
  - 4. 15%

Q.19  $\triangle ABC$  is similar to  $\triangle DEF$  and the ratio of the area of triangle ABC to triangle DEF is 25 : 144. If  $AB = p$  cm,  $AC = q$  cm and  $BC = r$  cm, then  $DE = ?$

Ans

1.  $\frac{5}{12}q$

2.  $\frac{12}{5}q$

3.  $\frac{5}{12}p$

4.  $\frac{12}{5}p$

Q.20 A sum of ₹18,000 gives a simple interest of ₹3,240 in 2 years and 3 months. The rate of interest per annum is:

Ans

1. 10%

2. 12%

3. 8%

4. 7%

Q.21 Abhishek's marks in Mathematics were incorrectly entered as 93 instead of 63. Due to this, the average marks of the class in Mathematics got increased by 0.5. How many students were there in the class?

Ans

1. 45

2. 55

3. 60

4. 50

Q.22 AB is parallel to DC in a trapezium ABCD. It is given that  $AB > DC$  and the diagonals AC and BD intersect at O. If  $AO = 3x - 15$ ,  $OB = x + 9$ ,  $OC = x - 5$  and  $OD = 5$ , and  $x$  has two values  $x_1$  and  $x_2$ , then the value of  $(x_1^2 + x_2^2)$  is:

Ans

1. 45

2. 61

3. 73

4. 56

Q.23

The given chart represents the sales of automobiles in India (by type, in million units) from the year 2011 to 2014. Study the chart and answer the question that follows.

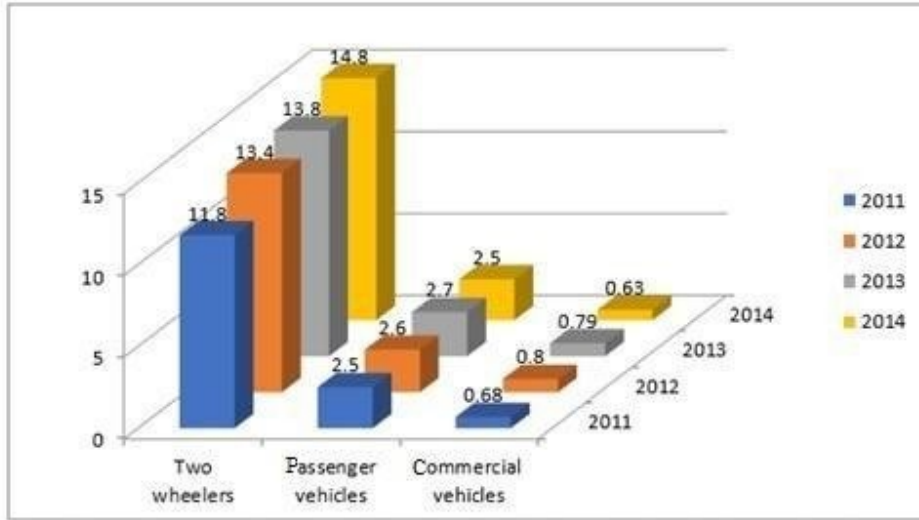

If the same percentage increase in the number of two wheelers as in 2014 over 2013 is expected in 2015, approximately how many two wheelers will be sold in 2015?

- Ans
- 1. 15.8 million
  - 2. 16.8 million
  - 3. 17.8 million
  - 4. 14.8 million

24. In triangle XYZ,  $XY = YZ$  and  $m\angle X = 78^\circ$ . Find the value of  $m\angle Y$ . Ans

- 1.  $78^\circ$
- 2.  $24^\circ$
- 3.  $34^\circ$
- 4.  $39^\circ$

25. If  $a : b = 3 : 4$ ,  $b : c = 2 : 3$ , and  $c : d = 5 : 6$ , then  $a : b : c : d$  is: Ans

- 1. 15 : 25 : 30 : 36
- 2. 15 : 20 : 30 : 36
- 3. 15 : 20 : 35 : 36
- 4. 10 : 20 : 30 : 36

Section : General Awareness

1. Brihadiswara Temple which exhibits Dravidian temple architecture is located in \_\_\_\_\_.

- Ans
- 1. Thanjavur
  - 2. Dharmapuri
  - 3. Madurai
  - 4. Thiruvananthapuram

2. In cricket, \_\_\_\_\_ is called by the umpire when the bowler doesn't deliver the ball within reach of the batter.

- Ans
- 1. wide
  - 2. dead ball
  - 3. no ball
  - 4. yorker

3. Which of the following rocky planets is the fastest planet in our solar system – traveling through space at about 29 miles (47 kilometres) per second?

- Ans
- 1. Earth
  - 2. Venus
  - 3. Mars
  - 4. Mercury

Q.4 Who among the following rulers was a part of the Tripartite Struggle for the possession of Kannauj?

- Ans
- 1. Dharmapala
  - 2. Yashovarman
  - 3. Mahendrapal
  - 4. Prithvi Raj III

Q.5 Bankim Chandra Chatterjee wrote a novel Anand Math based on which of the following rebellions/revolts?

- Ans
- 1. Mappila Rebellion
  - 2. Paika Rebellion
  - 3. Sanyasi Rebellion
  - 4. Kuki Revolt

Q.6 Which of the following statement(s) is/are INCORRECT vis-à-vis Fundamental Duties?

- 1) They are obligatory in nature
- 2) Fundamental Rights and Fundamental duties are complementary to each other.
- 3) The introduction of Article 51A created strong base for a concrete national character and strong harmony.
- 4) Eleventh fundamental duty was added by 78<sup>th</sup> constitutional amendment act.

- Ans
- 1. 1 and 2
  - 2. 2 and 3
  - 3. Only 3
  - 4. Only 4

Q.7 The phenomenon of the interaction between nonallelic genes at two or more loci resulting in one gene masking the phenotypic expression of another gene, is known as:

- Ans
- 1. linkage
  - 2. complete inheritance
  - 3. epistasis
  - 4. incomplete inheritance

Q.8 Sanjukta Panigrahi a legendary dancer is associated with which of the following dance forms?

- Ans
- 1. Bihu
  - 2. Laho
  - 3. Kuchipudi
  - 4. Odissi

Q.9 \_\_\_\_\_ was appointed British High Commissioner to India in April 2024.

- Ans
- 1. Nicholas Fenn
  - 2. Philip Barton
  - 3. Lindy Cameron
  - 4. Dominic Asquith

Q.10 Pinjore heritage festival is organised by the state of \_\_\_\_\_.

- Ans
- 1. Jharkhand
  - 2. Uttarakhand
  - 3. Sikkim
  - 4. Haryana

Q.11 In Microsoft Word, which option allows you to exclude specific sections or types of text from the spelling and grammar check?

- Ans
- 1. spell check
  - 2. AutoCorrect
  - 3. Exclusion Dictionary
  - 4. Thesaurus

Q.12 As per Census of India 2011, which of the following groups of states recorded the lowest literacy rate?

- Ans
- 1. Rajasthan and Assam
  - 2. Bihar and Arunachal Pradesh
  - 3. Rajasthan and Jharkhand
  - 4. Bihar and Madhya Pradesh

Q.13 The Maritime Anti-Piracy Act, 2022, was enacted to give effect to which of the following?

- Ans
- 1. United Nations Convention on the Law of the Sea relating to repression of piracy on high seas.
  - 2. United Nations Convention on Oceans and Seas relating to repression of piracy on high seas.
  - 3. United Nations Regional seas convention relating to repression of piracy on high seas.
  - 4. United Nations Treaty on Oceans relating to repression of piracy on high seas.

Q.14 With which of the following sports is Lovlina Borgohain associated?

- Ans
- 1. hockey
  - 2. cricket
  - 3. basketball
  - 4. boxing

Q.15 Which of the following states has mangrove forests?

- Ans
- 1. Telangana
  - 2. Andhra Pradesh
  - 3. Rajasthan
  - 4. Manipur

Q.16 Which state hosts the Nehru trophy boat race?

- Ans
- 1. Karnataka
  - 2. Tamil Nadu
  - 3. Kerala
  - 4. Goa

Q.17 Which of the following devices is used to accelerate charged particles to high velocities?

- Ans
- 1. cryotron
  - 2. copatron
  - 3. cosmotron
  - 4. cyclotron

Q.18 Which of the following options is INCORRECT?

- Ans
- 1. Distinguished economists from India and abroad were invited to advise on India's economic development during the first five-year plan period.
  - 2. India borrowed the idea of five-year plans from the former Soviet Union.
  - 3. The Planning Commission of India was set up in 1950.
  - 4. The chairmanship of the Planning Commission of India was given to the Prime Minister.

Q.19 In which of the following states are the Pai songs accompanied by the Saria dance sung during the rain festivals?

- Ans
- 1. Sikkim
  - 2. Uttar Pradesh
  - 3. Tripura
  - 4. Madhya Pradesh

Q.20 The relationship between which of the following is correct?

- Ans
- 1.  $NDP \text{ at market price} = GDP \text{ at market price} + \text{depreciation}$
  - 2.  $\text{Domestic income} = NDP \text{ at market price} + \text{net indirect taxes}$
  - 3.  $GDP \text{ at market price} = \text{price} + \text{quantity of final goods and services}$
  - 4.  $\text{National income} = NDP \text{ at factor cost} + \text{net factor income from abroad}$

Q.21 Match the states in column A to their ports in column B.

Column A (States)	Column B (Ports)
1. Goa	a. Mormugao Port
2. West Bengal	b. Kandla Port
3. Tamil Nadu	c. Tuticorin Port
4. Gujarat	d. Haldia Port

- Ans
- 1. 1-a, 2-d, 3-c, 4-b
  - 2. 1-a, 2-d, 3-b, 4-c
  - 3. 1-d, 2-a, 3-c, 4-b
  - 4. 1-a, 2-c, 3-d, 4-b

Q.22 The 42<sup>nd</sup> amendment of the Indian Constitution added \_\_\_\_\_.

- Ans
- 1. Legislature
  - 2. Fundamental rights
  - 3. Fundamental duties
  - 4. National anthem

Q.23 Who among the following is a singer of Hindustani classical music?

- Ans
- 1. Aruna Sairam
  - 2. Sudha Ragunathan
  - 3. S Sowmya
  - 4. Shubha Mudgal

Q.24 Which organisation, in collaboration with the Central Board of Secondary Education (CBSE), and the Ministry of Education, announced the launch of the 'AI For All' initiative with the purpose of creating a basic understanding of artificial intelligence for everyone in India?

- Ans
- 1. Intel
  - 2. Infosys
  - 3. TCS
  - 4. IBM

Q.25 Rows in MS-Excel are identified by:

Ans  1. letters

 2. numbers with letters

 3. numbers

 4. timings

Adda247 Marathi



## Combined Higher Secondary Level Examination 2024 Tier I

Exam Date	05/07/2024
Exam Time	11:45 AM - 12:45 PM
Subject	CHSL Exam 2024 Tier I

### Section : English Language

1. Select the option that corrects the following sentence.  
All tickets of the FIFA World Cup have been sold away.

Ans  1. All tickets of the FIFA World Cup have been sold into.  
 2. All tickets of the FIFA World Cup have been sold across.  
 3. All tickets of the FIFA World Cup have been sold out.  
 4. All tickets of the FIFA World Cup have been sold among.

2. The following sentence has been split into four segments. Identify the segment that contains a grammatical error. The soldiers / were selected / on the section / of 'gallantry of spirits'.

Ans  1. were selected  
 2. The soldiers  
 3. on the section  
 4. of 'gallantry of spirits'.

3. The following sentence has been split into four segments. Identify the segment that contains a grammatical error.

We has travelled / to many states / of India to get / an essence of its diversity.

Ans  1. to many states  
 2. of India to get  
 3. an essence of its diversity  
 4. We has travelled

- Q.4 Select the most appropriate option to fill in the blank.

The captain dropped the trophy while he \_\_\_\_\_ the victory with his teammates.

Ans  1. celebrated  
 2. celebrates  
 3. is celebrating  
 4. was celebrating

**Comprehension:**

In the following passage, some words have been deleted. Read the passage carefully and select the most appropriate option to fill in each blank.

For decades, humans have tried to theorise the origin and evolution of the universe. Many theories have been proposed and rejected. However, the Big Bang theory has been the most (1) \_\_\_\_\_accepted. According to this theory, the universe began as a single point, or singularity, around 13.8 billion years ago. This singularity contained all the matter and energy that would eventually (2)\_\_\_\_\_the stars, galaxies and other structures that make up our universe today. The Big Bang theory is supported by a (3)\_\_\_\_\_of observational evidence, including the cosmic microwave background radiation, the (4)\_\_\_\_\_of light elements in the universe and the large-scale structure of the cosmos. Despite its success, the Big Bang theory is still an active area of research, with scientists seeking to better understand the earliest moments of the universe and the (5)\_\_\_\_\_of dark matter and energy.

**SubQuestion No : 5**

**Q.5** Select the most appropriate option to fill in blank number 1.

- Ans**
- 1. widely
  - 2. vastly
  - 3. largely
  - 4. loosely

**Comprehension:**

In the following passage, some words have been deleted. Read the passage carefully and select the most appropriate option to fill in each blank.

For decades, humans have tried to theorise the origin and evolution of the universe. Many theories have been proposed and rejected. However, the Big Bang theory has been the most (1) \_\_\_\_\_accepted. According to this theory, the universe began as a single point, or singularity, around 13.8 billion years ago. This singularity contained all the matter and energy that would eventually (2)\_\_\_\_\_the stars, galaxies and other structures that make up our universe today. The Big Bang theory is supported by a (3)\_\_\_\_\_of observational evidence, including the cosmic microwave background radiation, the (4)\_\_\_\_\_of light elements in the universe and the large-scale structure of the cosmos. Despite its success, the Big Bang theory is still an active area of research, with scientists seeking to better understand the earliest moments of the universe and the (5)\_\_\_\_\_of dark matter and energy.

**SubQuestion No : 6**

**Q.6** Select the most appropriate option to fill in blank number 2.

- Ans**
- 1. form
  - 2. design
  - 3. prepare
  - 4. destroy

**Comprehension:**

In the following passage, some words have been deleted. Read the passage carefully and select the most appropriate option to fill in each blank.

For decades, humans have tried to theorise the origin and evolution of the universe. Many theories have been proposed and rejected. However, the Big Bang theory has been the most (1) \_\_\_\_\_accepted. According to this theory, the universe began as a single point, or singularity, around 13.8 billion years ago. This singularity contained all the matter and energy that would eventually (2)\_\_\_\_\_the stars, galaxies and other structures that make up our universe today. The Big Bang theory is supported by a (3)\_\_\_\_\_of observational evidence, including the cosmic microwave background radiation, the (4)\_\_\_\_\_of light elements in the universe and the large-scale structure of the cosmos. Despite its success, the Big Bang theory is still an active area of research, with scientists seeking to better understand the earliest moments of the universe and the (5)\_\_\_\_\_of dark matter and energy.

**SubQuestion No : 7**

**Q.7** Select the most appropriate option to fill in blank number 3.

- Ans**
- 1. rich
  - 2. wealth
  - 3. debt
  - 4. store

**Comprehension:**

In the following passage, some words have been deleted. Read the passage carefully and select the most appropriate option to fill in each blank.

For decades, humans have tried to theorise the origin and evolution of the universe. Many theories have been proposed and rejected. However, the Big Bang theory has been the most (1) \_\_\_\_\_accepted. According to this theory, the universe began as a single point, or singularity, around 13.8 billion years ago. This singularity contained all the matter and energy that would eventually (2)\_\_\_\_\_the stars, galaxies and other structures that make up our universe today. The Big Bang theory is supported by a (3)\_\_\_\_\_of observational evidence, including the cosmic microwave background radiation, the (4)\_\_\_\_\_of light elements in the universe and the large-scale structure of the cosmos. Despite its success, the Big Bang theory is still an active area of research, with scientists seeking to better understand the earliest moments of the universe and the (5)\_\_\_\_\_of dark matter and energy.

**SubQuestion No : 8**

**Q.8** Select the most appropriate option to fill in blank number 4.

- Ans**
- 1. abundance
  - 2. plenty
  - 3. fortune
  - 4. success

**Comprehension:**

In the following passage, some words have been deleted. Read the passage carefully and select the most appropriate option to fill in each blank.

For decades, humans have tried to theorise the origin and evolution of the universe. Many theories have been proposed and rejected. However, the Big Bang theory has been the most (1) \_\_\_\_\_accepted. According to this theory, the universe began as a single point, or singularity, around 13.8 billion years ago. This singularity contained all the matter and energy that would eventually (2)\_\_\_\_\_the stars, galaxies and other structures that make up our universe today. The Big Bang theory is supported by a (3)\_\_\_\_\_of observational evidence, including the cosmic microwave background radiation, the (4)\_\_\_\_\_of light elements in the universe and the large-scale structure of the cosmos. Despite its success, the Big Bang theory is still an active area of research, with scientists seeking to better understand the earliest moments of the universe and the (5)\_\_\_\_\_of dark matter and energy.

**SubQuestion No : 9**

**Q.9** Select the most appropriate option to fill in blank number 5.

- Ans**
- 1. nature
  - 2. environment
  - 3. capture
  - 4. brand

**Q.10** Select the most appropriate option that can substitute the underlined word segment in the following sentence.

The girl which is wearing a blue shirt is my sister.

- Ans**
- 1. which is wearing the blue shirt
  - 2. who is wearing a blue shirt
  - 3. which wear a blue shirt
  - 4. who wear a blue shirt

**Q.11** Select the most appropriate meaning of the underlined idiom.

The United Nations is working to eliminate the vicious cycle of poverty.

- Ans**
- 1. The barrier of poverty
  - 2. One problem causes other
  - 3. Loophole of something
  - 4. Strength of something

**Q.12** Select the INCORRECTLY spelt word.

- Ans**
- 1. Innoculate
  - 2. Irreverent
  - 3. Immense
  - 4. Immaculate

Q.13 Identify the most appropriate ANTONYM of the underlined word in the given sentence.  
The vendor said that the apples were of superior quality.

- Ans
- 1. Excellent
  - 2. Distasteful
  - 3. Small
  - 4. Inferior

Q.14 Select the most appropriate synonym of the given word.  
Permit

- Ans
- 1. Disgrace
  - 2. Flout
  - 3. Approve
  - 4. Abandon

Q.15 Select the most appropriate meaning of the given idiom.

Bag and baggage

- Ans
- 1. At the service
  - 2. By force
  - 3. With all goods
  - 4. Fair and honest

Q.16 Select the most appropriate homophone to fill in the blank.  
Arun knows perfectly well how to mix the food items with \_\_\_\_\_.

- Ans
- 1. sauce
  - 2. saws
  - 3. sause
  - 4. source

Q.17 Select the most appropriate ANTONYM of the underlined word.  
No one trusts her as her reasons are always explicit.

- Ans
- 1. Precise
  - 2. Ambiguous
  - 3. Exact
  - 4. Distant

Q.18 Read the sentence carefully and select the most appropriate option to substitute the underlined part.

The clamour distracted the priest and made him angry.

- Ans
- 1. loud and confused noise
  - 2. narrow-mindedness
  - 3. introduction of new things
  - 4. humorous deception

Q.19 Select the most appropriate ANTONYM of the underlined word in the given sentence.  
Essays must be concise.

- Ans
- 1. Excise
  - 2. Lengthy
  - 3. Precise
  - 4. Total

Q.20 Select the most appropriate option to fill in the blank.

Which \_\_\_\_\_ do you usually take to reach your office?

- Ans
- 1. rude
  - 2. route
  - 3. root
  - 4. rout

Q.21 Select the correct collocation to complete the following sentence.

He made \_\_\_\_\_ use of the opportunity to travel.

- Ans
- 1. full
  - 2. total
  - 3. entire
  - 4. whole

Q.22 The following sentence has been split into four segments. Identify the segment that contains a spelling error.  
The make-up room was filled / with incadescent lights / which added to the misery / of those subjected to make-up.

- Ans
- 1. which added to the misery
  - 2. with incadescent lights
  - 3. of those subjected to make-up
  - 4. The make-up room was filled

Q.23 Select the most appropriate synonym of the given word.  
Tedious

- Ans
- 1. Exciting
  - 2. Boring
  - 3. Working
  - 4. Happening

Q.24 Select the most appropriate option that can substitute the underlined segment in the given sentence.  
Employers in many developing countries report that a lack of skilled workers is a major and increasing bottleneck for their operations, affected their capacity to innovate.

- Ans
- 1. affect their capacity
  - 2. effecting their capacity
  - 3. effect their capacity
  - 4. affecting their capacity

Q.25 Select the most appropriate option that can substitute the underlined word in the given sentence.  
The dedicated teacher laboured assiduously to aid her pupils in achieving success.

- Ans
- 1. un-biased
  - 2. committed
  - 3. uninvolved
  - 4. apathetic

Section : General Intelligence

Q.1 TMBF is related to ATIM in a certain way based on the English alphabetical order. In the same way, CLGP is related to JSNW. To which of the following is QEAD related, following the same logic?

- Ans
- 1. XKHL
  - 2. XLKH
  - 3. XLHK
  - 4. XHKL

Q.2 What should come in place of ? in the given series based on the English alphabetical order?

TUV RXR ? NDJ LGF

- Ans
- 1. PAN
  - 2. VOI
  - 3. NAP
  - 4. CAL

Q.3 Which figure should replace the question mark (?) if the following figure series were to be continued?

Q	□	3	I	5	△	△	I	5	Q	9	3	
	△		Q				3		△			?
I	5	G	G	□	3	Q	9	G	G	I	5	

Ans

1.

3	Q	9
	E	
5	G	I

2.

3	Q	9
	I	
5	△	G

3.

3	Q	9
	5	
△	E	G

4.

3	Q	9
	5	
△	G	E

Q.4 Select the correct option that when filled in the blanks in the same sequence will make the series logically complete.  
GH\_ST\_HO\_RGHOSPG\_OS\_

- Ans
- 1. GORNH
  - 2. ORHSN
  - 3. OGSNH
  - 4. GOHNP

Q.5 12 is related to 72 following a certain logic. Following the same logic, 19 is related to 114. To which of the following is 29 related following the same logic?  
(NOTE : Operations should be performed on the whole numbers, without breaking down the numbers into its constituent digits. E.g. 13 – Operations on 13 such as adding /deleting /multiplying etc., to 13 can be performed. Breaking down 13 into 1 and 3 and then performing mathematical operations on 1 and 3 is not allowed.)

- Ans
- 1. 171
  - 2. 174
  - 3. 170
  - 4. 173

Q.6 If 19 July 2012 is Thursday, then what will be the day of the week on 11 January 2018?

- Ans
- 1. Monday
  - 2. Saturday
  - 3. Thursday
  - 4. Wednesday

Q.7 Four letter-clusters have been given, out of which three are alike in some manner and one is different. Select the one that is different.  
(Note: The odd one out is not based on the number of consonants/vowels or their position in the letter cluster.)

- Ans
- 1. OMJ
  - 2. PNK
  - 3. RTQ
  - 4. BZW

Q.8 The position of how many letters will remain unchanged if all the letters in the word DIALECT are arranged in alphabetical order?

- Ans
- 1. Two
  - 2. Four
  - 3. One
  - 4. Three

Q.9 What should come in place of the question mark (?) in the given series?

63, 64, 66, 69, 73, ?

- Ans
- 1. 78
  - 2. 80
  - 3. 79
  - 4. 77

Q.10 In a certain code language,

$A + B$  means 'A is the daughter of B'

$A - B$  means 'A is the wife of B'

$A \times B$  means 'A is the brother of B'

$A \div B$  means 'A is the father of B'.

Based on the above, if ' $P + Q \times R - S \div T$ ', which of the following is true?

- Ans
- 1. T is S's Son.
  - 2. Q is the brother of S.
  - 3. P is the sister of T.
  - 4. P is the daughter of T's Mother's Brother.

Q.11 Select the correct mirror image of the given combination when the mirror is placed at MN as shown below.

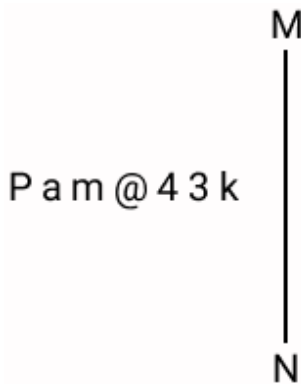

- Ans
- 1. P a m @ 4 3 k
  - 2. P a m @ 4 3 k
  - 3. P a m @ 4 3 k
  - 4. P a m @ 4 3 k

Q.12 Which of the following numbers will replace the question mark (?) in the given series?

11 4 22 20 44 100 88 500 ?

- Ans
- 1. 176
  - 2. 182
  - 3. 160
  - 4. 154



**Q.13** A square sheet of paper is folded along the dotted line successively along the directions shown and is then punched in the last. How would the paper look when unfolded?

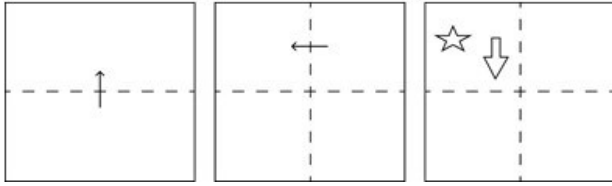

**Ans**

1.

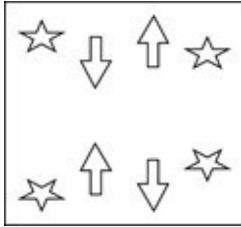

2.

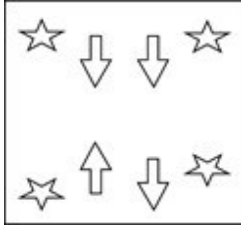

3.

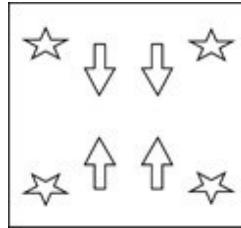

4.

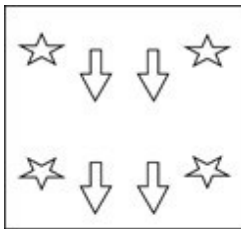

**Q.14** What will come in place of '?' in the following equation, if '+' and '-' are interchanged and '×' and '÷' are interchanged?

$$15 + 2 - 13 \times 13 \div 3 = ?$$

**Ans**  1. 23

2. 24

3. 18

4. 16

**Q.15** If 'A' stands for '+', 'B' stands for '×', 'C' stands for '÷' and 'D' stands for '-', what will come in place of the question mark (?) in the following equation?

$$17 \ C \ 69 \ A \ 3 \ D \ 22 \ B \ 1 = ?$$

**Ans**  1. 18

2. 16

3. 12

4. 14

Q.16 How many triangles are there in the given figure?

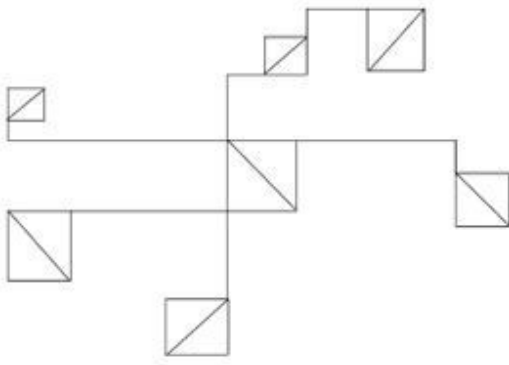

- Ans
- 1. 15
  - 2. 13
  - 3. 14
  - 4. 12

Q.17 Select the option in which the given figure is embedded. (Rotation is NOT allowed.)

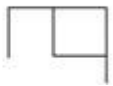

- Ans
- 1.
  - 2.
  - 3.
  - 4.

Q.18 In a certain code language, 'SOAP' is coded as '4629' and 'SPOT' is coded as '9824'. How is 'A' coded in the given language?

- Ans
- 1. 4
  - 2. 2
  - 3. 8
  - 4. 6

Q.19 Select the set in which the numbers are related in the same way as are the numbers of the following sets.

(13, 234, 9)  
(15, 180, 6)

(NOTE : Operations should be performed on the whole numbers, without breaking down the numbers into its constituent digits. E.g. 13 – Operations on 13 such as adding /subtracting /multiplying etc., to 13 can be performed. Breaking down 13 into 1 and 3 and then performing mathematical operations on 1 and 3 is not allowed.)

- Ans
- 1. (17, 340, 5)
  - 2. (16, 240, 5)
  - 3. (14, 196, 7)
  - 4. (12, 10)

Q.20

What would be the number on the opposite side of '8' if the given sheet is folded to form a cube?

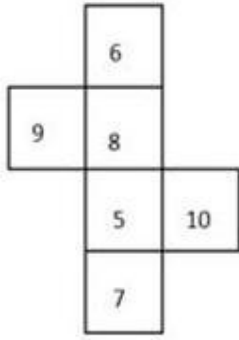

- Ans
- 1. 7
  - 2. 6
  - 3. 10
  - 4. 5

Q.21

Select the correct mirror image of the given figure when the mirror is placed at MN as shown below.

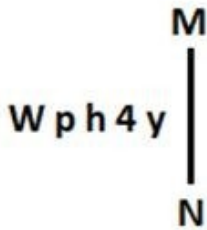

- Ans
- 1. y Ꞥ h q W
  - 2. ʌ Ꞥ h q W
  - 3. y Ꞥ h q W
  - 4. y p h 4 W

Q.22 Three statements are followed by conclusions numbered I, II. You have to consider these statements to be true, even if they seem to be at variance with commonly known facts. Decide which of the given conclusions logically follow/s from the given statement.

Statements:

All jams are butter.

Some nibs are ink.

Some nibs are butter.

Conclusion (I): Some ink is butter.

Conclusion (II): All jams are nibs.

- Ans
- 1. Only conclusion (II) follows.
  - 2. Only conclusion (I) follows.
  - 3. Neither conclusion (I) nor (II) follows.
  - 4. Both conclusions (I) and (II) follow.

Q.23 What will come in the place of '?' in the following equation if '+' and 'x' are interchanged and '-' and '÷' are interchanged?  
 $21 - 7 \times 26 + 46 \div 36 = ?$

- Ans
- 1. 1163
  - 2. 8667
  - 3. 760
  - 4. 908

Q.24 In a certain code language, 'pleased to meet' is written as 'bj sc vw' and 'meet and greet' is written as 'ih bj tf'. How is 'meet' written in the given language?

- Ans
- 1. vw
  - 2. tf
  - 3. bj
  - 4. ih

Q.25 RTVX is related to SUWY in a certain way based on the English alphabetical order. In the same way, KMOQ is related to LNPR. To which of the following is FHJL related, following the same logic?

- Ans
- 1. GIKM
  - 2. GHJK
  - 3. GIJK
  - 4. GIKN

Section : Quantitative Aptitude

Q.1 To reach at a destination, D takes 45 minutes if he drives at a speed of 60 km/h. Due to some urgency, he is to reach the destination in 30 minutes. What should be his speed in km/h?

- Ans
- 1. 90
  - 2. 60
  - 3. 80
  - 4. 75

Q.2 Study the given graph and answer the question that follows.

The graph shows the exports from three companies (A, B and C) over the years (in ₹ crore).

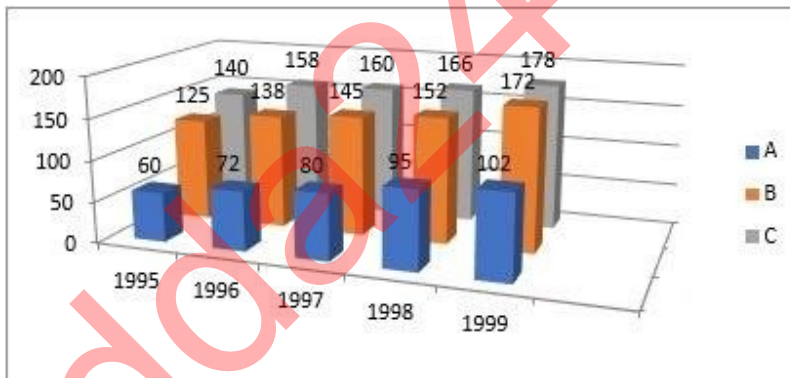

In how many given years, were the exports from company C less than the average annual exports over the given years?

- Ans
- 1. 5
  - 2. 3
  - 3. 2
  - 4. 4

Q.3 If  $\frac{1}{M} : \frac{1}{N} : \frac{1}{O} = 3 : 4 : 5$ , then M : N : O is equal to:

- Ans
- 1. 12 : 15 : 20
  - 2. 15 : 20 : 12
  - 3. 20 : 12 : 15
  - 4. 20 : 15 : 12

Q.4 Study the given pie chart and answer the question that follows.

The pie chart shows the marks obtained by a student in an examination. The total marks he scored is 450.

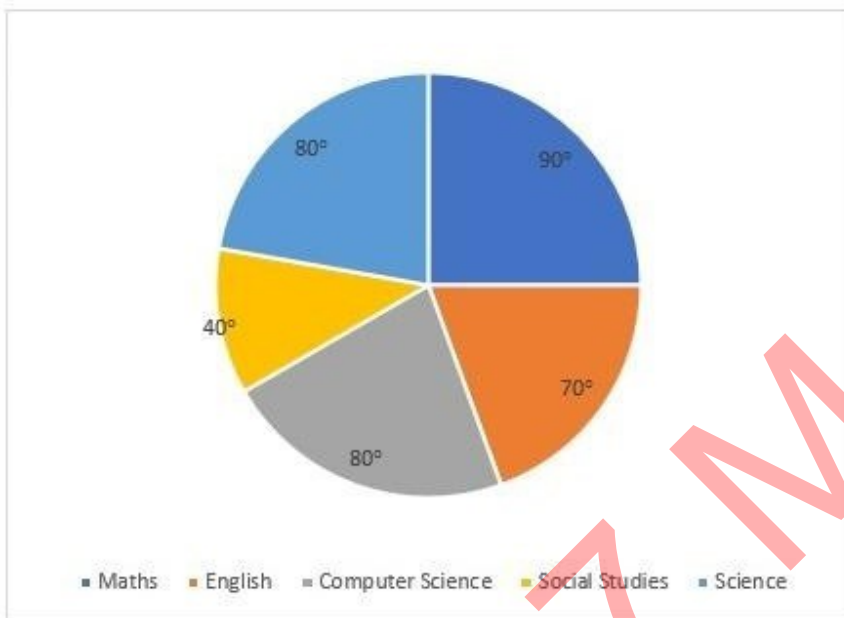

The difference between the marks obtained in (English+Maths) and (Computer Science+Science) is:

- Ans
- 1. 10
  - 2. 30
  - 3. 0
  - 4. 20

Q.5 An equal sum of money was lent to P and Q at 8.6% per annum for a period of 7 years and 8 years, respectively. If the difference in interest paid by them was ₹172, then the sum lent to each was:

- Ans
- 1. ₹3,000
  - 2. ₹2,150
  - 3. ₹185
  - 4. ₹2,000

Q.6 A chord of length 12 units in a circle of radius 10 units is \_\_\_\_\_ units away from its centre.

- Ans
- 1. 8
  - 2. 9
  - 3. 10
  - 4. 6

Q.7 The given table shows the number of pizzas sold by four different bakeries in 5 different months.

Bakery / Month	October	November	December	January	February
X	102	120	105	130	140
Y	98	104	115	120	136
Z	89	106	112	118	126
W	96	105	97	110	122

What is the respective ratio of the total number of pizzas sold by bakeries Y and Z together in November to the total number of pizzas sold by bakeries X and W together in the same month?

- Ans
- 1. 34 : 37
  - 2. 42 : 45
  - 3. 32 : 45
  - 4. 42 : 49

Q.8 Raju spends 80% of his income. His income increased by 20%, while his spending rise by 10%. The percentage of increase in his savings is:

- Ans
- 1. 48%
  - 2. 40%
  - 3. 60%
  - 4. 30%

Q.9 The sum of two-digit number and the number obtained by interchanging the digit is 77. If the difference of digits is 1, then the number is:

- Ans
- 1. 67
  - 2. 45
  - 3. 34
  - 4. 12

Q.10 A shopkeeper marks up his goods 32% above the cost price and gives a discount of 21% on the marked price. Find his gain percentage on the goods.

- Ans
- 1. 4.82%
  - 2. 8.42%
  - 3. 8.24%
  - 4. 4.28%

Q.11 Find the height of the triangle whose base is two-thirds of its height and whose area is  $363 \text{ cm}^2$

- Ans
- 1. 31 cm
  - 2. 33 cm
  - 3. 29 cm
  - 4. 27 cm

Q.12 A solid copper sphere of radius 9 cm is drawn into a wire of radius 4 mm. Find the length of the wire.

- Ans
- 1. 60.75 m
  - 2. 70.25 m
  - 3. 65.25 m
  - 4. 20.75 m

Q.13 The radii of two concentric circles are 35 cm and 21 cm. If the chord of the greater circle is a tangent to the smaller circle, then the length of that chord is:

- Ans
- 1. 70 cm
  - 2. 42 cm
  - 3. 56 cm
  - 4. 28 cm

Q.14 Shobhita can complete a painting work in 20 hours while Saroj can complete the same work in 15 hours. In how much time (in hours) can the entire work of painting be completed, if both Shobhita and Saroj work simultaneously?

- Ans
- 1. 7
  - 2.  $8\frac{4}{7}$
  - 3.  $7\frac{4}{7}$
  - 4. 8

Q.15 If  $\sin(X - Y) = \sin X \cos Y - \cos X \sin Y$ , then the value of  $\frac{\sin(A-B)}{\cos A \cos B} + \frac{\sin(B-C)}{\cos B \cos C}$  is:

- Ans
- 1.  $\frac{\sin(C - A)}{\cos A \cos C}$
  - 2.  $\frac{\sin(A - C)}{\cos A \cos C}$
  - 3.  $\frac{\cos(A + C)}{\cos A \cos C}$
  - 4.  $\frac{\cos(A + C)}{\sin A \sin C}$

Q.16 The diameter of the base of a cylindrical tank is 28 cm and its height is 42 cm. Find its curved surface area.

- Ans
- 1.  $3680 \text{ cm}^2$
  - 2.  $3690 \text{ cm}^2$
  - 3.  $3696 \text{ cm}^2$
  - 4.  $3686 \text{ cm}^2$

Q.17 Write the smallest digit in the blank space of a number 7\_\_7624, so that the number formed is divisible by 3.

- Ans
- 1. 1
  - 2. 2
  - 3. 0
  - 4. 3

Q.18 A number is first increased by 44% and then decreased by 30%. The net percentage change (rounded off to the nearest integer) in the original number is:

- Ans
- 1. increase by 1%
  - 2. decrease by 4%
  - 3. increase by 4%
  - 4. decrease by 1%

Q.19 The given graph shows the higher secondary result of a particular school, from 2019 to 2021. Study the graph and answer the question that follows.

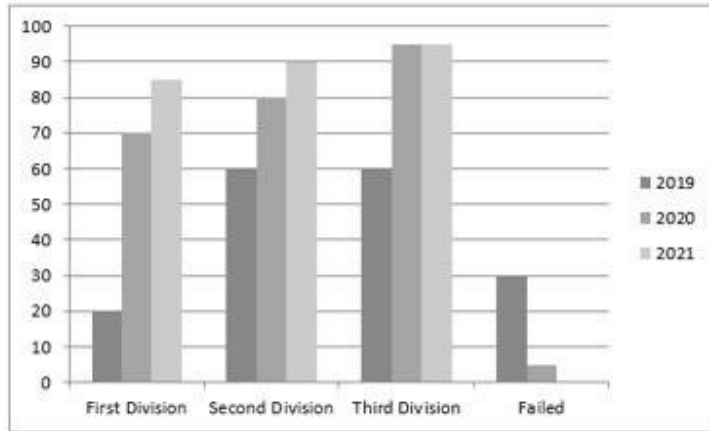

The percentage of students who passed in the year 2020 is:

- Ans
- 1. 98%
  - 2. 28%
  - 3. 30%
  - 4. 70%

Q.20 Simplify

$$\frac{\frac{1}{2} \div \frac{3}{4} \text{ of } \frac{5}{6}}{\frac{1}{2} \div \frac{3}{4} \times \frac{5}{6}} + \frac{2 + 2 \times 2}{2 \div 2 \times 2}$$

- Ans
- 1.  $\frac{121}{25}$
  - 2. 4
  - 3.  $\frac{111}{25}$
  - 4.  $\frac{75}{36}$

Q.21 PQ is a chord of a circle. The tangent XR at point X on the circle intersects the extension of PQ at point R. Given that XR = 12 cm, PQ = x cm, and QR = (x - 2) cm, find the value of x.

- Ans
- 1. 11 cm
  - 2. 9 cm
  - 3. 8 cm
  - 4. 10 cm



Q.22 Ramendra purchased some watermelons for ₹1,500. He sold one-fourth of them at a loss of 12%. At what gain percentage should the remaining watermelons be sold so as to gain 25% on the whole transaction (correct to two decimal places)?

- Ans
- 1. 37.33%
  - 2. 33.73%
  - 3. 37.65%
  - 4. 33.43%

Q.23  $\triangle ABC$  and  $\triangle DEF$  are similar and their areas are respectively  $0.64 \text{ m}^2$  and  $0.0121 \text{ m}^2$ . If  $EF = 0.154 \text{ m}$ , then  $BC$  is:

- Ans
- 1. 1.15 m
  - 2. 11.2 m
  - 3. 1.12 m
  - 4. 2.12 m

Q.24 In an election between two candidates, one candidate gets 72% of the total votes cast. If the total votes are 1000, by how many votes does the winner win the election?

- Ans
- 1. 360
  - 2. 250
  - 3. 720
  - 4. 440

Q.25 The average age of 24 workers and their supervisor is 41 years. If the supervisor's age is excluded, the average reduces by 0.75 years. The age of the supervisor is:

- Ans
- 1. 59 years
  - 2. 41 years 9 months
  - 3. 40 years 9 months
  - 4. 49 years

Section : General Awareness

1. Who is the author of the Indian national anthem?

- Ans
- 1. Bankim Chandra Chattopadhyay
  - 2. Ishwar Chandra Vidyasagar
  - 3. Kazi Nazrul Islam
  - 4. Rabindranath Tagore

2. Which MS Excel function can be used to sum up the numbers entered in a group of cells?

- Ans
- 1. COUNT
  - 2. AVERAGE
  - 3. MAX
  - 4. SUM

3. Which of the Mendel's laws states that a diploid organism passes a randomly selected allele for a trait to its offspring, such that the offspring inherit one allele from each parent?

- Ans
- 1. Law of dominance
  - 2. Law of paired factor
  - 3. Law of independent assortment
  - 4. Law of segregation

Q.4 In 2026, which country will host Asian Games?

- Ans
- 1. India
  - 2. China
  - 3. Japan
  - 4. Nepal

Q.5 Which directive principle has been implemented in establishing Handloom and Handicrafts Boards?

- Ans
- 1. Promote cottage industries on cooperative basis
  - 2. Provision for just and humane condition of work
  - 3. Participation of workers in management of Industries
  - 4. Protection and improvement of environment

Q.6 Give Plastic and Take Gold scheme was launched in the village of which State/UT in year 2023?

- Ans
- 1. Gujarat
  - 2. Lakshadweep
  - 3. Jammu and Kashmir
  - 4. Assam

Q.7 Marathi language is in the \_\_\_\_\_ language family.

- Ans
- 1. Austro
  - 2. Sino-India
  - 3. Austric
  - 4. Indo Aryan

Q.8 The music of traditional \_\_\_\_\_ consists of thumri and other lyrical song forms.

- Ans
- 1. Kuchipudi
  - 2. Kathak
  - 3. Kathakali
  - 4. Sattriya

Q.9 Gandhi Jayanti marks the birthday of the father of the nation Mahatma Gandhi, who was born at \_\_\_\_\_.

- Ans
- 1. Ahmedabad
  - 2. Vadodara
  - 3. Porbandar
  - 4. Gandhinagar

Q.10 Ohira folk music is primarily associated with one of the popular festivals of which of the following states?

- Ans
- 1. Kerala
  - 2. Assam
  - 3. Jharkhand
  - 4. Karnataka

Q.11 Which of the following planets' atmosphere is made up of thick white and yellowish clouds of sulphuric acid? Ans

- 1. Venus
- 2. Neptune
- 3. Mars
- 4. Jupiter

Q.12 Which of the following is a public sector owned and operated entity?

- Ans
- 1. Bajaj Auto Ltd
  - 2. Oil India Ltd.
  - 3. BHEL
  - 4. Tata Steel Ltd

Q.13 According to Census of India 2011, which district in India has the lowest literacy rate in India?

- Ans
- 1. Rampur
  - 2. Madhubani
  - 3. Alirajpur
  - 4. Aizwal

Q.14 The Tokyo Paralympics 2020 gold medal winner Krishna Nagar is associated with \_\_\_\_\_.

- Ans
- 1. shooting
  - 2. wrestling
  - 3. table tennis
  - 4. badminton

Q.15 Which is the Standard Meridian of India?

- Ans
- 1. 84°40' E
  - 2. 82°30' E
  - 3. 81°30' E
  - 4. 83°30' E

Q.16 Who is Chairman of the Union Public Service Commission as on 31 March 2024?

- Ans
- 1. Mrs. Preeti Sudan
  - 2. Shri Manoj Soni
  - 3. Shri BN Jha
  - 4. Ms. Smita Nagaraj

Q.17 The process of merging data from a data source into a main document in a word-processing application is called:

- Ans
- 1. data concatenation
  - 2. mail merge
  - 3. data accumulation
  - 4. data integration

Q.18 In 1960, which isotope was used to define the standard measure of length?

- Ans
- 1. Krypton-86
  - 2. Krypton-88
  - 3. Krypton-83
  - 4. Krypton-90

Q.19 Who is the Union Minister of Civil Aviation in Government of India? (As of March, 2024).

- Ans
- 1. G Kishan Reddy
  - 2. Kiren Rijju
  - 3. Raj Kumar Singh
  - 4. Jyotiraditya M. Scindia

**Q.20** Which of the following is NOT a feature of a monopoly?

- Ans**
- 1. No close substitutes
  - 2. Full control over the price by the seller
  - 3. One buyer and many sellers
  - 4. One seller and many buyers

**Q.21** There is a cable manufacturing facility at HCL in Rupnarainpur. It is belong to which state?

- Ans**
- 1. Assam
  - 2. Haryana
  - 3. Andhra Pradesh
  - 4. West Bengal

**Q.22** Due to the efforts of whom among the following social reformers was the first Hindu Widow Remarriage Act introduced and passed in 1856?

- Ans**
- 1. Radhakant Deb
  - 2. Atmaram Pandurang
  - 3. Ishwar Chandra Vidyasagar
  - 4. Raja Ram Mohan Roy

**Q.23** Who among the following was the first Sultan of Delhi to style himself as 'Zil-i-llahi'?

- Ans**
- 1. Qutbuddin Aibak
  - 2. Feroz Shah
  - 3. Balban
  - 4. Iltutmish

**Q.24** The Constitution of India was adopted on \_\_\_\_\_.

- Ans**
- 1. 26 November 1949
  - 2. 24 November 1947
  - 3. 26 January 1949
  - 4. 26 January 1950

**Q.25** Who was the first Indian wrestler to win Gold at the World Championships in 2010?

- Ans**
- 1. Alka Tomar
  - 2. Sushil Kumar
  - 3. Bajrang Punia
  - 4. Geeta Phogat

## Combined Higher Secondary Level Examination 2024 Tier I

Exam Date	05/07/2024
Exam Time	2:30 PM - 3:30 PM
Subject	CHSL Exam 2024 Tier I

### Section : English Language

1. The following sentence has been split into four segments. Identify the segment that contains a grammatical error. With hard work, commitment / and proper guidance, / Sivaram has become / a IPS officer.

- Ans
- 1. With hard work, commitment
  - 2. and proper guidance,
  - 3. a IPS officer
  - 4. Sivaram has become

2. Parts of the following sentence have been given as options. Select the option that contains an error. A owl is a bird which has wide eyes, asymmetrical ears and is found mostly in forests.

- Ans
- 1. and is found mostly in forests.
  - 2. asymmetrical ears
  - 3. A owl is a bird
  - 4. which has wide eyes,

3. The following sentence has been split into four segments. Identify the segment that contains a grammatical error. The teacher will never / give you punishment / if you will / come on time.

- Ans
- 1. give you punishment
  - 2. if you will
  - 3. come on time
  - 4. the teacher will never

Q.4 The following sentence has been split into four segments. Identify the segment that contains an error. If she exercises daily, / she would / remain energetic / and fit forever.

- Ans
- 1. remain energetic
  - 2. If she exercises daily
  - 3. and fit forever
  - 4. she would

**Comprehension:**

In the following passage, some words have been deleted. Read the passage carefully and select the most appropriate option to fill in each blank.

Romantic poetry is a literary movement that emerged in the late 18th century and continued through the mid-19th century. It is (1)\_\_\_\_\_by an emphasis on emotion, imagination and individualism. Romantic poets sought to express their innermost thoughts and feelings through their poetry, often exploring (2)\_\_\_\_\_such as love, beauty and mortality. One of the defining features of Romantic poetry is its use of language and imagery to evoke powerful emotions in the reader. Many Romantic poets, such as William Wordsworth and Samuel Taylor Coleridge (3)\_\_\_\_\_that poetry should be written in the language of common people, rather than in the lofty, formal language of the past. They also incorporated vivid descriptions of nature and the natural world into their poetry, using it as a source of inspiration and spiritual renewal. (4)\_\_\_\_\_important aspect of Romantic poetry is its focus on the individual and the subjective experience. Romantic poets believed that each persons experience of the world was unique and valuable, and sought to capture this individuality in their writing. This led to a greater emphasis on personal expression and introspection in poetry, (5)\_\_\_\_\_a rejection of the traditional poetic forms and structures of the past.

**SubQuestion No : 5**

**Q.5** Select the most appropriate option to fill in blank number 1.

- Ans**
- 1. characterises
  - 2. characteristic
  - 3. characterised
  - 4. characterising

**Comprehension:**

In the following passage, some words have been deleted. Read the passage carefully and select the most appropriate option to fill in each blank.

Romantic poetry is a literary movement that emerged in the late 18th century and continued through the mid-19th century. It is (1)\_\_\_\_\_by an emphasis on emotion, imagination and individualism. Romantic poets sought to express their innermost thoughts and feelings through their poetry, often exploring (2)\_\_\_\_\_such as love, beauty and mortality. One of the defining features of Romantic poetry is its use of language and imagery to evoke powerful emotions in the reader. Many Romantic poets, such as William Wordsworth and Samuel Taylor Coleridge (3)\_\_\_\_\_that poetry should be written in the language of common people, rather than in the lofty, formal language of the past. They also incorporated vivid descriptions of nature and the natural world into their poetry, using it as a source of inspiration and spiritual renewal. (4)\_\_\_\_\_important aspect of Romantic poetry is its focus on the individual and the subjective experience. Romantic poets believed that each persons experience of the world was unique and valuable, and sought to capture this individuality in their writing. This led to a greater emphasis on personal expression and introspection in poetry, (5)\_\_\_\_\_a rejection of the traditional poetic forms and structures of the past.

**SubQuestion No : 6**

**Q.6** Select the most appropriate option to fill in blank number 2.

- Ans**
- 1. concerns
  - 2. arguments
  - 3. problems
  - 4. themes

**Comprehension:**

In the following passage, some words have been deleted. Read the passage carefully and select the most appropriate option to fill in each blank.

Romantic poetry is a literary movement that emerged in the late 18th century and continued through the mid-19th century. It is (1)\_\_\_\_\_by an emphasis on emotion, imagination and individualism. Romantic poets sought to express their innermost thoughts and feelings through their poetry, often exploring (2)\_\_\_\_\_such as love, beauty and mortality. One of the defining features of Romantic poetry is its use of language and imagery to evoke powerful emotions in the reader. Many Romantic poets, such as William Wordsworth and Samuel Taylor Coleridge (3)\_\_\_\_\_that poetry should be written in the language of common people, rather than in the lofty, formal language of the past. They also incorporated vivid descriptions of nature and the natural world into their poetry, using it as a source of inspiration and spiritual renewal. (4)\_\_\_\_\_important aspects of Romantic poetry is its focus on the individual and the subjective experience. Romantic poets believed that each persons experience of the world was unique and valuable, and sought to capture this individuality in their writing. This led to a greater emphasis on personal expression and introspection in poetry, (5)\_\_\_\_\_a rejection of the traditional poetic forms and structures of the past.

**SubQuestion No : 7**

**Q.7** Select the most appropriate option to fill in blank number 3.

- Ans**
- 1. could believe
  - 2. will believe
  - 3. believes
  - 4. believed

**Comprehension:**

In the following passage, some words have been deleted. Read the passage carefully and select the most appropriate option to fill in each blank.

Romantic poetry is a literary movement that emerged in the late 18th century and continued through the mid-19th century. It is (1)\_\_\_\_\_ by an emphasis on emotion, imagination and individualism. Romantic poets sought to express their innermost thoughts and feelings through their poetry, often exploring (2)\_\_\_\_\_ such as love, beauty and mortality. One of the defining features of Romantic poetry is its use of language and imagery to evoke powerful emotions in the reader. Many Romantic poets, such as William Wordsworth and Samuel Taylor Coleridge (3)\_\_\_\_\_ that poetry should be written in the language of common people, rather than in the lofty, formal language of the past. They also incorporated vivid descriptions of nature and the natural world into their poetry, using it as a source of inspiration and spiritual renewal. (4)\_\_\_\_\_ important aspect of Romantic poetry is its focus on the individual and the subjective experience. Romantic poets believed that each persons experience of the world was unique and valuable, and sought to capture this individuality in their writing. This led to a greater emphasis on personal expression and introspection in poetry, (5)\_\_\_\_\_ a rejection of the traditional poetic forms and structures of the past.

**SubQuestion No : 8**

**Q.8** Select the most appropriate option to fill in blank number 4.

- Ans**
- 1. Mostly
  - 2. Additional
  - 3. Another
  - 4. Farther

**Comprehension:**

In the following passage, some words have been deleted. Read the passage carefully and select the most appropriate option to fill in each blank.

Romantic poetry is a literary movement that emerged in the late 18th century and continued through the mid-19th century. It is (1)\_\_\_\_\_ by an emphasis on emotion, imagination and individualism. Romantic poets sought to express their innermost thoughts and feelings through their poetry, often exploring (2)\_\_\_\_\_ such as love, beauty and mortality. One of the defining features of Romantic poetry is its use of language and imagery to evoke powerful emotions in the reader. Many Romantic poets, such as William Wordsworth and Samuel Taylor Coleridge (3)\_\_\_\_\_ that poetry should be written in the language of common people, rather than in the lofty, formal language of the past. They also incorporated vivid descriptions of nature and the natural world into their poetry, using it as a source of inspiration and spiritual renewal. (4)\_\_\_\_\_ important aspect of Romantic poetry is its focus on the individual and the subjective experience. Romantic poets believed that each persons experience of the world was unique and valuable, and sought to capture this individuality in their writing. This led to a greater emphasis on personal expression and introspection in poetry, (5)\_\_\_\_\_ a rejection of the traditional poetic forms and structures of the past.

**SubQuestion No : 9**

**Q.9** Select the most appropriate option to fill in blank number 5.

- Ans**
- 1. whereas
  - 2. therefore
  - 3. as well as
  - 4. but

**Q.10** Select the most appropriate ANTONYM for the underlined word in the given sentence.

As a punishment for his betrayal to his country, the spy who sold secrets was sent to prison.

- Ans**
- 1. Infidelity
  - 2. Loyalty
  - 3. Perilous
  - 4. Nasty

**Q.11** Select the most appropriate ANTONYM of the given word.

**Skeptic**

- Ans**
- 1. Believer
  - 2. Atheist
  - 3. Careful
  - 4. Infidel

Q.12 Select the most appropriate option that can substitute the underlined segment in the given sentence. If there is no need to substitute it, select 'No substitution required'.

He asked his father when would come the next letter.

- Ans
- 1. No substitution required
  - 2. the next letter would come
  - 3. would the next letter come
  - 4. come the next letter

Q.13 Select the most appropriate idiomatic expression that can substitute the underlined segment in the given sentence. Last year art critics praised Animesh as if he were a master, but he turned out to be a pleasure for a short time.

- Ans
- 1. a nine days' wonder
  - 2. a dish fit for Gods
  - 3. a house of cards
  - 4. a bull in a china shop

Q.14 Select the most appropriate option that can substitute the underlined word in the given sentence.

The professor did an objective evaluation.

- Ans
- 1. unfair
  - 2. prejudiced
  - 3. unbiased
  - 4. unjust

Q.15 Select the most appropriate ANTONYM of the given word.  
Comical

- Ans
- 1. Tragic
  - 2. Remedial
  - 3. Farcical
  - 4. Rebellious

Q.16 Select the most appropriate option to fill in the blank.  
The bride had a big villa in comparison to the bridegroom's \_\_\_\_\_ house.

- Ans
- 1. large
  - 2. small
  - 3. distinct
  - 4. different

Q.17 Select the INCORRECTLY spelt word.

- Ans
- 1. Aquarium
  - 2. Mantain
  - 3. Accurate
  - 4. Excellence

Q.18 Select the most appropriate meaning of the given idiom.  
bread and butter

- Ans
- 1. An activity you do to get help others
  - 2. An activity you do with determination
  - 3. An activity you do to improve your culinary skills
  - 4. An activity you do to get money for basic needs



Q.19 Select the most appropriate option that can substitute the underlined words in the following sentence.  
If you do hard work, you will have the expected results.

- Ans
- 1. good results
  - 2. required results
  - 3. desired results
  - 4. bad results

Q.20 Select the most appropriate option that can substitute the underlined words in the given sentence.  
Although I have a lot of work to do, I am determined to finish it all by the end of the day so that I can enjoy my weekend not having any imminent due dates.

- Ans
- 1. without any looming deadlines
  - 2. not with any pressure of due date
  - 3. with no pending reservations
  - 4. not leaving any work incomplete

Q.21 Select the most appropriate ANTONYM of the word given in brackets to fill in the blank.  
Her voice, soft and \_\_\_\_\_, (shrill) flowed effortlessly through the room.

- Ans
- 1. mellow
  - 2. nasal
  - 3. croaky
  - 4. piercing

Q.22 Identify the incorrectly spelt word and select its correct spelling.  
It is his previlage to present all the candidates for ordination to the bishop of the diocese.

- Ans
- 1. deocean
  - 2. privilege
  - 3. prevalage
  - 4. odination

Q.23 Select the most appropriate option that can substitute the underlined segment in the given sentence.  
Planets in our solar system close and big for them to twinkle.

- Ans
- 1. is close and big
  - 2. are quite close and big
  - 3. are too close and big
  - 4. very close and big

Q.24 Which of the following sentences contains the ANTONYM of the word 'ignore'?

- Ans
- 1. Avoid foods which make you sick.
  - 2. He did not succeed in gaining custody of his daughter.
  - 3. Ritika recognised Kavita in the gathering.
  - 4. To keep a tidy kitchen, do not neglect washing your dishes.

Q.25 Select the most appropriate connotation to fill in the blank.  
Raju is such a \_\_\_\_\_ always prying into other people's business!

- Ans
- 1. cheeky
  - 2. stingy
  - 3. nosy
  - 4. perky

Q.1 If 'A' stands for '+', 'B' stands for '×', 'C' stands for '+' and 'D' stands for '-', what will come in place of the question mark (?) in the following equation?

$$28 \text{ B } 7 \text{ D } 176 \text{ A } 8 \text{ C } 13 = ?$$

- Ans
- 1. 185
  - 2. 184
  - 3. 187
  - 4. 186

Q.2 How many triangles are there in the given figure?

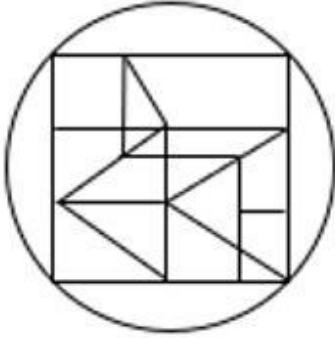

- Ans
- 1. 14
  - 2. 16
  - 3. 15
  - 4. 13

Q.3 What would be the word on the opposite side of 'Kiwi' if the given sheet is folded to form a cube?



- Ans
- 1. Melon
  - 2. Plum
  - 3. Lime
  - 4. Mango

Q.4 What should come in place of ? in the given series based on the English alphabetical order?

TMF UNE VOD ? XQB

- Ans
- 1. KOT
  - 2. WPC
  - 3. ACE
  - 4. WPI

Q.5 What should come in place of the question mark (?) in the given series based on the English alphabetical order?

CPW, HRA, MTE, RVI, ?

Ans  1. VYN

2. VYN

3. XXM

4. WXM

Adda247 Marathi

Q.6 Select the correct mirror image of the given figure when the mirror is placed at MN.

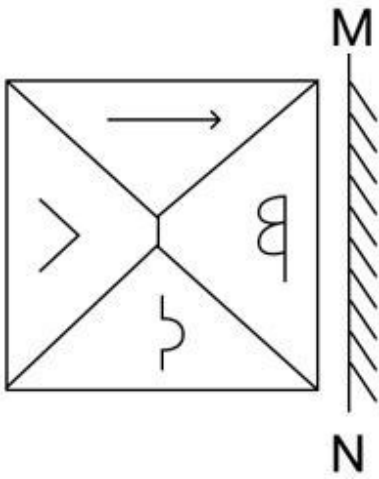

Ans

X 1.

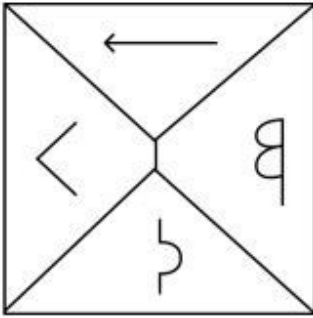

X 2.

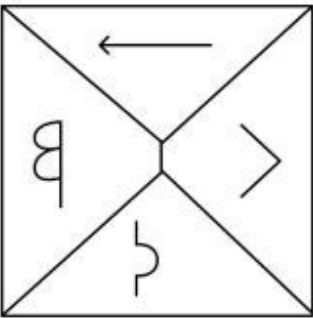

✓ 3.

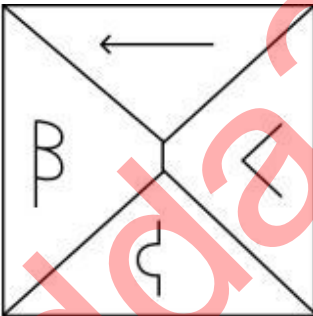

X 4.

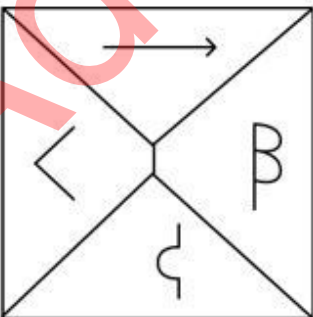

Q.7 ZBRL is related to UWMG in a certain way based on the English alphabetical order. In the same way, IDSQ is related to DYNL. To which of the following is EVNA related, following the same logic?

- Ans
- 1. ZIVQ
  - 2. ZIQV
  - 3. ZQVI
  - 4. ZQIV

Q.8 If 15 August 2006 is a Tuesday, then what will the day of the week on 7 September 2017?

- Ans
- 1. Thursday
  - 2. Wednesday
  - 3. Monday
  - 4. Sunday

Q.9 What should come in place of the question mark (?) in the given series?  
23, 27, 35, 47, 63, ?

- Ans
- 1. 83
  - 2. 84
  - 3. 85
  - 4. 82

Q.10 In a certain code language, 'RUIN' is coded as '3098' and 'TURN' is coded as '9630'. How is 'I' coded in the given language?

- Ans
- 1. 6
  - 2. 3
  - 3. 8
  - 4. 9

Q.11 YZWT is related to DEAX in a certain way based on the English alphabetical order. In the same way, QROL is related to VWSP. To which of the following is RSPM related, following the same logic?

- Ans
- 1. WXTQ
  - 2. WXUQ
  - 3. WYUQ
  - 4. WTXQ

Q.12 What will come in the place of the question mark (?) in the following equation if '+' and '÷' are interchanged and '×' and '-' are interchanged?

$$39 + 13 \times 12 \div 5 - 4 = ?$$

- Ans
- 1. 13
  - 2. 11
  - 3. 9
  - 4. 7

Q.13 Three of the following four are alike in a certain way and thus form a group. Which is the one that does NOT belong to that group?  
(Note: The odd one out is not based on the number of consonants/vowels or their position in the letter cluster.)

- Ans
- 1. PSU
  - 2. HKN
  - 3. TWZ
  - 4. DGJ

Q.14 Which two numbers should be interchanged to make the given equation correct?

$$136 - (176 \div 11) \times 8 + 22 \times 3 = 105$$

(NOTE: Numbers must be interchanged and not the constituent digits e.g. if 2 and 3 are to be interchanged in the equation  $4 \div 2$ , then interchanged equation is  $43 \times 2 + 4 \div 3$ )

- Ans
- 1. 1 and 22
  - 2. 8 and 3
  - 3. 22 and 176
  - 4. 8 and 11

Q.15 Select the correct mirror image of the given figure when the mirror is placed at MN as shown below.

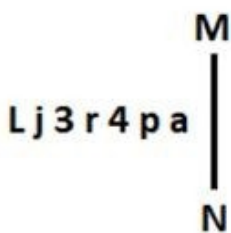

- Ans
- 1. pa4rεjL
  - 2. sd4rεjL
  - 3. sq4rεjL
  - 4. jr4bs

Q.16 Select the word-pair that best represents a similar relationship to the one expressed in the pair of words given below.  
(The words must be considered as meaningful English words and must not be related to each other based on the number of letters/number of consonants/vowels in the word.)  
Light : Blind

- Ans
- 1. Voice : Vibration
  - 2. Tongue : Sound
  - 3. Language : Deaf
  - 4. Speech : Dumb

Q.17

What would be the word on the opposite side of 'Feb' if the given sheet is folded to form a cube?



- Ans
- 1. June
  - 2. Jan
  - 3. May
  - 4. Mar

Q.18 In a certain code language, 'AUDIO' is coded as '59416' and 'BEND' is coded as '6238'. How is 'D' coded in that language?

- Ans
- 1. 6
  - 2. 4
  - 3. 2
  - 4. 1

Q.19 Select the set in which the numbers are related in the same way as are the numbers of the following sets.  
(NOTE: Operations should be performed on the whole numbers, without breaking down the numbers into its constituent digits. E.g. 13 – Operations on 13 such as adding/subtracting/multiplying etc. to 13 can be performed. Breaking down 13 into 1 and 3 and then performing mathematical operations on 1 and 3 is not allowed.)  
(12, 132, 11)  
(13, 104, 8)

- Ans
- 1. (9, 128, 14)
  - 2. (16, 146, 9)
  - 3. (7, 105, 15)
  - 4. (18, 132, 7)

Q.20 14 is related to 126 following a certain logic. Following the same logic, 21 is related to 189. To which of the following is 32 related following the same logic?  
(NOTE : Operations should be performed on the whole numbers, without breaking down the numbers into its constituent digits. E.g. 13 – Operations on 13 such as adding /deleting /multiplying etc., to 13 can be performed. Breaking down 13 into 1 and 3 and then performing mathematical operations on 1 and 3 is not allowed.)

- Ans
- 1. 288
  - 2. 320
  - 3. 286
  - 4. 318

Q.21 Identify the figure given in the options that when put in place of the question mark (?) will logically complete the series.

☆	F	3	0	0	△	F	3	
	△		☆		B		0	?
0	3	F	△	3	F	△	B	

Ans

✗ 1.

B		△
	9	
3		F

✗ 2.

B		△
	3	
0		F

✗ 3.

△		F
	9	
B		3

✓ 4.

3		B
	9	
F		△

Q.22 'A ÷ B' means 'A is B's son'.  
 'A × B' means 'A is B's sister'.  
 'A + B' means 'A is B's brother'.  
 'A - B' means 'A is B's mother'.  
 Using the mathematical operators meaning the same as given above, which of the following means that 'S is T's husband'?

- Ans
- ✗ 1.  $T \times R - V + S$
  - ✗ 2.  $T - R \div V \times S$
  - ✓ 3.  $T - R + V \div S$
  - ✗ 4.  $T \div R \times V + S$

Q.23 What will come in the place of the question mark (?) in the following equation, if '+' and '-' are interchanged and '×' and '÷' are interchanged?

$$13 \div 3 + 2 \times 2 - 11 = ?$$

- Ans
- ✗ 1. 59
  - ✗ 2. 39
  - ✗ 3. 29
  - ✓ 4. 49



**Q.24** A square sheet of paper is folded along the dotted line successively along the directions shown and is then punched in the last. How would the paper look when unfolded?

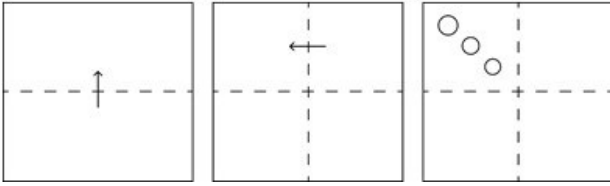

**Ans**

1.

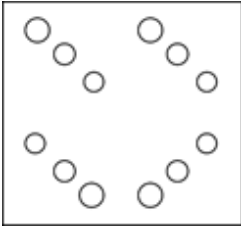

2.

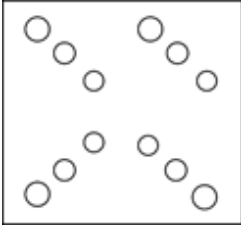

3.

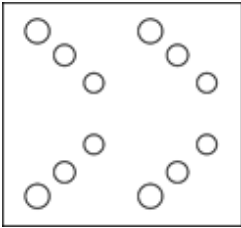

4.

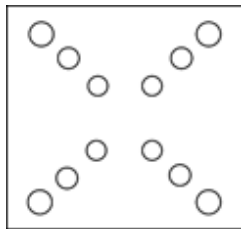

**Q.25** In this question, three statements are given, followed by three conclusions numbered I, II and III. Assuming the statements to be true, even if they seem to be at variance with commonly known facts, decide which of the conclusion(s) logically follows/follow from the statements.

**Statements:**

Some lions are panthers.

No panther is a tiger.

Some lions are cats.

**Conclusions:**

I. No tiger is a cat.

II. Some lions are tiger.

III. No cat is a panther.

**Ans**

1. Only conclusion I follow.

2. Neither conclusions I, II nor III follows.

3. Both conclusions II and III follow.

4. Both conclusions I and II follow.

**Section : Quantitative Aptitude**

**Q.1** If the length, breadth and total surface area of a cuboid are 30 cm, 20 cm and  $2600 \text{ cm}^2$ , respectively, then find its height.

**Ans**

1. 30 cm

2. 15 cm

3. 50 cm

4. 14 cm

2. A train 550 metres long is running at a speed of 78 km/h. How many seconds will it take to cross a 350 metres long train running in the opposite direction at a speed of 30 km/h?

- Ans
- 1. 40 seconds
  - 2. 20 seconds
  - 3. 50 seconds
  - 4. 30 seconds

Q.3 Evaluate the given expression.

$$\left[ 7 + 9 - 2 \left\{ \left( 3 \div \frac{1}{3} \right) - 3 \right\} + 27 \div 3 + (27 \div 9 + 3) - 6 \right] + 2$$

- Ans
- 1. 15
  - 2. 19
  - 3. 22
  - 4. 20

Q.4 What is the area (in  $\text{cm}^2$ ) of an equilateral triangle whose perimeter is 24 cm?  
Note: Round off to the nearest two decimal places.

- Ans
- 1. 28.14
  - 2. 27.71
  - 3. 13.86
  - 4. 27.14

Q.5 R gives  $\frac{3}{8}$  of the toffees he has with him to S. If now R has k% of the toffees with S, then find the value of k.

- Ans
- 1.  $\frac{200}{3}$
  - 2. 200
  - 3.  $\frac{500}{3}$
  - 4. 140

Q.6 A retailer gets a discount of 40% on the printed price of an article. If the retailer sells it at the printed price, then his gain percentage is:

- Ans
- 1.  $66\frac{1}{3}\%$
  - 2.  $66\frac{2}{3}\%$
  - 3.  $37\frac{2}{3}\%$
  - 4.  $33\frac{1}{3}\%$

Q.7 The mean proportion of 0.14 and 2.24 is:

- Ans
- 1. 1.02
  - 2. 1.12
  - 3. -2.39
  - 4. 0.56

Q.8 The following table represents the number of computers (in thousands) manufactured by four companies during the period from 2010 to 2014:

Years	A	B	C	D
2010	240	120	270	280
2011	300	530	490	650
2012	1250	650	430	710
2013	470	320	1180	890
2014	320	1070	550	480

What is the difference (in thousands) between the number of computers manufactured by company A and C during the period from 2010 to 2014?

- Ans
- 1. 230
  - 2. 430
  - 3. 320
  - 4. 340

Q.9 If the ratio of principal and simple interest for 5 years is 10 : 7, then the rate of interest per annum is:

- Ans
- 1. 10%
  - 2. 15%
  - 3. 14%
  - 4. 11%

Q.10 A mobile phone dealer buys a phone for ₹10,000 and sells it for ₹12,000. Later, he realizes that he could have sold it for ₹13,000. What is the percentage loss that he incurs?

- Ans
- 1. 10%
  - 2. 20%
  - 3. 15%
  - 4. 25%

Q.11 A quantity  $\frac{4}{5}$  is changed to  $\frac{5}{6}$ . How much percentage change is given to the quantity?

- Ans
- 1. 4.71%
  - 2. 4.73%
  - 3. 4.17%
  - 4. 4.37%

Q.12 In an assembly election, a candidate got 60% of the total valid votes. 3% of the total votes were declared invalid. If the total number of voters is 2,40,000, then find the number of valid votes polled in favour of the candidate.

- Ans
- 1. 193680
  - 2. 139680
  - 3. 139860
  - 4. 139608

Q.13 The perpendicular length from the origin to the line  $6x + 8y - 48 = 0$  is:

- Ans
- 1. 2.6 unit
  - 2. 4.8 unit
  - 3. 8.3 unit
  - 4. 5.2 unit

Q.14 A work can be done by a man and a woman in 12 days and 8 days, respectively. In how many days will the work be done by 6 men and 4 women?

- Ans
- 1. 1
  - 2.  $\frac{1}{2}$
  - 3. 2
  - 4.  $\frac{3}{4}$

Q.15 A motorcyclist rides his motorcycle at a speed of 90 km/hr in the first one hour and the next two hours at a speed of 120 km/hr. Find the average speed of the rider.

- Ans
- 1. 110 km/hr
  - 2. 120 km/hr
  - 3. 105 km/hr
  - 4. 115 km/hr

Q.16 After the division of a number successively by 2,3 and 5, the remainders are 1,2 and 3, respectively. What will be the remainder, if 13 divides the same number (if the last quotient is 1)?

- Ans
- 1. 1
  - 2. 2
  - 3. 0
  - 4. 3

Q.17 Study the given table and answer that question that follows.  
The given table shows the loan disbursed by five banks (in crores) over four years.

Banks	2016	2017	2018	2019
A	15	20	10	12
B	15	20	15	20
C	20	25	15	20
D	15	20	35	10
E	10	20	25	30

Which two banks have disbursed the same sum of loan over all four years?

- Ans
- 1. A and B
  - 2. B and C
  - 3. C and D
  - 4. B and D

Q.18 If the angle of the sector with radius 7 cm is  $120^\circ$  then find the length of the sector (in cm). (Use  $\pi = \frac{22}{7}$ )

- Ans
- 1.  $\frac{67}{3}$
  - 2.  $\frac{22}{3}$
  - 3.  $\frac{47}{3}$
  - 4.  $\frac{44}{3}$

Q.19 In a triangle ABC, BD is perpendicular to AC. E is a point on BC such that angle BEA =  $x^\circ$ . If angle EAC =  $38^\circ$  and angle EBD =  $40^\circ$ , then the value of  $x$  is:

- Ans
- 1. 82
  - 2. 88
  - 3. 96
  - 4. 48

Q.20 Find the percentage increase in surface area of a cube by triple each side.

- Ans
- 1. 800%
  - 2. 650%
  - 3. 700%
  - 4. 500%

Q.21 If  $\theta$  be acute angle and  $\cos \theta = \frac{24}{25}$ , then the value of  $\cot(90 - \theta)$  is equal to:

- Ans
- 1.  $\frac{5}{24}$
  - 2.  $\frac{7}{24}$
  - 3.  $\frac{7}{25}$
  - 4.  $\frac{6}{25}$

Q.22 Two parallel chords are drawn in a circle of radius 25 cm. The distance between the two chords is 27 cm. If the length of one chord is 48 cm, then length of the other chord is equal to:

- Ans
- 1. 42 cm
  - 2. 36 cm
  - 3. 48 cm
  - 4. 30 cm

Q.23

Study the given graph and answer the question that follows.

The graph shows the number of projects completed by five companies

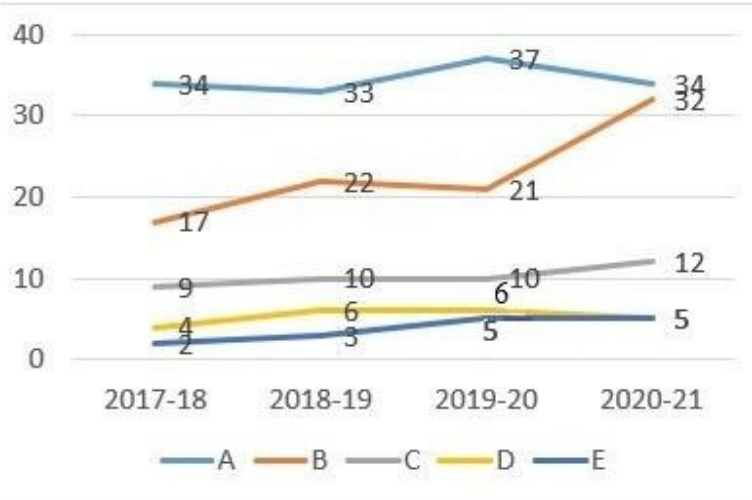

Which company has the highest growth in percentage in completed projects from 2017-18 to 2020-21?

- Ans
- 1. C
  - 2. A
  - 3. B
  - 4. D

Q.24 If three spheres of radius 75 cm, 60 cm and 45 cm are melted into one big sphere, then the radius of the big sphere is:

- Ans
- 1. 90 cm
  - 2. 85 cm
  - 3. 95 cm
  - 4. 80 cm

Q.25 Following Pie chart presents monthly expenditure by Sushma and Preeti in different heads. Sushma and Preeti make equal expenditure every month.

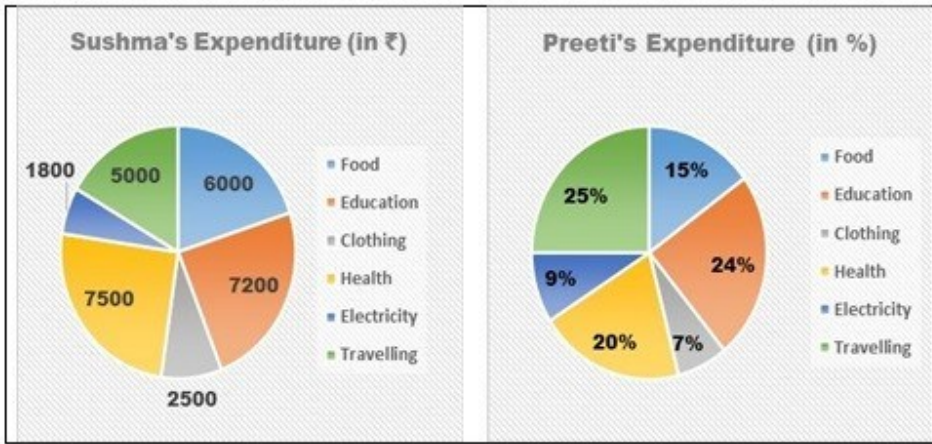

What is the difference between the central angle corresponding to the expenditure incurred on Health by Sushma and Preeti?

- Ans
- 1.  $102^\circ$
  - 2.  $18^\circ$
  - 3.  $12^\circ$
  - 4.  $112^\circ$

Section : General Awareness

1. Which of the following represents the Two-Factor Authentication (2FA)?

- Ans
- 1. A technique for organising files and folders on a PC
  - 2. A tool for optimising system resources
  - 3. The use of two different credentials to verify identity
  - 4. A security measure to prevent physical damage to a PC

2. Former Karnataka CM \_\_\_\_\_ received the Padma Vibhushan at Rashtrapati Bhavan in New Delhi for his contribution in the field of Public Affairs in 2023.

- Ans
- 1. D Devaraj Urs
  - 2. HD Deve Gowda
  - 3. S Nijalingappa
  - 4. SM Krishna

3. According to the Census of India-2011, which state has the lowest sex ratio?

- Ans
- 1. Maharashtra
  - 2. Haryana
  - 3. Rajasthan
  - 4. Bihar

Q.4 Which view in MS PowerPoint is useful for editing or formatting a single slide at a time?

- Ans
- 1. Reading view
  - 2. Slide Sorter view
  - 3. Outline view
  - 4. Normal view

Q.5 Which of the following Articles in the Constitution of India provides protection to President and Governors and Rajpramukhs?

- Ans
- 1. Article 361
  - 2. Article 352
  - 3. Article 370
  - 4. Article 356

Q.6 As on 31 March 2024, apart from the Ministry of Home Affairs, which of the following ministries is headed by Shri Amit Shah?

- Ans
- 1. Ministry of Cooperation
  - 2. Ministry of Minority Affairs
  - 3. Ministry of Coal
  - 4. Ministry of Corporate Affairs

Q.7 Which was the first dynasty of the Delhi Sultanate?

- Ans
- 1. Tughlaq dynasty
  - 2. Khilji dynasty
  - 3. Mamluk dynasty
  - 4. Lodi dynasty

Q.8 When was air transport nationalised in India?

- Ans
- 1. 1950
  - 2. 1951
  - 3. 1952
  - 4. 1953

Q.9 Which of the following is one of the largest spiral galaxies?

- Ans
- 1. NGC 6872
  - 2. Milky Way
  - 3. Cygnus A
  - 4. Maffei 1

Q.10 Which device is used to measure the current flow using needle deflection caused by a magnetic field force acting upon a current-carrying wire?

- Ans
- 1. Galvanometer
  - 2. Psophometer
  - 3. Potentiometer
  - 4. Ammeter

Q.11 The Ayush Ministry has collaborated with the UK's London School of Hygiene and Tropical Medicine (LSHTM) to conduct a study on \_\_\_\_\_ for promoting recovery from COVID-19.

- Ans
- 1. Gotu Kola
  - 2. Boswellia
  - 3. Ashwagandha
  - 4. Brahmi

Q.12 Sangeeta Shankar was awarded Sangeet Natak Akademi Award 2021 for her contribution in playing which musical instrument?

- Ans
- 1. Santoor
  - 2. Veena
  - 3. Violin
  - 4. Flute



Q.13 Of which of the following states/UTs is Rauf a folk dance?

- Ans
- 1. Lakshadweep
  - 2. Jammu and Kashmir
  - 3. Kerala
  - 4. Karnataka

Q.14 'Ujjwala', a \_\_\_\_\_, was the official mascot of Khelo India – Para Games 2023.

- Ans
- 1. goose
  - 2. sparrow
  - 3. duck
  - 4. hen

Q.15 Which of the following exchange rates is determined by the market forces of demand and supply?

- Ans
- 1. Soft pegged exchange rate
  - 2. Floating exchange rate
  - 3. Fixed exchange rate
  - 4. Hard pegged exchange rate

Q.16 With which of the following communities is the word 'Langar' (community kitchen) mainly associated?

- Ans
- 1. Jainism
  - 2. Buddhism
  - 3. Hinduism
  - 4. Sikhism

Q.17 Which city hosted the Asian Champions Trophy hockey tournament in 2023?

- Ans
- 1. Delhi
  - 2. Surat
  - 3. Chennai
  - 4. Ahmedabad

Q.18 The district of Shivamogga that is famous for its Iron-Ore and Manganese mineral is located in which state of India?

- Ans
- 1. Karnataka
  - 2. Maharashtra
  - 3. Rajasthan
  - 4. Jharkhand

Q.19 During 2015, in \_\_\_\_\_ sector, Government of India had allowed about 49% of FDI.

- Ans
- 1. education
  - 2. defence
  - 3. manufacture of medical devices
  - 4. food products

Q.20 Community tradition is related to which of the following music streams?

- Ans
- 1. Karnataka Lokgeet
  - 2. Hindustani Classical Music
  - 3. Hindustani Lokgeet
  - 4. Karnataka Classical Music

Q.21 As per the Census of India-2011, the density of population per km<sup>2</sup> was \_\_\_\_\_ persons.

- Ans
- 1. 320
  - 2. 382
  - 3. 345
  - 4. 394

Q.22 The Central Office of the Reserve Bank of India was initially established in which present city in 1935?

- Ans
- 1. Delhi
  - 2. Mumbai
  - 3. Kolkata
  - 4. Chennai

Q.23 Which of the following reactions leads to the formation of glucose pentaacetate from acetic anhydride?

- Ans
- 1. Acetylation of glucose
  - 2. Oxidation
  - 3. Addition of ketone
  - 4. Reduction

Q.24 In kabaddi, when a raider touches any body part of any defender or any part of their clothing, it is called:

- Ans
- 1. catch
  - 2. tag
  - 3. pursuit
  - 4. raid

Q.25 From which of the following Constitutions has the India Constitution adopted the system of 'First Past the Post'? Ans

- 1. Irish Constitution
- 2. United States Constitution
- 3. French Constitution
- 4. British Constitution

## Combined Higher Secondary Level Examination 2024 Tier I

Exam Date	05/07/2024
Exam Time	5:15 PM - 6:15 PM
Subject	CHSL Exam 2024 Tier I

### Section : English Language

1. Select the most appropriate option to fill in the blank.  
He \_\_\_\_\_ the truth.

Ans  1. spoken  
 2. speaking  
 3. spoke  
 4. speak

2. The following sentence has been divided into four segments. Identify the segment in which the article has been used INCORRECTLY.  
Ms. Rose is a / sweetest of / all the girls / in the class.

Ans  1. sweetest of  
 2. all the girls  
 3. in the class.  
 4. Ms. Rose is a

3. The following sentence has been divided into four segments. Identify the segment that contains a grammatical error. The shop / usually opened / ten minutes / late.

Ans  1. usually opened  
 2. late.  
 3. The shop  
 4. ten minutes

- Q.4 The following sentence has been split into four segments. Identify the segment that contains a grammatical error. I am going / to buy a red car / with a leather seats / and a sunroof.

Ans  1. I am going  
 2. and a sunroof  
 3. to buy a red car  
 4. with a leather seats

**Comprehension:**

In the following passage, some words have been deleted. Read the passage carefully and select the most appropriate option to fill in each blank.

Today, lets explore the significant role of human beings in shaping the world as we know it. Can you 1. \_\_\_\_\_ a world without human beings? Who would have 2. \_\_\_\_\_ the resources and created social and cultural environment? The people are 3. \_\_\_\_\_ to develop the economy and the society. The people make and use resources and are themselves resources with 4. \_\_\_\_\_ quality. Coal is but a piece of rock, until people were able to 5. \_\_\_\_\_ technology to obtain it and make it a 'resource'.

**SubQuestion No : 5****Q.5 Select the most appropriate option to fill in blank number 1.**

- Ans
- 1. ignore
  - 2. fabricate
  - 3. neglect
  - 4. imagine

**Comprehension:**

In the following passage, some words have been deleted. Read the passage carefully and select the most appropriate option to fill in each blank.

Today, lets explore the significant role of human beings in shaping the world as we know it. Can you 1. \_\_\_\_\_ a world without human beings? Who would have 2. \_\_\_\_\_ the resources and created social and cultural environment? The people are 3. \_\_\_\_\_ to develop the economy and the society. The people make and use resources and are themselves resources with 4. \_\_\_\_\_ quality. Coal is but a piece of rock, until people were able to 5. \_\_\_\_\_ technology to obtain it and make it a 'resource'.

**SubQuestion No : 6****Q.6 Select the most appropriate option to fill in blank number 2.**

- Ans
- 1. broken
  - 2. destroyed
  - 3. crippled
  - 4. utilised

**Comprehension:**

In the following passage, some words have been deleted. Read the passage carefully and select the most appropriate option to fill in each blank.

Today, lets explore the significant role of human beings in shaping the world as we know it. Can you 1. \_\_\_\_\_ a world without human beings? Who would have 2. \_\_\_\_\_ the resources and created social and cultural environment? The people are 3. \_\_\_\_\_ to develop the economy and the society. The people make and use resources and are themselves resources with 4. \_\_\_\_\_ quality. Coal is but a piece of rock, until people were able to 5. \_\_\_\_\_ technology to obtain it and make it a 'resource'.

**SubQuestion No : 7****Q.7 Select the most appropriate option to fill in blank number 3.**

- Ans
- 1. crucial
  - 2. frantic
  - 3. hopeful
  - 4. hasty

**Comprehension:**

In the following passage, some words have been deleted. Read the passage carefully and select the most appropriate option to fill in each blank.

Today, lets explore the significant role of human beings in shaping the world as we know it. Can you 1. \_\_\_\_\_ a world without human beings? Who would have 2. \_\_\_\_\_ the resources and created social and cultural environment? The people are 3. \_\_\_\_\_ to develop the economy and the society. The people make and use resources and are themselves resources with 4. \_\_\_\_\_ quality. Coal is but a piece of rock, until people were able to 5. \_\_\_\_\_ technology to obtain it and make it a 'resource'.

**SubQuestion No : 8****Q.8 Select the most appropriate option to fill in blank number 4.**

- Ans
- 1. deviating
  - 2. alternating
  - 3. inconstant
  - 4. varying

**Comprehension:**

In the following passage, some words have been deleted. Read the passage carefully and select the most appropriate option to fill in each blank.

Today, lets explore the significant role of human beings in shaping the world as we know it. Can you 1.\_\_\_\_\_a world without human beings? Who would have 2.\_\_\_\_\_the resources and created social and cultural environment? The people are 3.\_\_\_\_\_to develop the economy and the society. The people make and use resources and are themselves resources with 4.\_\_\_\_\_quality. Coal is but a piece of rock, until people were able to 5.\_\_\_\_\_technology to obtain it and make it a 'resource'.

**SubQuestion No : 9**

**Q.9** Select the most appropriate option to fill in blank number 5.

- Ans
- 1. fashion
  - 2. mint
  - 3. invent
  - 4. open

**Q.10** Identify the most appropriate ANTONYM of the underlined word in the given sentence.  
His joyial nature has won him many friends.

- Ans
- 1. Shrewd
  - 2. Miserable
  - 3. Dumb
  - 4. Cunning

**Q.11** Select the most appropriate ANTONYM of the given word.

Lazy

- Ans
- 1. Barren
  - 2. Helpful
  - 3. Diligent
  - 4. Genuine

**Q.12** Select the most appropriate meaning of the given idiom.

Spill the beans

- Ans
- 1. To help someone extraordinarily
  - 2. To leak a secret
  - 3. The act of loving beans
  - 4. Cook the beans carefully

**Q.13** Identify the most appropriate meaning of the given word.

Accept

- Ans
- 1. Agree
  - 2. Refuse
  - 3. Present
  - 4. Regret

**Q.14** Select the most appropriate ANTONYM of the word 'Plausible' from the given sentence.

The trend of improvement is unlikely to continue for the foreseeable future.

- Ans
- 1. unlikely
  - 2. trend
  - 3. foreseeable
  - 4. future

Q.15 Select the most appropriate option to fill in the blank.

The grass on my lawn is glistening with the morning \_\_\_\_\_.

- Ans
- 1. duo
  - 2. due
  - 3. dew
  - 4. do

Q.16 Select the most appropriate option that can substitute the underlined segment in the given sentence.  
Vihaan is clumsy at dancing.

- Ans
- 1. all thumbs
  - 2. easy handed
  - 3. master skill
  - 4. heavy duty

Q.17 Select the option to fill in the blank with the most appropriate collocation.  
In boarding schools, students need to \_\_\_\_\_ by themselves.

- Ans
- 1. wash the bed
  - 2. turn the bed
  - 3. make the bed
  - 4. run the bed

Q.18 Select the INCORRECTLY spelt word.

- Ans
- 1. Scatered
  - 2. Brazen
  - 3. Crowded
  - 4. Imprudent

Q.19 Select the most appropriate option that can substitute the underlined segment in the following sentence.  
Play cards is not allowed here

- Ans
- 1. Play card
  - 2. Played cards
  - 3. Playing cards
  - 4. Playing card

Q.20 Identify the correct spelling of the underlined word.  
The police issued a varant to the criminals.

- Ans
- 1. Warant
  - 2. Varrant
  - 3. Warent
  - 4. Warrant

Q.21 Select the most appropriate synonym of the given word.  
Change

- Ans
- 1. Resolute
  - 2. Renew
  - 3. Adjust
  - 4. Alter

Q.22 Select the most appropriate option to substitute the underlined segment in the following sentence.  
There was a noise that was wake me up.

- Ans
- 1. woken me up
  - 2. has woke me up
  - 3. woke me up
  - 4. wakes me up

Q.23 Select the most appropriate ANTONYM of the given word.

Absurd

- Ans
- 1. Reasonable
  - 2. Foolish
  - 3. Nonsensical
  - 4. Insane

Q.24 Read the sentence carefully and select the most appropriate option to substitute the underlined part.

The crux of the study has been delineated by the researcher.

- Ans
- 1. relevant part
  - 2. fixed limitation
  - 3. collected data
  - 4. central point

Q.25 Select the most appropriate meaning of the underlined idiom in the given sentence.  
When I got an opportunity to start a new business, Ravikanth queered my pitch.

- Ans
- 1. Supported me with money
  - 2. Helped me by standing beside me
  - 3. Ruined my plan
  - 4. Advised me

Section : General Intelligence

Q.1 In a certain code language, 'sanitiser saves us' is written as 'ra kl mq' and 'let us go' is written as 'kl mt ax'. How is 'us' written in the given language?

- Ans
- 1. mt
  - 2. ra
  - 3. kl
  - 4. mq

Q.2 Select the option in which the given figure is embedded (rotation is not allowed).

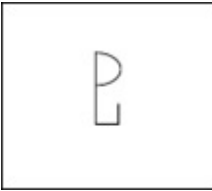

Ans

✗ 1.

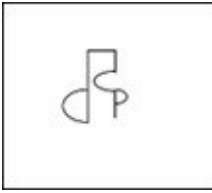

✗ 2.



✗ 3.



✓ 4.

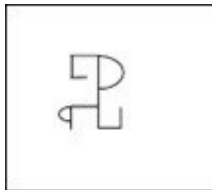

3. The position of how many letters will remain unchanged if all the letters in the word HARMONY are arranged in alphabetical order?

Ans

✗ 1. Four

✗ 2. Three

✓ 3. Two

✗ 4. One

Q.4 CKMZ is related to VDFS in a certain way based on the English alphabetical order. In the same way, LPBV is related to EIUO. To which of the following is UXBN related, following the same logic?

Ans

✗ 1. NGUQ

✗ 2. NGQU

✓ 3. NQUG

✗ 4. NQGU

Q.5 Read the given statements and conclusions carefully. Assuming that the information given in the statements is true, even if it appears to be at variance with commonly known facts, decide which of the given conclusions logically follow(s) from the statements.

Statements:

Some movies are videos.

No video is audio.

All audios are songs.

Conclusions:

(I) All movies can never be audios.

(II) No video is a song.

Ans

✗ 1. None of the conclusions follow

✗ 2. Only conclusion II follows

✓ 3. Only conclusion I follows

✗ 4. Both conclusions I and II follow



Q.6 In a certain code language, 'WILT' is coded as '6194' and 'SLIT' is coded as '9413'. What is the code for 'S' in the given code language?

- Ans
- 1. 4
  - 2. 9
  - 3. 1
  - 4. 3

Q.7 How many triangles are there in the given figure?

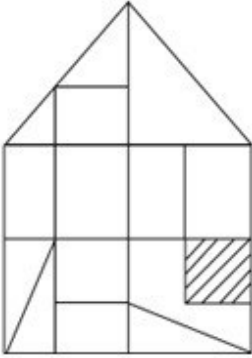

- Ans
- 1. 18
  - 2. 15
  - 3. 17
  - 4. 16

Q.8 What should come in place of ? in the given series?

251, 268, 285, 302, 319 ?

- Ans
- 1. 306
  - 2. 315
  - 3. 326
  - 4. 336

Q.9 Which letter-cluster will replace the question mark (?) to complete the given series?  
GLYC, FNVG, ?, DRPO, CTMS

- Ans
- 1. EQRK
  - 2. EPSK
  - 3. EPRJ
  - 4. EQSJ

Q.10 84 is related to 21 following a certain logic. Following the same logic, 180 is related to 45. To which of the following is 252 related following the same logic?  
(NOTE : Operations should be performed on the whole numbers, without breaking down the numbers into its constituent digits. E.g. 13 – Operations on 13 such as adding /deleting /multiplying etc., to 13 can be performed. Breaking down 13 into 1 and 3 and then performing mathematical operations on 1 and 3 is not allowed.)

- Ans
- 1. 63
  - 2. 67
  - 3. 61
  - 4. 65

Q.11 Select the option in which the given figure X is embedded (rotation is NOT allowed).



(X)

Ans

✗ 1.

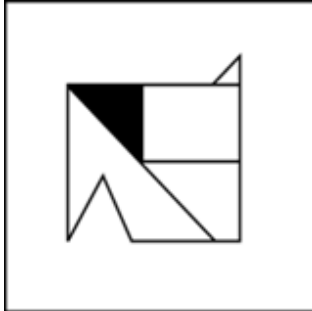

✗ 2.

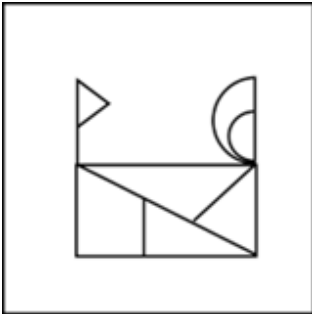

✗ 3.

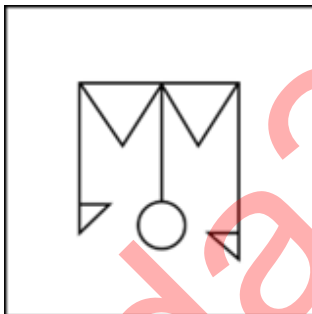

✓ 4.

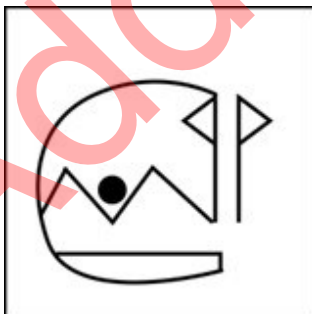

Q.12 Which of the following numbers will replace the question mark (?) in the given series?

876 865 832 733 ?

Ans

✗ 1. 446

✗ 2. 453

✗ 3. 426

✓ 4. 436

Q.13 Select the correct mirror image of the given figure when the mirror is placed at MN as shown below.

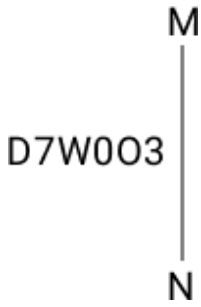

- Ans
- 1.  $\text{D}\overline{\Delta}\text{M}\overline{0}\overline{0}\overline{3}$
  - 2.  $\text{D}\overline{\Delta}\text{M}\overline{0}\overline{0}\overline{3}$
  - 3.  $\text{D}\overline{7}\text{W}\overline{0}\overline{0}\overline{3}$
  - 4.  $\text{D}\overline{7}\text{W}\overline{0}\overline{0}\overline{3}$

Q.14 Select the set in which the numbers are related in the same way as are the numbers of the following sets.  
 (NOTE: Operations should be performed on the whole numbers, without breaking down the numbers into their constituent digits. E.g. 13 – Operations on 13 such as adding/subtracting/multiplying etc. to 13 can be performed. Breaking down 13 into 1 and 3 and then performing mathematical operations on 1 and 3 is not allowed.)  
 (4, 16, 32)  
 (6, 36, 72)

- Ans
- 1. (9, 81, 164)
  - 2. (9, 27, 162)
  - 3. (9, 81, 162)
  - 4. (9, 81, 160)

Q.15 What will be the day on 31 December 2006 if 1 January 2006 is a Wednesday?

- Ans
- 1. Thursday
  - 2. Monday
  - 3. Wednesday
  - 4. Friday

Q.16 Select the correct mirror image of the given figure when the mirror is placed at MN.

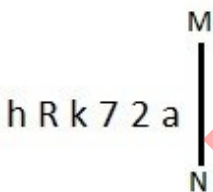

- Ans
- 1.  $\text{h R k 7 2 a}$
  - 2.  $\text{h R k 7 2 a}$
  - 3.  $\text{h R k 7 2 a}$
  - 4.  $\text{h R k 7 2 a}$

Q.17 If 'A' stands for '+', 'B' stands for '×', 'C' stands for '÷' and 'D' stands for '−', what will come in place of the question mark (?) in the following equation?

$$321 \text{ A } 3 \text{ C } 11 \text{ B } 10 \text{ D } 19 = ?$$

- Ans
- 1. 198
  - 2. 188
  - 3. 168
  - 4. 178

Q.18 What should come in place of ? in the given series based on the English alphabetical order?

EMU GQA IUG KYM ?

- Ans
- ✓ 1. MCS
  - ✗ 2. VLB
  - ✗ 3. UKA
  - ✗ 4. MWD

Q.19 What will come in the place of the question mark (?) in the following equation if '+' and '×' are interchanged and '-' and '÷' are interchanged?

$$39 \div 6 - 3 \times 9 + 4 = ?$$

- Ans
- ✗ 1. 56
  - ✗ 2. 83
  - ✓ 3. 73
  - ✗ 4. 81

Q.20 Identify the figure in the options that when put in place of the question mark (?) will logically complete the series?

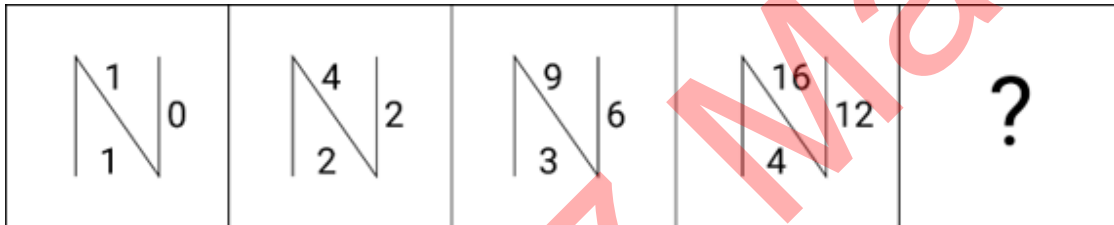

Ans

- ✗ 1.
- ✗ 2.
- ✗ 3.
- ✓ 4.

Q.21  $S \% T = S$  is the father of T.  
 $X - W = X$  is the mother of W.  
 $U * V = U$  is the sister of V.  
 $Z + Y = Z$  is the husband of Y.  
If  $A + J - B * V \% G$ , find the relation between A and G.

- Ans
- 1. Father
  - 2. Paternal grandfather
  - 3. Maternal grandfather
  - 4. Mother

Q.22 In a certain code language,  
'A + B' means 'A is the mother of B',  
'A × B' means 'A is the husband of B',  
'A ÷ B' means 'A is the daughter of B'.  
Based on the above, how is Q related to T if 'P ÷ Q ÷ R × S + T'?

- Ans
- 1. Father's sister
  - 2. Mother
  - 3. Sister
  - 4. Daughter

Q.23 What will come in the place of '?' in the following equation, if '+' and '-' are interchanged and '×' and '÷' are interchanged?

$$32 \times 8 \div 4 - 6 + 15 = ?$$

- Ans
- 1. 7
  - 2. 15
  - 3. 5
  - 4. 13

Q.24 BHJL is related to FLNP in a certain way based on the English alphabetical order. In the same way, HNPR is related to LRTV. To which of the following is JPRT related, following the same logic?

- Ans
- 1. NUVX
  - 2. NTVX
  - 3. NTYX
  - 4. NUWX

Q.25 A paper is folded and cut as shown below. How will it appear when unfolded?

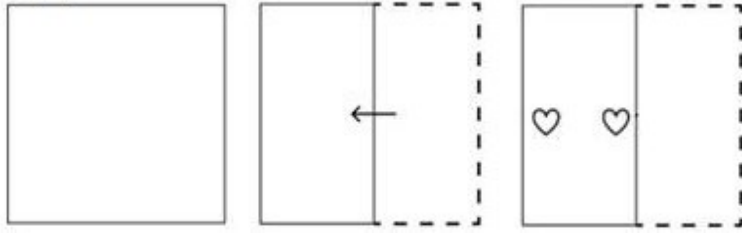

Ans

X 1.

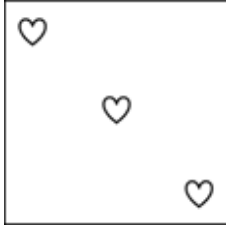

X 2.

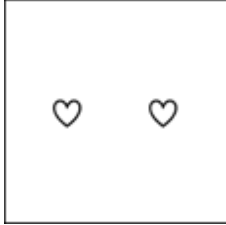

✓ 3.

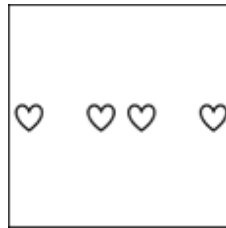

X 4.

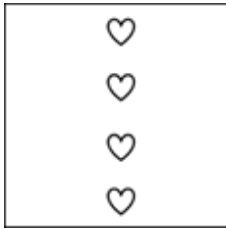

Section : Quantitative Aptitude

Q.1 A shopkeeper cheats 25% in weight while buying rice and cheats 25% while selling it. If he sells the rice at  $12\frac{1}{2}\%$  profit, then find his net profit percentage.

Ans

X 1. 82.5%

X 2. 62.5%

✓ 3. 87.5%

X 4. 92.5%

- Q.2 The following graph shows the data of the production of cloths (in lakh tonnes) by three different companies A, B and C over the years.

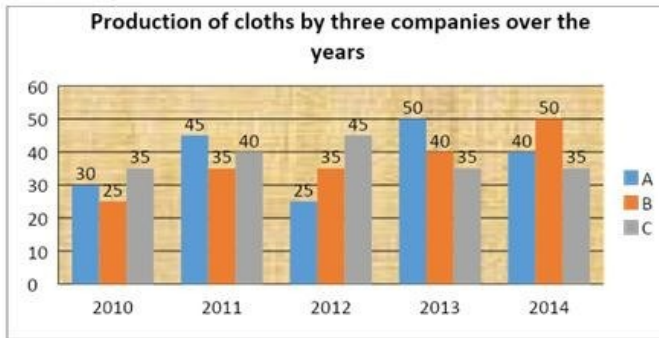

What is the ratio of the average production of Company A in the period 2012-2014 to the average production of Company B in the same period?

- Ans
- 1. 25 : 23
  - 2. 5 : 3
  - 3. 23 : 25
  - 4. 3 : 5

- Q.3 A person travels from one place to another at 60 km/hr and returns at 75 km/hr. If the total time taken is 6 hours, then find the total distance travelled.

- Ans
- 1. 400 km
  - 2. 250 km
  - 3. 240km
  - 4. 300km

- Q.4 Find the fourth proportion to 1.25, 5.75 and 3.5.

- Ans
- 1. 4.5
  - 2. 16.1
  - 3. 6.5
  - 4. 12.5

- Q.5  $\left[ \frac{\operatorname{cosec} 31^\circ - \sec 59^\circ}{(\sin 18^\circ \div \cos 72^\circ)} \times \frac{\tan 26^\circ}{\cot 64^\circ} \right] + \left[ \frac{\tan 30^\circ + \tan 15^\circ}{(1 - \tan 30^\circ \tan 15^\circ)} \right] = \underline{\hspace{2cm}}$ .

- Ans
- 1. 0
  - 2. -1
  - 3. 1
  - 4. 2

- Q.6 Two similar triangles have area 490 sq. cm. and 640 sq. cm. If the length of the one side of the first triangle is 21 cm, then what is the length of the corresponding side of the second triangle?

- Ans
- 1. 24 cm
  - 2. 21 cm
  - 3. 16 cm
  - 4. 14 cm

- Q.7 K being any odd number greater than 1,  $k^{33} - k$  is always divisible by:

- Ans
- 1. 24
  - 2. 13
  - 3. 5
  - 4. 15

- Q.8 Find the amount to be paid at the end if ₹4,500 is invested for a period of 4 years at the rate of 8% simple interest per annum.
- Ans
- 1. ₹5,490
  - 2. ₹6,080
  - 3. ₹5,940
  - 4. ₹6,300

- Q.9 If the graph of the equation  $20x + 21y = 420$  cuts the coordinate axes at P and Q, then what is the measure of the length (in units) of PQ?
- Ans
- 1. 25
  - 2. 29
  - 3. 40
  - 4. 35

- Q.10 Let ABC be a triangle such that  $\angle ABC = 70^\circ$  and  $\angle ACB = 50^\circ$ . Let O be the incentre of the triangle. Find  $\angle BOC$ .
- Ans
- 1.  $120^\circ$
  - 2.  $100^\circ$
  - 3.  $60^\circ$
  - 4.  $130^\circ$

- Q.11 Study the given bar-graph carefully and answer the question that follows.

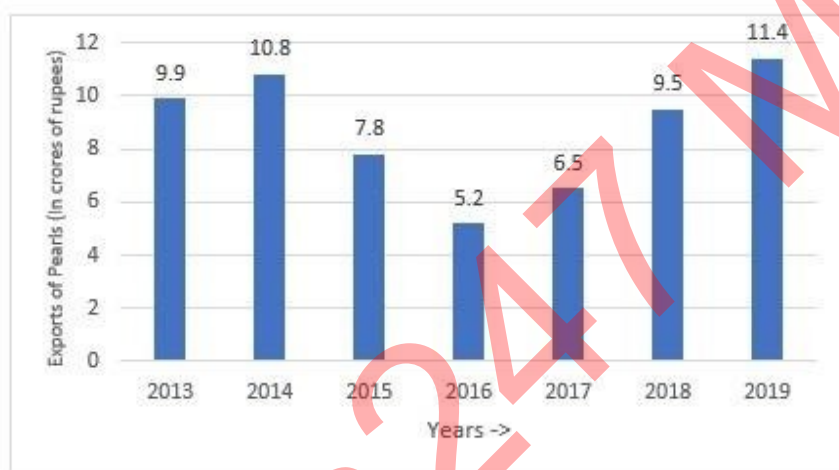

For how many years was the export above - average for the period, 2013-2019?

- Ans
- 1. 1
  - 2. 4
  - 3. 3
  - 4. 2

- Q.12 How many factors of 14,400 are divisible by 18 but not by 36?
- Ans
- 1. 5
  - 2. 2
  - 3. 4
  - 4. 3

- Q.13 A person divides his total route of journey into three equal parts and decides to travel the three parts at the speeds of 80 km/h, 60 km/h and 30 km/h, respectively. What is the average speed during the journey?
- Ans
- 1. 45 km/h
  - 2. 40 km/h
  - 3. 49 km/h
  - 4. 48 km/h



Q.14 Let ABC be a right-angled triangle such that  $\angle C = 90^\circ$ . Let D be a point on AB such that CD is perpendicular to AB. If AC = 5 cm and BC = 12 cm, find the length of CD (in cm).

- Ans
- ✓ 1.  $\frac{60}{13}$
  - ✗ 2.  $\frac{40}{13}$
  - ✗ 3.  $\frac{40}{23}$
  - ✗ 4.  $\frac{50}{23}$

Q.15 The diameter of a roller is 35 cm and its length is 100 cm. It takes 200 complete revolutions to level a playground. Find the area of the playground in  $m^2$

- Ans
- ✗ 1. 1,10,000
  - ✗ 2. 110
  - ✗ 3. 2,20,00,000
  - ✓ 4. 220

Q.16 In an election, a voter has choices to vote for one candidate out of three candidates. There is also an option 'None OfThe Above' (NOTA) to reject all candidates. The three candidates get votes that are 6 times NOTA. The winner gets votes that are twice the second runner-up's votes. The first runner-up gets 900 votes more than NOTA and defeats the second runner-up by 150 votes. What is the total number of votes polled?

- Ans
- ✗ 1. 17715
  - ✗ 2. 15177
  - ✓ 3. 11025
  - ✗ 4. 11577

Q.17 The number of subjects in which the students of a class have failed is given in the following table.

No. of subjects in which students have failed	0	1	2	3	4	5
No. of students	10	18	5	6	7	4

Find the total number of students who have failed in more than 3 subjects.

- Ans
- ✓ 1. 11
  - ✗ 2. 10
  - ✗ 3. 17
  - ✗ 4. 12

Q.18 In  $\triangle ABC$ , O is the point of intersection of the bisectors of angle B and angle A. If the angle  $\angle BOC = 108^\circ$ , then angle BAO is:

- Ans
- ✗ 1.  $26^\circ$
  - ✗ 2.  $16^\circ$
  - ✗ 3.  $22^\circ$
  - ✓ 4.  $18^\circ$

Q.19 The difference (in ₹) between a discount of 37% on ₹2,635 and two successive discounts of 23% and 7% on the same amount is (rounded off to 2 decimal places):

- Ans
- 1. 248.36
  - 2. 226.87
  - 3. 235.65
  - 4. 242.25

Q.20 The following pie chart represents the percentage domestic expenditure of Raman over his family. Study the pie chart carefully and answer the question given below.

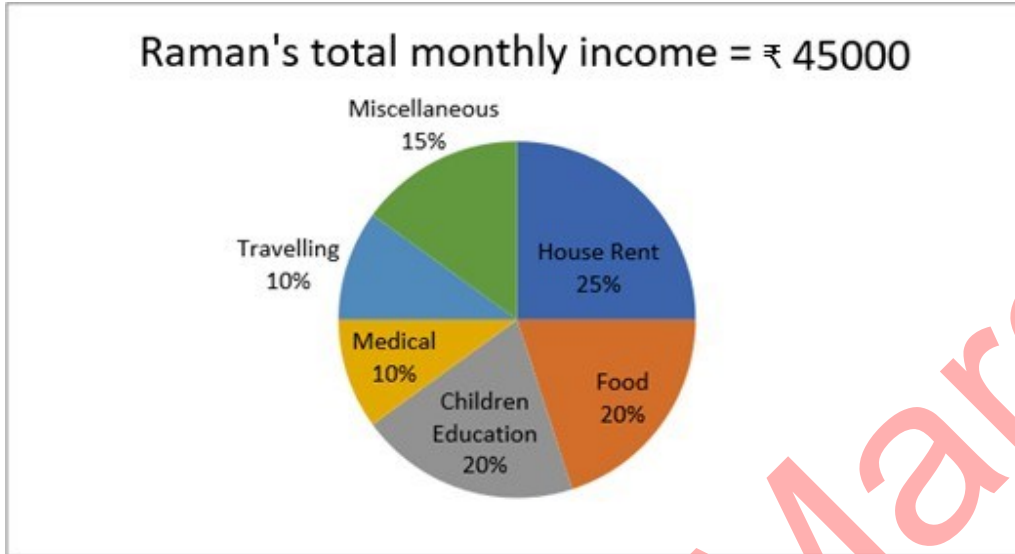

After paying the House Rent and expending over Food and Children's Education, what is Raman's remaining monthly income (in ₹)?

- Ans
- 1. 12,750
  - 2. 20,250
  - 3. 15,750
  - 4. 29,250

Q.21 The price of a motorcycle was \$750 last year. The price increased by 20% this year. What is the price of the motorcycle this year?

- Ans
- 1. \$750
  - 2. \$900
  - 3. \$600
  - 4. \$790

Q.22 The altitude of an equilateral triangle is  $3\sqrt{3}$  cm. Find its area.

- Ans
- 1. 9 sq cm
  - 2. 27 sq cm
  - 3.  $9\sqrt{3}$  sq cm
  - 4.  $3\sqrt{3}$  sq cm

Q.23 X and Y can do a job in 18 days; Y and Z can do the same in 24 days. If all the three can finish the job in 12 days, in how many days can X and Z can complete the job?

- Ans
- 1. 5 days
  - 2.  $12\frac{3}{5}$  days
  - 3. 7 days
  - 4.  $14\frac{2}{5}$  days

Q.24 The whole surface area of a cube is  $294\text{ cm}^2$ . The volume of the cube is:

- Ans
- 1.  $243\text{ cm}^3$
  - 2.  $343\text{ cm}^3$
  - 3.  $512\text{ cm}^3$
  - 4.  $216\text{ cm}^3$

Q.25 A person spends 60% of his salary on family expenses, 10% on medical expenses, 5% on charity, and saves the remaining amount. If the amount on savings is ₹4,000, find his monthly salary.

- Ans
- 1. ₹16,000
  - 2. ₹12,000
  - 3. ₹14,000
  - 4. ₹15,000

Section : General Awareness

1. Where is the Narora Nuclear Power plant located?

- Ans
- 1. Uttar Pradesh
  - 2. Tamil Nadu
  - 3. Maharashtra
  - 4. Karnataka

Q.2 Match the items in List I with those in List II.

**List I**

- i. Blue revolution
- ii. Yellow revolution
- iii. Round revolution
- iv. Golden revolution

**List II**

- a. Oilseeds
- b. Overall horticulture
- c. Fish
- d. Potato

- Ans
- 1. i-d, ii-a, iii-b, iv-c
  - 2. i-c, ii-a, iii-d, iv-b
  - 3. i-b, ii-d, iii-a, iv-c
  - 4. i-b, ii-c, iii-d, iv-a

3. Sardar Vallabhbhai Patel, who was the first Home Minister of India, is known by which sobriquet?

- Ans
- 1. Grand old man of India
  - 2. Iron man of India
  - 3. Morning star of Indian Renaissance
  - 4. Father of Indian Unrest

Q.4 What is the wavelength range of visible light?

- Ans
- 1. 0.2 to 0.3  $\mu\text{m}$
  - 2. 0.7 to 0.9  $\mu\text{m}$
  - 3. 0.4 to 0.7  $\mu\text{m}$
  - 4. 1 to 2  $\mu\text{m}$

Q.5 Terah taali dance belongs to which of the following states?

- Ans
- 1. Kerala
  - 2. Rajasthan
  - 3. Uttarakhand
  - 4. Uttar Pradesh

Q.6 What enables IoT devices to gather data and exchange it over the network?

- Ans
- 1. Actuators and sensors
  - 2. Data encryption techniques
  - 3. Biochip transponders
  - 4. Human interaction

Q.7 As of January 2023, who among the following is the chief minister of Puducherry?

- Ans
- 1. Shri V Narayanasamy
  - 2. Shri N Rangaswamy
  - 3. Shri V Vaithilingam
  - 4. Shri P Shanmugam

Q.8 In which year did the Indian Constitution declare Hindi in Devanagari script to be the official language of the Union?

- Ans
- 1. 1951
  - 2. 1952
  - 3. 1949
  - 4. 1955

Q.9 As per the Economic Survey of India 2022-23, unemployment rates fell from 5.8% in 2018-19 to \_\_\_\_\_ in 2020-21.

- Ans
- 1. 3.8%
  - 2. 4.7%
  - 3. 4.2%
  - 4. 3.4%

Q.10 Who has written the patriotic song 'Sandese Aate Hai'?

- Ans
- 1. Irshad Kamil
  - 2. Samir Anjan
  - 3. Javed Akhtar
  - 4. Gulzar

Q.11 The 'Western disturbances' originates from the \_\_\_\_\_.

- Ans
- 1. East China Sea
  - 2. Mediterranean Sea
  - 3. Arabian Sea
  - 4. Red Sea

Q.12 Bails are used in which of the following games/sports?

- Ans
- 1. Cricket
  - 2. Badminton
  - 3. Football
  - 4. Hockey

Q.13 In Gujarat, the festival Makar Sankranti is celebrated as:

- Ans
- 1. Paschimayan
  - 2. Purbayan
  - 3. Dakshinayan
  - 4. Uttarayan

Q.14 The reaction of an acid and a metal gives:

- Ans
- 1. hydrogen gas and salt
  - 2. carbon dioxide, salt and water
  - 3. salt and water
  - 4. carbon dioxide, salt and hydrogen gas

Q.15 The length of a day on \_\_\_\_\_ is approximately 16 hours.

- Ans
- 1. Mercury
  - 2. Mars
  - 3. Venus
  - 4. Neptune

Q.16 After being passed by both the Lok Sabha and Rajya Sabha, the Competition (Amendment) Bill, 2023 received the President's assent on \_\_\_\_\_ to become the Competition (Amendment) Act, 2023.

- Ans
- 1. 21 April 2023
  - 2. 11 April 2023
  - 3. 1 April 2023
  - 4. 14 April 2023

Q.17 Which among the following Chola emperors defeated the Pandya king Maravarman Rajsimha II in the battle of Vellore?

- Ans
- 1. Rajendra I
  - 2. Vijayalaya
  - 3. Parantaka I
  - 4. Rajaraja I

Q.18 What is the standard size of basketball for men?

- Ans
- 1. 06
  - 2. 07
  - 3. 08
  - 4. 05

Q.19 As of 01 January 2023, who is the chairman of UPSC?

- Ans
- 1. Dr. Manoj Soni
  - 2. Shri Rajeev Nayan Choubey
  - 3. Dr. TCA Anant
  - 4. Mrs. Preeti Sudan

Q.20 Which of the following extensions is used to save MS-PowerPoint applications?

- Ans
- 1. .docx
  - 2. .txt
  - 3. .doc
  - 4. .ppt

Q.21 In India, statutory liquidity ratio is fixed by \_\_\_\_\_.

- Ans
- 1. India Brand Equity Foundation
  - 2. State government
  - 3. Commercial banks
  - 4. Reserve Bank of India

Q.22 Which folk music is a mix of Indian and western music and is popular in Goa?

- Ans
- 1. Mando
  - 2. Maand
  - 3. Pai songs
  - 4. Pawada

Q.23 Pusarla Venkata Sindhu won silver medal in badminton in which Olympics Games?

- Ans
- 1. London 2012
  - 2. Beijing 2008
  - 3. Tokyo 2020
  - 4. Rio 2016

Q.24 Which committee is related to fundamental duties?

- Ans
- 1. Verma Committee
  - 2. LM Singhvi Committee
  - 3. Vasant Rao Naik Committee
  - 4. Rajmanna Committee

Q.25 A \_\_\_\_\_ is issued to prevent an inferior court or tribunal from exceeding its jurisdiction, which is not legally vested, or acting without jurisdiction or acting against the principles of natural justice.

- Ans
- 1. writ of mandamus
  - 2. writ of habeas corpus
  - 3. writ of prohibition
  - 4. writ of quo-warranto

## Combined Higher Secondary Level Examination 2024 Tier I

Exam Date	08/07/2024
Exam Time	9:00 AM - 10:00 AM
Subject	CHSL Exam 2024 Tier I

### Section : English Language

1. The following sentence has been divided into three segments. One of them may contain an adverbial usage error. Select the option that has the segment with the error. If you don't find any error, select 'No error' as your answer.  
Mrs. Arunima / speaks / Telugu well.

- Ans
- 1. speaks
  - 2. Mrs. Arunima
  - 3. Telugu well.
  - 4. No error

2. Parts of the following sentence have been given as options. Select the option that contains an error. According to the encyclopaedia, a oasis is an area which is made fertile by a source of freshwater.

- Ans
- 1. a source of freshwater.
  - 2. a oasis is an area
  - 3. According to the encyclopaedia,
  - 4. which is made fertile by

3. The following sentence has been divided into four segments. Identify the segment that contains a grammatical error. He have / workers from / Ireland and France / in his factory.

- Ans
- 1. in his factory.
  - 2. workers from
  - 3. Ireland and France
  - 4. He have

- Q.4 Select the most appropriate option that can substitute the underlined segment in the given sentence.  
Sarita speaks French best.

- Ans
- 1. worst
  - 2. better
  - 3. good
  - 4. well

**Comprehension:**

In the following passage, some words have been deleted. Read the passage carefully and select the most appropriate option to fill in each blank.

Family plays a vital role in our lives, serving as a source of love, support, and stability. It is (1) \_\_\_\_\_ the family unit that we develop lasting bonds, learn essential values, and find comfort during (2) \_\_\_\_\_ times. Families provide a nurturing environment for personal growth and emotional well-being. They (3) \_\_\_\_\_ guidance, share experiences, and create cherished memories. The strength and (4) \_\_\_\_\_ of a family contribute to individual happiness, societal harmony, and the (5) \_\_\_\_\_ of a strong community.

**SubQuestion No : 5****Q.5 Select the most appropriate option to fill in blank 1.**

- Ans**
- 1. within
  - 2. among
  - 3. beyond
  - 4. between

**Comprehension:**

In the following passage, some words have been deleted. Read the passage carefully and select the most appropriate option to fill in each blank.

Family plays a vital role in our lives, serving as a source of love, support, and stability. It is (1) \_\_\_\_\_ the family unit that we develop lasting bonds, learn essential values, and find comfort during (2) \_\_\_\_\_ times. Families provide a nurturing environment for personal growth and emotional well-being. They (3) \_\_\_\_\_ guidance, share experiences, and create cherished memories. The strength and (4) \_\_\_\_\_ of a family contribute to individual happiness, societal harmony, and the (5) \_\_\_\_\_ of a strong community.

**SubQuestion No : 6****Q.6 Select the most appropriate option to fill in blank 2.**

- Ans**
- 1. joyful
  - 2. challenging
  - 3. initial
  - 4. wasteful

**Comprehension:**

In the following passage, some words have been deleted. Read the passage carefully and select the most appropriate option to fill in each blank.

Family plays a vital role in our lives, serving as a source of love, support, and stability. It is (1) \_\_\_\_\_ the family unit that we develop lasting bonds, learn essential values, and find comfort during (2) \_\_\_\_\_ times. Families provide a nurturing environment for personal growth and emotional well-being. They (3) \_\_\_\_\_ guidance, share experiences, and create cherished memories. The strength and (4) \_\_\_\_\_ of a family contribute to individual happiness, societal harmony, and the (5) \_\_\_\_\_ of a strong community.

**SubQuestion No : 7****Q.7 Select the most appropriate option to fill in blank 3.**

- Ans**
- 1. deliver
  - 2. offer
  - 3. contribute
  - 4. propose

**Comprehension:**

In the following passage, some words have been deleted. Read the passage carefully and select the most appropriate option to fill in each blank.

Family plays a vital role in our lives, serving as a source of love, support, and stability. It is (1) \_\_\_\_\_ the family unit that we develop lasting bonds, learn essential values, and find comfort during (2) \_\_\_\_\_ times. Families provide a nurturing environment for personal growth and emotional well-being. They (3) \_\_\_\_\_ guidance, share experiences, and create cherished memories. The strength and (4) \_\_\_\_\_ of a family contribute to individual happiness, societal harmony, and the (5) \_\_\_\_\_ of a strong community.

**SubQuestion No : 8****Q.8 Select the most appropriate option to fill in blank 4.**

- Ans**
- 1. intrusion
  - 2. cohesion
  - 3. disruption
  - 4. commotion



**Comprehension:**

In the following passage, some words have been deleted. Read the passage carefully and select the most appropriate option to fill in each blank.

Family plays a vital role in our lives, serving as a source of love, support, and stability. It is (1) \_\_\_\_\_ the family unit that we develop lasting bonds, learn essential values, and find comfort during (2) \_\_\_\_\_ times. Families provide a nurturing environment for personal growth and emotional well-being. They (3) \_\_\_\_\_ guidance, share experiences, and create cherished memories. The strength and (4) \_\_\_\_\_ of a family contribute to individual happiness, societal harmony, and the (5) \_\_\_\_\_ of a strong community.

**SubQuestion No : 9**

**Q.9** Select the most appropriate option to fill in blank 5.

- Ans
- 1. foundation
  - 2. undermining
  - 3. collision
  - 4. erosion

**Q.10** Select the most appropriate ANTONYM of the given word.  
Forbidden

- Ans
- 1. Protected
  - 2. Prevented
  - 3. Banned
  - 4. Allowed

**Q.11** Identify the most appropriate ANTONYM of the underlined word based on the context of the sentence.  
He gave a haughty consent without honouring him with a single word.

- Ans
- 1. Proud
  - 2. Happy
  - 3. Modest
  - 4. Indifferent

**Q.12** Select the most appropriate option that can substitute the underlined segment in the given sentence.

We have carried out an successful raid on a fraudulent minister.

- Ans
- 1. the successful raid
  - 2. successful raid
  - 3. these successful raid
  - 4. a successful raid

**Q.13** Select the INCORRECTLY spelt word from the given sentence.  
They were good-hearted girls, unclean, clothed in rags and profiundly ignorant.

- Ans
- 1. Hearted
  - 2. Profiundly
  - 3. Unclean
  - 4. Clothed

**Q.14** Select the most appropriate homophone to fill in the blank.  
The hospital is \_\_\_\_\_ the river.

- Ans
- 1. buy
  - 2. by
  - 3. bye
  - 4. bi

Q.15 Select the most appropriate synonym of the given word.

Erudite

- Ans
- 1. Humble
  - 2. Honest
  - 3. Strong
  - 4. Educated

Q.16 Select the most appropriate meaning of the given idiom.  
Fish out of water

- Ans
- 1. To be out of place
  - 2. No knowledge of marine life
  - 3. To die soon
  - 4. Not good at swimming

Q.17 Select the INCORRECTLY spelt word.

- Ans
- 1. Comendation
  - 2. Reimbursement
  - 3. Competition
  - 4. Intertwined

Q.18 Select the most appropriate option to fill in the blank.

The \_\_\_\_\_ today will be cloudy and humid.

- Ans
- 1. wither
  - 2. waiter
  - 3. weather
  - 4. whether

Q.19 Select the most appropriate option that can substitute the underlined segment in the given sentence.  
Yoga may manage pain and helping reduce stress.

- Ans
- 1. help reduction for
  - 2. helped reduce
  - 3. help reduced
  - 4. help in reducing

Q.20 Select the most appropriate option that can substitute the underlined segment in the given sentence.  
I like played cricket after school.

- Ans
- 1. playing
  - 2. play
  - 3. played
  - 4. having to play

Q.21 Select the most appropriate meaning of the given idiom.  
Bells and whistles

- Ans
- 1. To take on a difficult task
  - 2. An innovative development
  - 3. At a serious disadvantage
  - 4. Attractive but unnecessary features added to products

Q.22 Select the option that will improve the underlined part of the given sentence. In case no improvement is needed, select 'No improvement'.  
Since my friend was not feeling well, she asked me to come over and take care of her.

- Ans
- 1. No improvement
  - 2. come across
  - 3. come into
  - 4. come through

Q.23 Select the most appropriate synonym of the given word.  
Injustice

- Ans
- 1. Discrimination
  - 2. Equality
  - 3. Complacency
  - 4. Demand

Q.24 Select the most appropriate ANTONYM of the given word.  
Generous

- Ans
- 1. Needy
  - 2. Mean
  - 3. Considerate
  - 4. Clever

Q.25 Select the most appropriate option to fill in the blank.  
After finishing all my pending assignments, I plan to \_\_\_\_\_ in Goa.

- Ans
- 1. land a meal
  - 2. forgive a debt
  - 3. take a holiday
  - 4. go bankrupt

Section : General Intelligence

1. What should come in place of the question mark (?) in the given series based on the English alphabetical order?  
DFA, HJE, LNI, PRM, ?

- Ans
- 1. UWR
  - 2. TVO
  - 3. UVP
  - 4. TVQ

Q.2 How many triangles are there in the given figure?

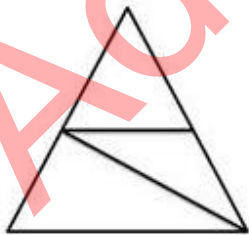

- Ans
- 1. 6
  - 2. 3
  - 3. 5
  - 4. 4

3. In this question, three statements are given, followed by three conclusions numbered I, II and III. Assuming the statements to be true, even if they seem to be at variance with commonly known facts, decide which of the conclusion(s) logically follows/follow from the statements.

Statements:

No copper is silver.

All gold is copper.

All aluminium is gold.

Conclusions:

I. No aluminium is silver.

II. Some gold is silvers

III. All aluminium is copper.

Ans  1. Both conclusions I and II follow.

2. Only conclusion II follows.

3. Only conclusion I follows.

4. Both conclusions I and III follow.

Q.4 In a certain code language, 'watch is disturb' is written as 'xr pa qm' and 'don't watch him' is written as 'tu bg pa'. How is 'watch' written in the given language?

Ans  1. pa

2. bg

3. tu

4. xr

Q.5 Which figure should replace the question mark (?) if the following figure series were to be continued?

Q	S	B	T	=	Q	=	Q	S	F	T	=	
	=		S				T		Q			?
	T		B				F		S			

Ans

1.

Q	F	T
=		
3		

2.

T	=	F
S		
Q		

3.

T	=	Q
F		
3		

4.

=	S	Q
F		
T		

Q.6 In a certain code language,  
 'A + B' means 'A is the mother of B',  
 'A - B' means 'A is the daughter of B',  
 'A × B' means 'A is the husband of B',  
 'A ÷ B' means 'A is the sister of B'.  
 Based on the above, how is M related to Q if 'M ÷ N - O × P + Q'?

- Ans
- 1. Mother
  - 2. Daughter
  - 3. Sister
  - 4. Father's sister

Q.7 What will come in the place of the question mark (?) in the following equation, if '+' and '×' are interchanged and '-' and '÷' are interchanged?

$$44 \div 78 + 6 - 3 \times 19 = ?$$

- Ans
- 1. 68
  - 2. 64
  - 3. 74
  - 4. 78

Q.8 Choose the alternative which closely resembles the mirror image of the given combination.



- Ans
- 1. FOERAC
  - 2. FOERAC
  - 3. FEORAC
  - 4. FOERAC

Q.9 What would be the symbol on the opposite side of '@' if the given sheet is folded to form a cube?

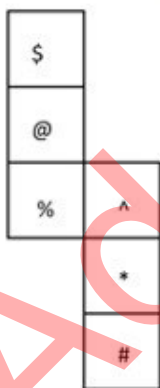

- Ans
- 1. \*
  - 2. %
  - 3. ^
  - 4. #

Q.10 In a certain code language, 'call on him' is coded as 'ol ni vc' and 'awaiting your call' is coded as 'ni dx sb'. How is 'call' coded in that language?

- Ans
- 1. dx
  - 2. ni
  - 3. sb
  - 4. vc

Q.11 Select the word-pair that best represents a similar relationship to the one expressed in the pair of words given below. (The words must be considered as meaningful English words and must not be related to each other based on the number of letters/number of consonants/vowels in the word.)

Withdraw : Extract

- Ans
- 1. Exploit : Utilise
  - 2. Rent : Contrive
  - 3. Explore : Ignore
  - 4. Expend : Relish

Q.12 Which of the following numbers will replace the question mark (?) in the given series?

56, ?, 38, 29, 20

- Ans
- 1. 47
  - 2. 46
  - 3. 42
  - 4. 48

Q.13 Each of the letters in the word MUSICAL is arranged in alphabetical order. How many letters are there in the English alphabetical series between the letter which is fourth from the left and the one which is second from the right in the new letter cluster thus formed?

- Ans
- 1. Seven
  - 2. Six
  - 3. Eight
  - 4. Five

Q.14 Three of the following four are alike in a certain way and thus form a group. Which is the one that does NOT belong to that group?

(Note: The odd one out is not based on the number of consonants/vowels or their position in the letter cluster.)

- Ans
- 1. CEH
  - 2. TVY
  - 3. PQT
  - 4. LNQ

Q.15 WVSO is related to XXUP in a certain way based on the English alphabetical order. In the same way, ONKG is related to PPMH. To which of the following is VURN related, following the same logic?

- Ans
- 1. WWTO
  - 2. XXTP
  - 3. XWSP
  - 4. XXSP

**Q.16** Select the set in which the numbers are related in the same way as are the numbers of the given sets.  
(NOTE: Operations should be performed on the whole numbers, without breaking down the numbers into its constituent digits. E.g., 13 – Operations on 13 such as adding/subtracting/multiplying etc. to 13 can be performed. Breaking down 13 into 1 and 3 and then performing mathematical operations on 1 and 3 is not allowed.)  
(9, 21, 193)  
(12, 15, 184)

- Ans**
- 1. (29, 6, 170)
  - 2. (24, 8, 192)
  - 3. (8, 17, 140)
  - 4. (18, 8, 140)

**Q.17** If 'A' stands for '+', 'B' stands for '×', 'C' stands for '÷' and 'D' stands for '−', what will come in place of the question mark (?) in the following equation?

$$88 \text{ B } 3 \text{ D } 12 \text{ A } 4 \text{ C } 6 = ?$$

- Ans**
- 1. 265
  - 2. 264
  - 3. 267
  - 4. 268

**Q.18** If 19 November 2003 is Wednesday, then what will be the day of the week on 25 March 2011?

- Ans**
- 1. Thursday
  - 2. Friday
  - 3. Sunday
  - 4. Tuesday

**Q.19** 4 is related to 64 following a certain logic. Following the same logic, 9 is related to 729. To which of the following is 12 related following the same logic?  
(NOTE : Operations should be performed on the whole numbers, without breaking down the numbers into its constituent digits. E.g. 13 – Operations on 13 such as adding /deleting /multiplying etc., to 13 can be performed. Breaking down 13 into 1 and 3 and then performing mathematical operations on 1 and 3 is not allowed.)

- Ans**
- 1. 1420
  - 2. 1728
  - 3. 1788
  - 4. 1808

Q.20

A square sheet of paper is folded along the dotted line successively along the directions shown and is then punched in the end. How would the paper look when unfolded?



Ans

X 1.

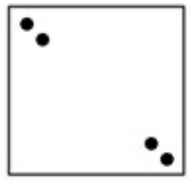

✓ 2.

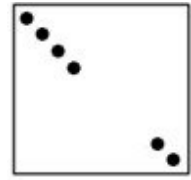

X 3.

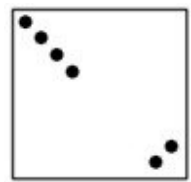

X 4.

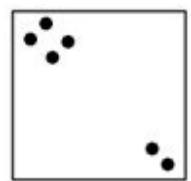

Adda247 Marathi



Q.21 A paper is folded and cut as shown below. How will it appear when unfolded?

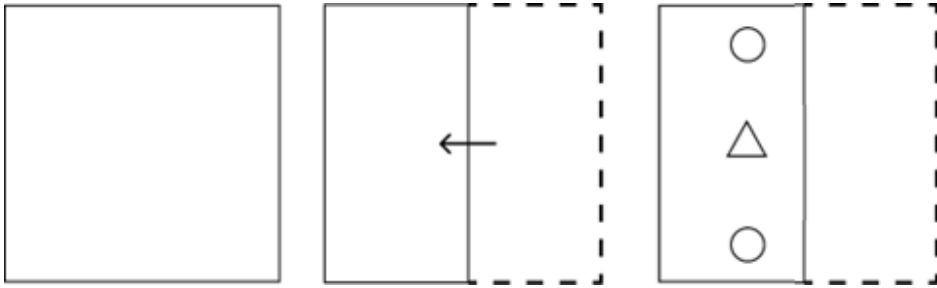

Ans

✗ 1.

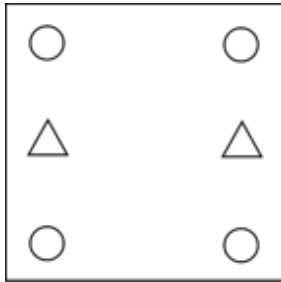

✗ 2.

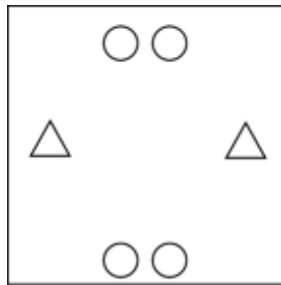

✓ 3.

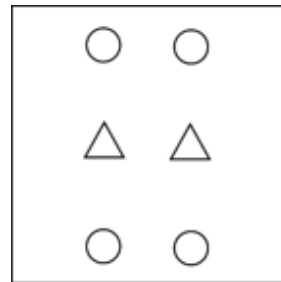

✗ 4.

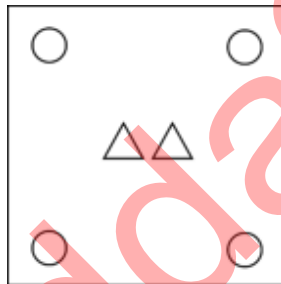

Q.22 What should come in place of the question mark (?) in the given series based on the English alphabetical order?  
GEB, JHE, MKH, PNK, ?

Ans

✗ 1. SNQ

✓ 2. SQN

✗ 3. NQS

✗ 4. NSQ

Q.23 What should come in place of the question mark (?) in the given series?  
56, 53, 50, 47, 44, ?

- Ans
- 1. 41
  - 2. 43
  - 3. 42
  - 4. 40

Q.24 Select the correct mirror image of the given figure when the mirror is placed at MN as shown below.



- Ans
- 1. IRNUEC
  - 2. IREUN
  - 3. IREUNCE
  - 4. IREUN

Q.25 What will come in the place of '?' in the following equation if '+' and '-' are interchanged and 'x' and '÷' are interchanged?  
 $18 \div 9 + 24 \times 3 - 16 = ?$

- Ans
- 1. 450
  - 2. 170
  - 3. 678
  - 4. 980

Section : Quantitative Aptitude

Q.1 The list price of a hand mixer at a showroom is ₹2,000 and it is being sold at successive discounts of 15% and 10%. What is its net selling price in rupees?

- Ans
- 1. 1,600
  - 2. 1,530
  - 3. 1,560
  - 4. 1,440

2. A person borrowed some money at the rate of 8% per annum for the first two years, at the rate of 11% per annum for the next three years, and at the rate of 16% per annum for the period beyond five years. If he pays a total interest of ₹21,400 at the end of nine years, how much money did he borrow (round to the nearest unit) ?

- Ans
- 1. ₹11,938
  - 2. ₹18,738
  - 3. ₹15,938
  - 4. ₹18,938

Q.3 Let C be a circle with center O and AB be a chord of C such that the length of AB is equal to the radius of C. Let D be any point on major arc of AB. Find  $\angle AOB$  and  $\angle ADB$ , respectively.

- Ans
- 1.  $120^\circ; 100^\circ$
  - 2.  $60^\circ; 30^\circ$
  - 3.  $100^\circ; 80^\circ$
  - 4.  $90^\circ; 60^\circ$

Q.4 A's marks in Mathematics are directly proportional to practice time. In 6 hours of practice, A gets 70 marks. What should be the practice time (approximately) to get 90 marks?

- Ans
- 1. 8 hours
  - 2. 8.3 hours
  - 3. 7 hours
  - 4. 7.7 hours

Q.5 Two circles of radii 16 cm and 4 cm, respectively, touch each other externally at Point A. PQ is the direct common tangent of these circles with centres  $C_1$  and  $C_2$ , respectively. What is the length of PQ?

- Ans
- 1. 15 cm
  - 2. 20 cm
  - 3. 16 cm
  - 4. 18 cm

Q.6 Study the given graph carefully and answer the question that follows. The graph shows the demand and production of different companies.

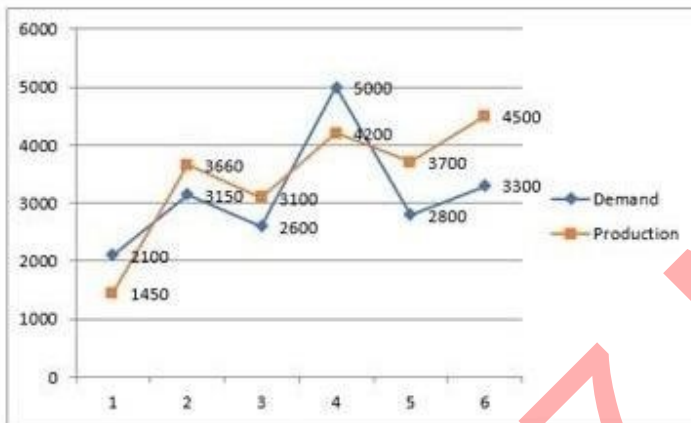

The ratio between the companies having more production than demand and more demand than the production is:

- Ans
- 1. 2 : 1
  - 2. 1 : 4
  - 3. 4 : 1
  - 4. 1 : 2

Q.7 An interval of 2 hours 25 minutes is wrongly estimated by 2 hours 30.5 minutes. The error percentage is:

- Ans
- 1.  $3\frac{23}{29}\%$
  - 2.  $2\frac{27}{29}\%$
  - 3.  $3\frac{19}{29}\%$
  - 4.  $2\frac{21}{29}\%$

Q.8 How many numbers between 10 and 65 are divisible by 2, 3 and 4?

- Ans
- 1. 3
  - 2. 7
  - 3. 9
  - 4. 5

Q.9 A shopkeeper charges his customer 14% more than the cost price. If a customer paid ₹18,240 for a mobile phone, then the cost price of the mobile phone was:

- Ans
- 1. ₹20,793.60
  - 2. ₹15,686.40
  - 3. ₹16,600
  - 4. ₹16,000

Q.10 The given pie-diagram shows the expenditure incurred on the preparation of a book by a publisher, under various heads. Study the pie-diagram and answer the question that follows.

Various Expenditures (in percentage) incurred in Publishing a Book

■ A-Paper ■ B-Printing ■ C-Binding ■ D-Royalty ■ E-Miscellaneous

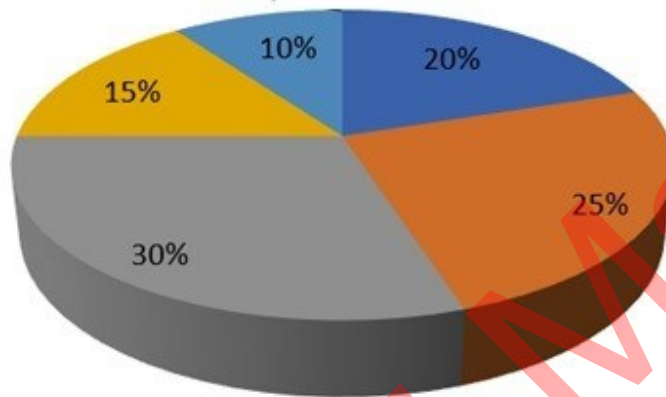

The marked price of a book is 20% more than the CP. If the marked price of the book is ₹30, then what is the cost of paper used in a single copy of the book?

- Ans
- 1. ₹5
  - 2. ₹4.50
  - 3. ₹6.50
  - 4. ₹6

Q.11 A father is presently 3 times his daughter's age. After 10 years he will be twice as old as her. Find the daughter's present age.

- Ans
- 1. 5 years
  - 2. 10 years
  - 3. 20 years
  - 4. 15 years

Q.12 The weights of the five friends are 67 kg, 85 kg, 70 kg, 90 kg, and 103 kg. Find the average of their weights in kg.

- Ans
- 1. 83
  - 2. 87
  - 3. 80
  - 4. 90

Q.13 In a triangle ABC, D and E are two points on sides AB and AC, respectively, such that DE is parallel to BC and AD : DB = 3 : 5. If AC = 5.6 cm, then find the value (in cm) of AE.

- Ans
- 1. 2.3
  - 2. 2.1
  - 3. 1.9
  - 4. 2.5

Q.14

If  $\cot A = \frac{5}{12}$ , then find the value of  $\frac{\sqrt{\sec A - \operatorname{cosec} A}}{\sqrt{\sec A + \operatorname{cosec} A}} - \sqrt{\frac{17}{7}}$ .

- Ans
- 1.  $\frac{24}{\sqrt{119}}$
  - 2. 0
  - 3.  $-\frac{10}{\sqrt{119}}$
  - 4.  $\frac{10}{\sqrt{119}}$

Q.15

The given table shows the number of entertainment shows (in hundreds) held in various cities. Study the table and answer the question that follows.

City	Entertainment Shows (in hundreds)				
	A	B	C	D	E
M	15	21	24	0.8	0.9
N	12.4	13	26	2	0.5
O	5.7	8	12	0.3	0.2
P	11.3	6	18	1	1.5
Q	17	12.4	11	3	0.4
R	14	10.5	9.8	0.7	0.1

What is the average number of entertainment shows held in city P?

- Ans
- 1. 766
  - 2. 756
  - 3. 750
  - 4. 700

Q.16 A solid sphere of radius 8 cm is melted and then recast into small spherical balls each of diameter 4 cm. Find the number of balls thus obtained (used  $\pi = \frac{22}{7}$ ).

- Ans
- 1. 48
  - 2. 64
  - 3. 24
  - 4. 32

Q.17 Antony and Julie can simultaneously complete a work of floor decoration in 15 days and Julie alone in 20 days. In how many days can Antony alone complete the work of floor decoration?

- Ans
- 1. 55
  - 2. 45
  - 3. 50
  - 4. 60

Q.18 If the radius of a sphere is increased by 5%, then by what percentage will the surface area of the sphere increase?

- Ans
- 1. 13.25%
  - 2. 11.25%
  - 3. 10.25%
  - 4. 15.25%

Q.19 Simplify the following expression.

$$4 \times 7 - 3 \{7 \times 4 \div (6 \times 2)\}$$

- Ans
- 1. 21
  - 2. 4
  - 3. 19
  - 4. 12

Q.20 The price of a car is decreased by 15% and 20% in two successive years respectively. What percentage of the price of the car is decreased after two years?

- Ans
- 1. 32%
  - 2. 25%
  - 3. 46%
  - 4. 15%

Q.21 A policeman is chasing a thief at a speed of 12 km/h, and the thief is running at a speed of 8 km/h. If the policeman started 30 minutes late, find the time taken by the policeman to catch the thief.

- Ans
- 1. 120 minutes
  - 2. 60 minutes
  - 3. 90 minutes
  - 4. 100 minutes

Q.22 The average of the areas of 2 similar triangles is  $706.5 \text{ m}^2$  whose perimeters are in the ratio of 6 : 11. What is 20% of the difference (in  $\text{m}^2$ ) in areas of both triangles?

- Ans
- 1. 157
  - 2. 149
  - 3. 153
  - 4. 164

Q.23 The perimeter of a rectangle is 70 cm and its diagonal is 25cm. The area of the rectangle is:

- Ans
- 1.  $425 \text{ cm}^2$
  - 2.  $300 \text{ cm}^2$
  - 3.  $625 \text{ cm}^2$
  - 4.  $420 \text{ cm}^2$

- Q.24 If the price of rice is reduced by 24%, it enables Alok to buy 10 kg more rice for ₹2,500. The reduced rate of rice per kg is:
- Ans  1. ₹25  
 2. ₹50  
 3. ₹60  
 4. ₹75

Q.25 Study the given pie-charts and answer the question that follows.

The pie-charts show the characteristics of foreign tourists visiting India during a given year.

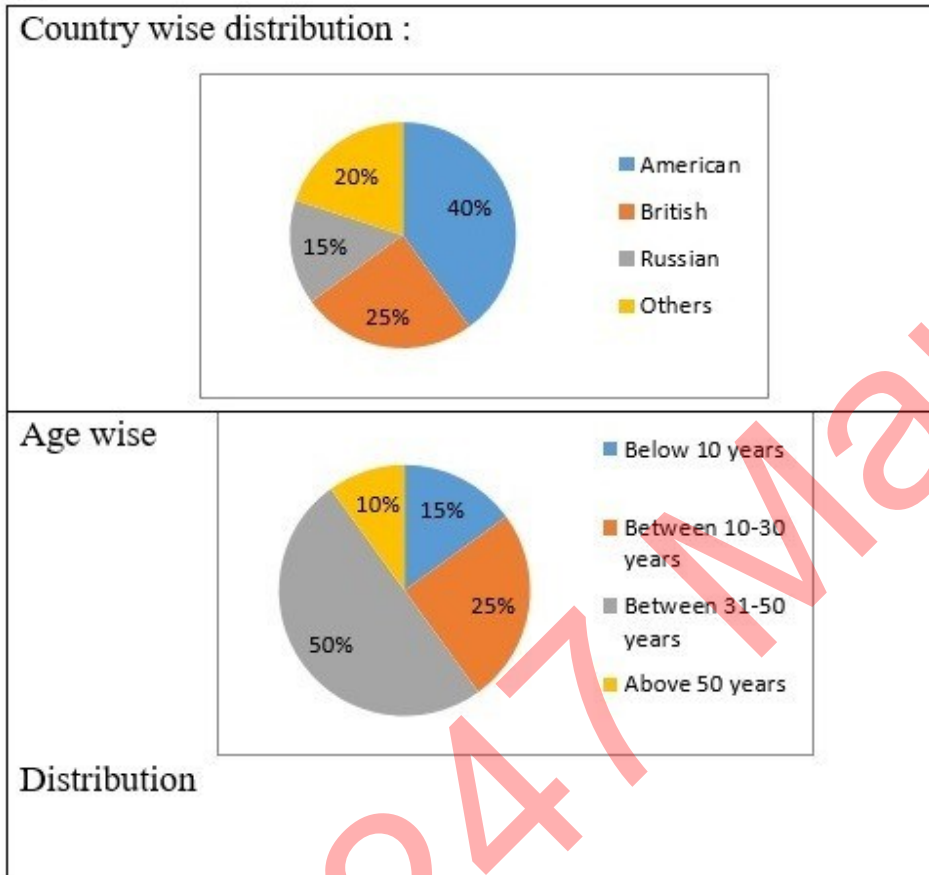

If in a given year, 2,50,000 tourists visited India and the age wise distribution of data applies to all the countries, then the number of Russian tourists who visited India during the year and were in the age group above 50 years is:

- Ans  1. 3,850  
 2. 385  
 3. 375  
 4. 3,750

Section : General Awareness

1. According to the census of India 2011, which state has the lowest population growth rate? Ans  1. Jharkhand  
 2. Punjab  
 3. Uttar Pradesh  
 4. Nagaland

2. In 2023, Praveen Chithravel won the men's triple jump event at the 'Prueba de Confrontacion' athletics meet held in \_\_\_\_\_.

- Ans
- 1. Canada
  - 2. Cuba
  - 3. Brazil
  - 4. Portugal

3. Which is the waterbody that separates Andaman Islands and Nicobar Islands?

- Ans
- 1. Eight Degree Channel
  - 2. Nine Degree Channel
  - 3. Ten Degree Channel
  - 4. Eleven Degree Channel

Q.4 According to the Census 2011 of India, which metropolitan has the second highest population?

- Ans
- 1. Kolkata
  - 2. Mumbai
  - 3. Chennai
  - 4. Delhi

Q.5 Which Article provides that all minorities have the right to establish and administer educational institutions of their choice?

- Ans
- 1. Article 26
  - 2. Article 24
  - 3. Article 32
  - 4. Article 30

Q.6 What is the IUPAC name of the compound  $\text{CH}_3\text{NH}_2$ ?

- Ans
- 1. Propan-1-amine
  - 2. Methanamine
  - 3. 2-Methyl propan-1-amine
  - 4. Ethanamine

Q.7 As of March, 2024, who is the minister of the Ministry of Cooperation, Government of India?

- Ans
- 1. Smriti Zubin Irani
  - 2. Amit Shah
  - 3. Dharmendra Pradhan
  - 4. Nitin Gadkari

Q.8 Which amongst the following statements is correct about Mughal emperor Akbar?

- Ans
- 1. He was declared emperor in 1602.
  - 2. He founded a new religion called 'Din-e Ilahi'.
  - 3. He was highly educated and knew many languages.
  - 4. He fought and won the third battle of Panipat against the Hindu King Hemu.

Q.9 Which of the following is an example of system software?

- Ans
- 1. Windows operating system
  - 2. Adobe Photoshop
  - 3. Microsoft Word
  - 4. Google Chrome



Q.10 What is the duration of single round in free style wrestling?

- Ans
- 1. 2 min
  - 2. 3.5 min
  - 3. 3 min
  - 4. 2.5 min

Q.11 Which of the following teams won the 9<sup>th</sup> Pro Kabaddi League 2022?

- Ans
- 1. Puneri Paltan
  - 2. Jaipur Pink Panthers
  - 3. Bengaluru Bulls
  - 4. UP Yoddhas

Q.12 Name the web portal launched by the Department of Telecommunication sharing information on mobile towers and EMF Emission Compliances.

- Ans
- 1. Bharat Net
  - 2. National Optical Fibre Network
  - 3. Tarang Sanchar
  - 4. Bharat Sanchar

Q.13 Which south-eastern Dravidian language has been approved by Odisha state to be included in the Eighth Schedule of the Constitution of India, on 10th July 2023?

- Ans
- 1. Tulu
  - 2. Kodagu
  - 3. Kui
  - 4. Malto

Q.14 Who was the first to develop a mathematical predictive heliocentric model of the solar system?

- Ans
- 1. Pierre-Simon Laplace
  - 2. Immanuel Kant
  - 3. Galileo Galilei
  - 4. Nicolaus Copernicus

Q.15 Brahma Samaj was earlier known as:

- Ans
- 1. Veda Samaj
  - 2. Prarthana Samaj
  - 3. Arya Samaj
  - 4. Bramho Sabha

Q.16 Which of the following committees recommended the inclusion of fundamental duties in the Constitution of India? Ans

- 1. Balwant Rai Mehta Committee
- 2. Sarkaria Committee
- 3. Swaran Singh Committee
- 4. Raja Mannar Committee

Q.17 What happens in case of market equilibrium:

- (a) Market demand = market supply
- (b) There is no excess supply in the market

- Ans
- 1. Neither (a) nor (b)
  - 2. Only (a)
  - 3. Both (a) and (b)
  - 4. Only (b)

Q.18 Bhavai is a dance form that belongs to which of the following states?

- Ans
- 1. Rajasthan
  - 2. Odisha
  - 3. Madhya Pradesh
  - 4. Bihar

Q.19 Mahavir Jayanti celebrates the birthday of Lord Mahavira who is the \_\_\_\_\_ Tirthankara of Jainism.

- Ans
- 1. 25<sup>th</sup>
  - 2. 26<sup>th</sup>
  - 3. 23<sup>rd</sup>
  - 4. 24<sup>th</sup>

Q.20 Which of the following causes enlargement and extension growth of cells?

- Ans
- 1. Imbibition
  - 2. Pressure potential
  - 3. Osmotic pressure
  - 4. Turgor pressure

Q.21 In July 2021, which of the following persons declared herself/himself brand ambassador of 'Khadi Prakritik Paint', made from cow dung by the Khadi and Village Industries Commission?

- Ans
- 1. Nitin Gadkari
  - 2. Nirmala Sitharaman
  - 3. Narendra Singh Tomar
  - 4. Rajnath Singh

Q.22 In which year was the Marris College of Music established in India?

- Ans
- 1. 1919
  - 2. 1901
  - 3. 1926
  - 4. 1922

Q.23 In MS Word, which option allows you to insert a new column in a table while simultaneously shifting the existing columns to the right?

- Ans
- 1. Insert Column to the Right
  - 2. Insert Columns
  - 3. Insert Table
  - 4. Insert Column to the Left

Q.24 Which of the following is NOT a part of Carnatic music?

- Ans
- 1. Varnam
  - 2. Dhrupad
  - 3. Pallavi
  - 4. Charana

Q.25

औद्योगिक नीति और संवर्धन विभाग के अनुसार निम्नलिखित में से कौन-सा एक प्रमुख उद्योग नहीं है?

Ans

✗ 1. बिजली

✓ 2. जूट

✗ 3. उर्वरक

✗ 4. कच्चा तेल

Adda247 Marathi

## Combined Higher Secondary Level Examination 2024 Tier I

Exam Date	08/07/2024
Exam Time	11:45 AM - 12:45 PM
Subject	CHSL Exam 2024 Tier I

### Section : English Language

1. Parts of the following sentence have been given as options. Select the option that contains an error. During winters, most of the trains are not running on time in North India.

Ans  1. During winters,  
 2. on time in North India.  
 3. are not running  
 4. most of the trains

2. The sentence below contains errors. Select the option with the correct use of tenses. I will revised my course at least three times before my final examination.

Ans  1. I would revised my course at least three times before my final examination.  
 2. I will be revised my course at least three times since my final examination.  
 3. I will have revised my course at least three times before my final examination.  
 4. I must revised my course at least three times before my final examination.

3. Select the most appropriate adverb to fill in the blank. He comes here \_\_\_\_\_.

Ans  1. quickly  
 2. formerly  
 3. daily  
 4. lately

- Q.4 Parts of the following sentence have been given as options. Select the option that contains an error.

That day we reached late for the competition and even though the competition went on smooth, I felt bad about Shivani losing it.

Ans  1. I felt bad  
 2. losing it  
 3. the competition went on smooth  
 4. we reached late

**Comprehension:**

In the following passage some words have been deleted. Fill in the blanks with the help of the alternatives given. Select the most appropriate option for each number.

Hierarchy is key in ensuring normal functioning of our increasingly (1)\_\_\_\_\_ society. In the US, there is an enormous variety of industries, professional branches, specialisations, as well as a great (2)\_\_\_\_\_ of other domains of human activity or interests. So, competence here is valued and opinion influencers have an important role to play. In fact, leadership evolves as a necessity almost in any realm of human activity/ thinking, (3)\_\_\_\_\_ where more people are involved. Thus, it isn't hard (4)\_\_\_\_\_ why even in academic institutions throughout the US and worldwide, students are given leadership essay assignments. Most students will take on leadership roles with various degrees of responsibility and impact in their lives, hence, becoming (5)\_\_\_\_\_ with typical challenges, solutions, or skills required is essential.

**SubQuestion No : 5****Q.5** Select the most appropriate option to fill in blank 1.

- Ans**
- 1. systematic
  - 2. complex
  - 3. easy
  - 4. fine

**Comprehension:**

In the following passage some words have been deleted. Fill in the blanks with the help of the alternatives given. Select the most appropriate option for each number.

Hierarchy is key in ensuring normal functioning of our increasingly (1)\_\_\_\_\_ society. In the US, there is an enormous variety of industries, professional branches, specialisations, as well as a great (2)\_\_\_\_\_ of other domains of human activity or interests. So, competence here is valued and opinion influencers have an important role to play. In fact, leadership evolves as a necessity almost in any realm of human activity/ thinking, (3)\_\_\_\_\_ where more people are involved. Thus, it isn't hard (4)\_\_\_\_\_ why even in academic institutions throughout the US and worldwide, students are given leadership essay assignments. Most students will take on leadership roles with various degrees of responsibility and impact in their lives, hence, becoming (5)\_\_\_\_\_ with typical challenges, solutions, or skills required is essential.

**SubQuestion No : 6****Q.6** Select the most appropriate option to fill in blank 2.

- Ans**
- 1. worry
  - 2. difficulty
  - 3. uniformity
  - 4. diversity

**Comprehension:**

In the following passage some words have been deleted. Fill in the blanks with the help of the alternatives given. Select the most appropriate option for each number.

Hierarchy is key in ensuring normal functioning of our increasingly (1)\_\_\_\_\_ society. In the US, there is an enormous variety of industries, professional branches, specialisations, as well as a great (2)\_\_\_\_\_ of other domains of human activity or interests. So, competence here is valued and opinion influencers have an important role to play. In fact, leadership evolves as a necessity almost in any realm of human activity/ thinking, (3)\_\_\_\_\_ where more people are involved. Thus, it isn't hard (4)\_\_\_\_\_ why even in academic institutions throughout the US and worldwide, students are given leadership essay assignments. Most students will take on leadership roles with various degrees of responsibility and impact in their lives, hence, becoming (5)\_\_\_\_\_ with typical challenges, solutions, or skills required is essential.

**SubQuestion No : 7****Q.7** Select the most appropriate option to fill in blank 3.

- Ans**
- 1. especially
  - 2. only
  - 3. easily
  - 4. tactfully

**Comprehension:**

In the following passage some words have been deleted. Fill in the blanks with the help of the alternatives given. Select the most appropriate option for each number.

Hierarchy is key in ensuring normal functioning of our increasingly (1)\_\_\_\_\_ society. In the US, there is an enormous variety of industries, professional branches, specialisations, as well as a great (2)\_\_\_\_\_ of other domains of human activity or interests. So, competence here is valued and opinion influencers have an important role to play. In fact, leadership evolves as a necessity almost in any realm of human activity/ thinking, (3)\_\_\_\_\_ where more people are involved. Thus, it isn't hard (4)\_\_\_\_\_ why even in academic institutions throughout the US and worldwide, students are given leadership essay assignments. Most students will take on leadership roles with various degrees of responsibility and impact in their lives, hence, becoming (5)\_\_\_\_\_ with typical challenges, solutions, or skills required is essential.

**SubQuestion No : 8****Q.8 Select the most appropriate option to fill in blank 4.**

- Ans
- 1. focusing
  - 2. rejecting
  - 3. polishing
  - 4. accepting

**Comprehension:**

In the following passage some words have been deleted. Fill in the blanks with the help of the alternatives given. Select the most appropriate option for each number.

Hierarchy is key in ensuring normal functioning of our increasingly (1)\_\_\_\_\_ society. In the US, there is an enormous variety of industries, professional branches, specialisations, as well as a great (2)\_\_\_\_\_ of other domains of human activity or interests. So, competence here is valued and opinion influencers have an important role to play. In fact, leadership evolves as a necessity almost in any realm of human activity/ thinking, (3)\_\_\_\_\_ where more people are involved. Thus, it isn't hard (4)\_\_\_\_\_ why even in academic institutions throughout the US and worldwide, students are given leadership essay assignments. Most students will take on leadership roles with various degrees of responsibility and impact in their lives, hence, becoming (5)\_\_\_\_\_ with typical challenges, solutions, or skills required is essential.

**SubQuestion No : 9****Q.9 Select the most appropriate option to fill in blank 5.**

- Ans
- 1. familiar
  - 2. unusual
  - 3. unequal
  - 4. strange

**Q.10 The following sentence has been split into four segments. Identify the segment that contains a grammatical error. Are today / a working day / or a / holiday?**

- Ans
- 1. Are today
  - 2. holiday
  - 3. a working day
  - 4. or a

**Q.11 Select the most appropriate option that can substitute the underlined segment in the given sentence. If there is no need to substitute it, select 'No substitution required'.  
They appointed him as the manager, as he was due for an promotion.**

- Ans
- 1. next
  - 2. it's
  - 3. No substitution required
  - 4. a

**Q.12 Choose an appropriate word that can substitute the bracketed word and complete the sentence meaningfully.  
What is the time (in) your watch?**

- Ans
- 1. by
  - 2. with
  - 3. into
  - 4. on

Q.13 Select the most appropriate ANTONYM of the underlined word in the given sentence.  
His grandfather was quite grumpy .

- Ans
- 1. Possible
  - 2. Tenable
  - 3. Edible
  - 4. Amiable

Q.14 Select the most appropriate ANTONYM of the underlined word.  
It's very cheap to display wealth by donning gaudy dresses.

- Ans
- 1. Scanty
  - 2. Ornate
  - 3. Cheap
  - 4. Sober

Q.15 Select the INCORRECTLY spelt word.

- Ans
- 1. Timorous
  - 2. Amalgamate
  - 3. Unintended
  - 4. Apropriate

Q.16 Select the most appropriate ANTONYM of the given word.  
MOROSE

- Ans
- 1. Jovial
  - 2. Practical
  - 3. Dramatic
  - 4. Hurried

Q.17 Select the most appropriate ANTONYM of the given word.  
Despondency

- Ans
- 1. Hopelessness
  - 2. Satisfaction
  - 3. Cheerfulness
  - 4. Dejection

Q.18 Select the most appropriate ANTONYM of the underlined word in the given sentence.  
The humble pupil sat on the floor with respect.

- Ans
- 1. Capitalist
  - 2. Corrupt
  - 3. Sturdy
  - 4. Proud

Q.19 Select the most appropriate meaning of the given idiom.  
Sell like hot cakes

- Ans
- 1. Extremely hot and humid
  - 2. Not bothering about money
  - 3. Selling out quickly
  - 4. Become very famous

Q.20 Select the most appropriate option to fill in the blank.

He hasn't \_\_\_\_\_ any attention to my miserable state.

- Ans
- 1. made
  - 2. had
  - 3. gave
  - 4. paid

Q.21 Select the most appropriate option that can substitute the underlined segment in the given sentence. If there is no need to substitute it, select 'No substitution required'.

She developing a remarkable resistance to cold and altitude.

- Ans
- 1. developed
  - 2. has develop
  - 3. No substitution required
  - 4. has been developing

Q.22 Which of the following idioms means 'going to sleep'?

- Ans
- 1. Keep an ear to the ground
  - 2. Run around in circles
  - 3. Break new grounds
  - 4. Hit the sack

Q.23 Select the INCORRECTLY spelt word.

- Ans
- 1. Creator
  - 2. Skewed
  - 3. Agressive
  - 4. Apparent

Q.24 Select the most appropriate synonym of the bracketed word in the following sentence to fill in the blank.

The setting sun turned the \_\_\_\_\_ (calm) ocean into a sea of gold.

- Ans
- 1. volatile
  - 2. placid
  - 3. furtive
  - 4. scattered

Q.25 Select the most appropriate synonym of the underlined word in the given sentence.

He is just jealous that he didn't get picked for the job.

- Ans
- 1. envious
  - 2. spiteful
  - 3. greedy
  - 4. suspicious

Section : General Intelligence

Q.1 What will come in the place of the question mark (?) in the following equation, if '+' and '×' are interchanged and '-' and '÷' are interchanged?

$$55 \times 84 - 12 + 9 \div 26 = ?$$

- Ans
- 1. 90
  - 2. 95
  - 3. 92
  - 4. 96



Q.2 Select the correct mirror image of the given figure when the mirror is placed at MN as shown below.

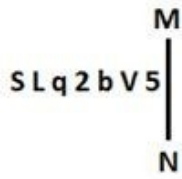

- Ans
- 1. 2VdSpJ2
  - 2. 5VdSpL2
  - 3. 2^dSpJ2
  - 4. 5VbSpJ2

3. After 36 days it will be a Sunday. What day is it today?

- Ans
- 1. Friday
  - 2. Monday
  - 3. Sunday
  - 4. Saturday

Q.4 If 'A' stands for '+', 'B' stands for 'x', 'C' stands for '+' and 'D' stands for '-', then the resultant of which of the following will be 338?

- Ans
- 1. 32 A 11 D 80 B 4 C 6
  - 2. 32 D 11 B 80 A 4 C 6
  - 3. 32 C 11 D 80 A 4 B 6
  - 4. 32 B 11 D 80 A 4 C 6

Q.5 In a certain code language,  
M & N means 'M is the son of N',  
M @ N means 'M is the brother of N',  
M \$ N means 'M is the father of N',  
M # N means 'M is the mother of N'.  
Based on this, how is E related to A, if 'A # B \$ C @ D & E'?

- Ans
- 1. Daughter's husband
  - 2. Son's wife
  - 3. Son
  - 4. Daughter

Q.6 Which of the following letter-clusters can replace the question mark (?) in the given series to make it logically complete?  
IPX, ?, OTZ, RVA, UXB

- Ans
- 1. LOM
  - 2. LRY
  - 3. YHR
  - 4. COP

Q.7 What would be the letter on the opposite side of 'N' if the given sheet is folded to form a cube?

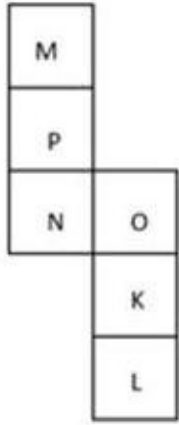

- Ans
- 1. O
  - 2. L
  - 3. M
  - 4. K

Q.8 This question consists of a pair of words which have a certain relationship to each other. Select the pair which does NOT have the same relationship.

Demolish : Repair

- 1) Condemn : Approve
- 2) Consequence : Outcome
- 3) Bind : Release
- 4) Adamant : Flexible

- Ans
- 1. 3
  - 2. 4
  - 3. 2
  - 4. 1

Q.9 Select the option in which the given figure is embedded (rotation is NOT allowed).

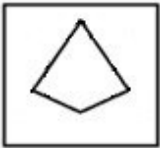

- Ans
- 1.
  - 2.
  - 3.
  - 4.

Q.10 Select the correct mirror image of the given figure when the mirror is placed at MN as shown below.



- Ans
- 1. YZRPWH
  - 2. WHPRZY
  - 3. WHPRNY
  - 4. YZRHWP

Q.11 Four letter-clusters have been given, out of which three are alike in some manner and one is different. Select the letter-cluster that is different.

(Note: The odd one out is not based on the number of consonants/vowels or their position in the letter cluster.)

- Ans
- 1. FUHS
  - 2. YCAZ
  - 3. AZCX
  - 4. MNOL

Q.12 Three statements are followed by conclusions numbered I, II. You have to consider these statements to be true, even if they seem to be at variance with commonly known facts. Decide which of the given conclusions logically follow/s from the given statement.

Statements:

Some roses are flowers.

All buds are roses.

All lilies are flowers.

Conclusion (I): Some buds are lilies.

Conclusion (II): All flowers are buds.

- Ans
- 1. Both conclusions (I) and (II) follow.
  - 2. Only conclusion (I) follows.
  - 3. Only conclusion (II) follows.
  - 4. Neither conclusion (I) nor (II) follows.

Q.13 27 is related to 3 following a certain logic. Following the same logic, 343 is related to 7. To which of the following is 1331 related following the same logic?

(NOTE : Operations should be performed on the whole numbers, without breaking down the numbers into its constituent digits. E.g. 13 – Operations on 13 such as adding /deleting /multiplying etc., to 13 can be performed. Breaking down 13 into 1 and 3 and then performing mathematical operations on 1 and 3 is not allowed.)

- Ans
- 1. 11
  - 2. 13
  - 3. 17
  - 4. 9

Q.14 Identify the figure given in the options which when put in place of ? will logically complete the series.

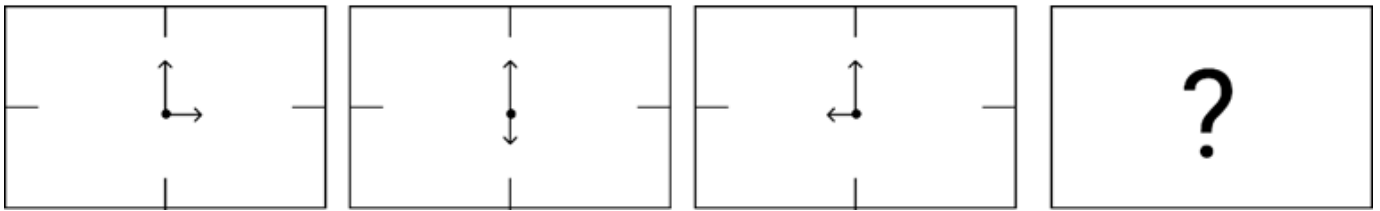

Ans

✓ 1.

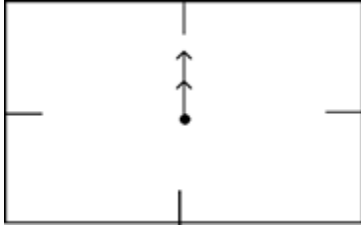

✗ 2.

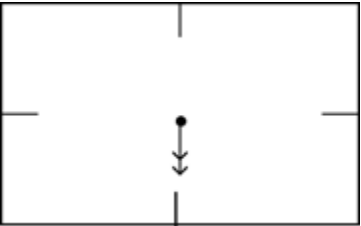

✗ 3.

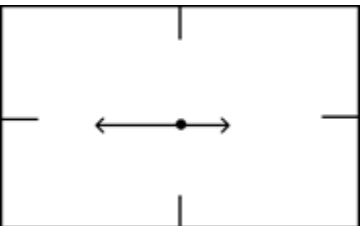

✗ 4.

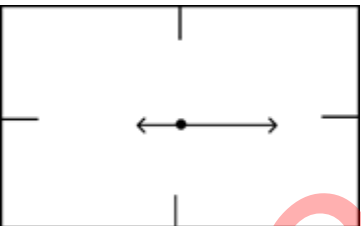

Q.15 If 11 November 2009 was Wednesday, then what was the day of the week on 17 November 2013?

Ans

✗ 1. Friday

✓ 2. Sunday

✗ 3. Saturday

✗ 4. Thursday

Q.16 What should come in place of the question mark (?) in the given series based on the English alphabetical order?  
XVS, AYV, DBY, GEB, ?

Ans

✗ 1. EJH

✗ 2. JEH

✗ 3. EHJ

✓ 4. JHE

Q.17 What should come in place of the question mark (?) in the given series?

77, 144, 278, 546, ?

Ans

✓ 1. 1082

✗ 2. 1028

✗ 3. 1208

✗ 4. 1802

Q.18 Which of the following numbers will replace the question mark (?) in the given series?

106, 106, 108, 36, 40, 8 ?

- Ans
- 1. 14
  - 2. 10
  - 3. 28
  - 4. 22

Q.19 Select the set in which the numbers are related in the same way as are the numbers of the following sets.

(59, 246, 23)

(68, 300, 32)

(NOTE : Operations should be performed on the whole numbers, without breaking down the numbers into its constituent digits. E.g. 13 – Operations on 13 such as adding /subtracting /multiplying etc., to 13 can be performed. Breaking down 13 into 1 and 3 and then performing mathematical operations on 1 and 3 is not allowed.)

- Ans
- 1. (32, 188, 71)
  - 2. (42, 213, 29)
  - 3. (31, 169, 53)
  - 4. (47, 248, 15)

Q.20 In a certain code language, 'FORK' is coded as '6851' and 'FROG' is coded as '5981'. How is 'K' coded in the given language?

- Ans
- 1. 1
  - 2. 5
  - 3. 9
  - 4. 6

Q.21 If 'A' stands for '+', 'B' stands for '×', 'C' stands for '÷' and 'D' stands for '−', what will come in place of the question mark (?) in the following equation?

91 B 2 D 22 A 11 C 8 = ?

- Ans
- 1. 188
  - 2. 128
  - 3. 148
  - 4. 168

Q.22 KLOQ is related to NORT in a certain way based on the English alphabetical order. In the same way, HILN is related to KLOQ. To which of the following is PQTV related, following the same logic?

- Ans
- 1. STWY
  - 2. SWTY
  - 3. SUVY
  - 4. STUY

Q.23 Select the option figure in which the given figure is embedded as its part (rotation is NOT allowed).



Ans

✗ 1.



✗ 2.



✗ 3.



✓ 4.

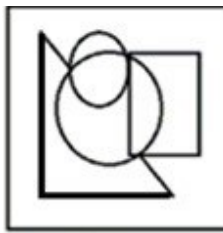

Q.24 How many triangles are there in the given figure?

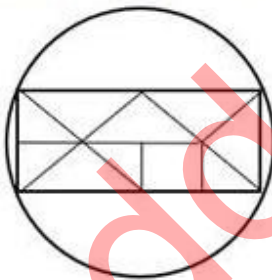

Ans

✗ 1. 10

✗ 2. 8

✓ 3. 14

✗ 4. 11

Q.25 What should come in place of ? in the given series?

281 392 503 614 725 ?

Ans

✗ 1. 846

✗ 2. 856

✗ 3. 866

✓ 4. 836

- Q.1** The given table represents the percentage marks of three students in three subjects. Study the table and answer the question.

subject Student	Geography	History	Economics
Rohan	78	77	74
Sohan	84	80	82
Mohan	87	83	86

The average marks obtain by Sohan in all three subject is equal to:

- Ans**
- 1. 78
  - 2. 80
  - 3. 82
  - 4. 84

- 2.** Two circles have radii of 27 cm and 36 cm. The distance between their centres is 45 cm. What is the length (in cm) of their common chord?

- Ans**
- 1. 37.2 cm
  - 2. 40.5 cm
  - 3. 43.2 cm
  - 4. 47.5 cm

- Q.3** When the integer  $n$  is divided by 5, the remainder is 3. What is the remainder if  $6n$  is divided by 5?

- Ans**
- 1. 2
  - 2. 1
  - 3. 3
  - 4. 0

Q.4 Study the given pie-chart and answer the question that follows.

The pie-chart represents the total number of valid votes obtained by four students who contested for school leadership. The total number of valid votes polled was 720.

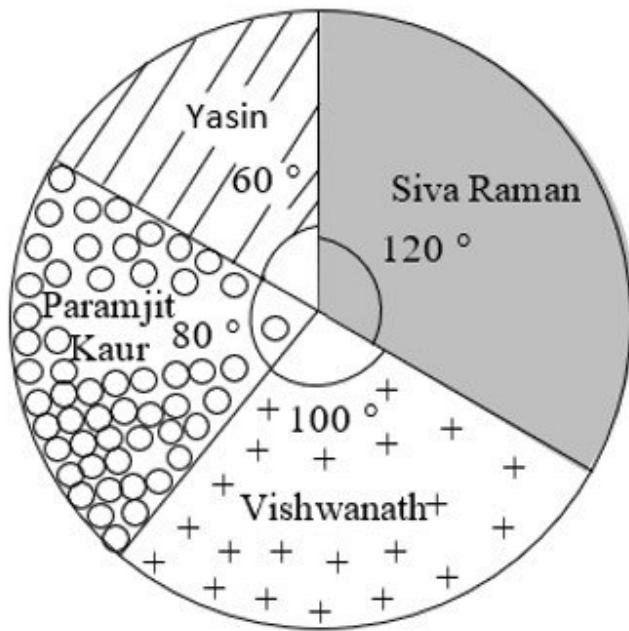

Who won the election?

- Ans
- 1. Yasin
  - 2. Vishwanath
  - 3. Siva Raman
  - 4. Paramjit Kaur

Q.5 The profit obtained by selling an article for ₹86 is twice the loss obtained by selling the same article for ₹53. Find the cost price.

- Ans
- 1. ₹33
  - 2. ₹22
  - 3. ₹64
  - 4. ₹75



Q.6

Study the given graph and answer the question that follows. The graph represents the depreciation of a car from 2001 to 2007.

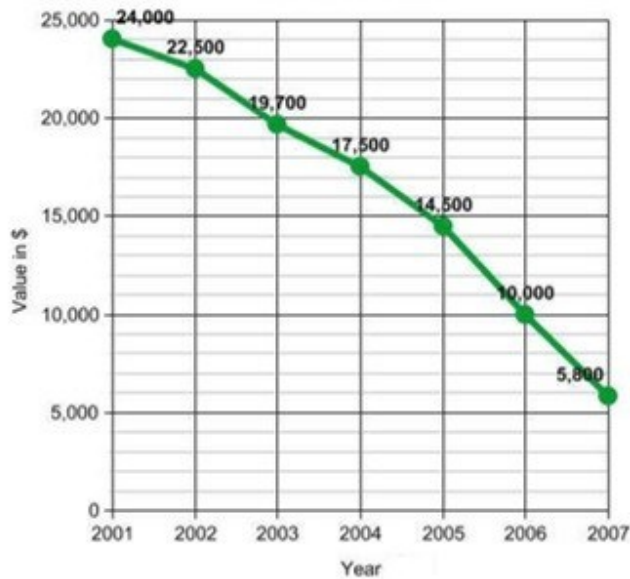

What is the depreciation of the car from 2001 to 2007 in percentage?

Ans

1. 62%  
 2. 81.32%  
 3. 75.83%  
 4. 58%

Q.7 The average of the first 10 natural numbers is \_\_\_\_\_

Ans

1. 5.5  
 2. 6.5  
 3. 5  
 4. 6

Q.8 A metallic solid cuboid of dimensions 36 cm × 22 cm × 12 cm is melted and recast in the form of cubes of side 6 cm. Find the number of the cubes so formed.

Ans

1. 46  
 2. 43  
 3. 45  
 4. 44

Q.9 To clear the old stock, Arshad offers a discount scheme to his customers - on buying 24 glass tumblers get 12 glass tumblers free. What is the effective percentage discount given by Arshad to his customers?

Ans

1.  $30\frac{1}{3}\%$   
 2.  $32\frac{2}{3}\%$   
 3.  $33\frac{1}{3}\%$   
 4.  $34\frac{2}{3}\%$

Q.10 Suresh studies the pattern of daily sale of a shop. He finds that on Monday, the sale was decreased by 10% in comparison to the sale on Sunday. On Tuesday, the sale was increased by 10% in comparison to the sale of Monday. If the sale on Tuesday was of ₹1,485, how much was the sale on Sunday?

- Ans
- 1. ₹1,495
  - 2. ₹1,475
  - 3. ₹1,485
  - 4. ₹1,500

Q.11 Identify a single-digit number other than 1, which may exactly divide the number  $17^3 + 18^3 - 16^3 - 15^3$ .

- Ans
- 1. 2
  - 2. 3
  - 3. 5
  - 4. 7

Q.12 If  $\tan(t) = \frac{3}{7}$ ,  $t$  is an acute angle, then what is the value of  $\operatorname{cosec}(t)$ ?

- Ans
- 1.  $\frac{\sqrt{53}}{7}$
  - 2.  $\frac{\sqrt{53}}{3}$
  - 3.  $\frac{\sqrt{58}}{3}$
  - 4.  $\frac{\sqrt{58}}{7}$

Q.13 Pranav gave 30% of the money he had to his wife, and 86% of the remaining to his two children. Half of the amount left was spent on other things, and the remaining amount of ₹98,000 was deposited in the bank. How much money did he have initially?

- Ans
- 1. ₹20,00,000
  - 2. ₹40,00,000
  - 3. ₹10,00,000
  - 4. ₹30,00,000

Q.14 What will be the amount due on ₹12,000 in 2 years when the rate of simple interest on successive years is 9% and 10%, respectively?

- Ans
- 1. ₹14,250
  - 2. ₹14,280
  - 3. ₹14,350
  - 4. ₹14,150

Q.15 If the radius of a sphere is increased by 3.5 cm, its surface area increases by  $550 \text{ cm}^2$ . What was the original radius of the sphere? (use  $\pi = \frac{22}{7}$ )

- Ans
- 1. 4.5 cm
  - 2. 3.5 cm
  - 3. 4 cm
  - 4. 6 cm

Q.16 ABC is a right-angled triangle, right angled at A in such a way that  $AB = AC$  and the bisector of angle B intersects the side AC at D. DM is perpendicular to BC, intersecting BC at M. If  $AB = 12$  cm and  $BC = 12\sqrt{2}$  cm, then find the length of side AD.

- Ans
- 1.  $12(\sqrt{2} + 2)$  cm
  - 2.  $12(\sqrt{2} - 2)$  cm
  - 3.  $12(\sqrt{2} - 1)$  cm
  - 4.  $12(\sqrt{2} + 1)$  cm

Q.17 Rohan takes 10 hours to mow a large lawn. He and Mohan together can mow it in 4 hours. How long will Mohan take to mow the lawn if he works alone?

- Ans
- 1.  $\frac{16}{3}$  hours
  - 2.  $\frac{20}{3}$  hours
  - 3.  $\frac{40}{3}$  hours
  - 4.  $\frac{10}{3}$  hours

Q.18 Two numbers are in the ratio 2:3. Their sum is 135. Find the numbers.

- Ans
- 1. 50, 85
  - 2. 60, 75
  - 3. 54, 81
  - 4. 45, 90

Q.19 A's income is equal to 125% of the income of B, while B's savings are 120% of the savings of A. If the expenditure of B is 75% of the expenditure of A, then how much are B's savings as a percentage of her expenditure?

- Ans
- 1. 20%
  - 2.  $22\frac{1}{2}\%$
  - 3.  $18\frac{3}{4}\%$
  - 4.  $16\frac{2}{3}\%$

Q.20 The ratio of the speeds of a boat while going upstream and going downstream is 2 : 3 and the sum of these two speeds is 15 km/h. What is the speed of the stream?

- Ans
- 1. 3.5 km/h
  - 2. 1.5 km/h
  - 3. 3 km/h
  - 4. 2.5 km/h

Q.21

The following line graph shows the ratio of imports to exports of two companies over the years. Study the graph carefully and answer the question that follows.

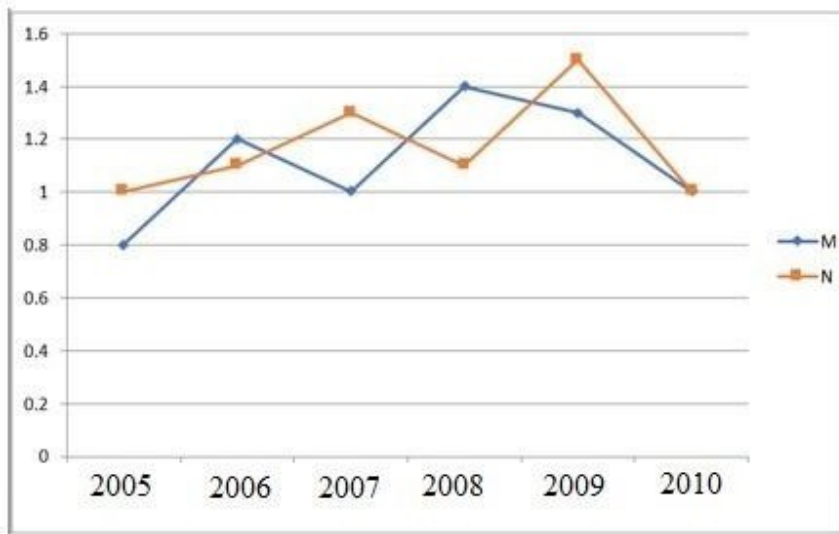

The exports of Company M with relation to imports was the maximum in which of the following years?

Ans



1. 2005



2. 2009



3. 2008



4. 2006

Q.22 A two-digit number is 12 more than five times the sum of its digits. The number formed by reversing the digits is 9 less than the original number. The number is:

Ans



1. 96



2. 78



3. 69



4. 87

Q.23 The length of a common external tangent to two circles of an equal radius of 5 units is equal to the diameter of the circle. Which of the following can be the distance between the centres of the circles in units?

Ans



1. 10



2. 12



3. 9



4. 8

Q.24 X and Y are two points on the circumference of a circle having diameter 20 cm. The length of the line segment XY is 16 cm. Find the distance (in cm) of the line segment XY from the centre of the circle.

Ans



1. 6



2. 3



3. 5



4. 4

Q.25 The perimeter of a square whose area is the same as the area of a semi-circle of radius  $2\sqrt{2}$  cm is:

Ans

1.  $4\sqrt{\pi}$  cm

2.  $16\sqrt{\pi}$  cm

3.  $8\sqrt{2\pi}$  cm

4.  $8\sqrt{\pi}$  cm

Section : General Awareness

1. The Government of India's Ministry of Culture organised a programme called Vitasta in January 2023. This programme exhibits rich culture, arts and crafts of which region?

Ans

1. Himachal

2. Punjab

3. Kashmir

4. Ladakh

2. Who founded a reformist organisation called 'Brahmo Samaj' in Calcutta?

Ans

1. Vinoba Bhave

2. Raja Ram Mohan Roy

3. Ishwar Chandra Vidyasagar

4. Jyotiba Phule

3. Which state organises the Lokrang Festival?

Ans

1. Arunachal Pradesh

2. Uttar Pradesh

3. Himachal Pradesh

4. Madhya Pradesh

Q.4 'Pankhida' songs are sung by peasants of \_\_\_\_\_ while working on the fields.

Ans

1. Odisha

2. Bihar

3. Rajasthan

4. Uttar Pradesh

Q.5 Which cost is considered for calculating the national income in India?

Ans

1. Factor cost

2. Product cost

3. Market cost

4. Sunk cost

Q.6 Which of the following organisation's initiative is 'India Justice Report'?

Ans

1. Tata Trusts

2. Azim Premji Foundation

3. Infosys Foundation

4. HCL Foundation

Q.7 Which of the following is an input device?

- Ans
- 1. Speaker
  - 2. Monitor
  - 3. Printer
  - 4. Keyboard

Q.8 Western disturbances are responsible for:

- Ans
- 1. extremely chilled weather of north-east India
  - 2. dusty storms in eastern coastal area of India
  - 3. rainfall during winters in north-western part of India
  - 4. hot winds during summers in northern India

Q.9 Which type of electromagnetic radiation was discovered by Johann Wilhelm Ritter in 1801?

- Ans
- 1. X-rays
  - 2. Ultraviolet rays
  - 3. Infrared rays
  - 4. Gamma rays

Q.10 Indian Railway was introduced in the year \_\_\_\_\_.

- Ans
- 1. 1852
  - 2. 1851
  - 3. 1853
  - 4. 1850

Q.11 Which of the following statements is/are true with respect to MRTP Act?

- i) The Monopolies and Restrictive Trade Practices Act (MRTP Act) was repealed and replaced by the Competition Act, 2002.
- ii) The asset limit for MRTP companies was fixed at Rs. 25 crores by the first/original Monopolies and Restrictive Trade Practices Act (MRTP Act).
- iii) The Monopolies and Restrictive Trade Practices Act (MRTP Act) was first passed in 1969.

- Ans
- 1. Only i and iii
  - 2. Only ii and iii
  - 3. Only iii
  - 4. Only i and ii

Q.12 \_\_\_\_\_ is a musical composition that expresses devotion through madhura bhakti.

- Ans
- 1. Tillana
  - 2. Padam
  - 3. Gita
  - 4. Kirti

Q.13 Which state secured over all third position in the medals tally at the 36<sup>th</sup> National Games (2022) of India?

- Ans
- 1. Haryana
  - 2. Delhi
  - 3. Kerala
  - 4. Maharashtra

Q.14 In the 11th century, under Maḥmūd of Ghazni, Ghaznī, a small town in \_\_\_\_\_, became the capital of the vast empire of the Ghaznavids.

- Ans
- 1. Turkey
  - 2. Egypt
  - 3. Persia
  - 4. Afghanistan

Q.15 Which set of Articles in the Constitution of India are known as 'Cultural and Educational Rights'?

- Ans
- 1. Articles 19-20
  - 2. Articles 29-30
  - 3. Articles 14-15
  - 4. Articles 23-24

Q.16 In which of the following regions of India is the Mundari language spoken?

- Ans
- 1. Malwa plateau
  - 2. Thar desert
  - 3. Chota-Nagpur plateau
  - 4. Baghelkhand

Q.17 Pandit Birju Maharaj was related to:

- Ans
- 1. Ozele
  - 2. Kathak
  - 3. Odissi
  - 4. Tapu

Q.18 A school teacher asks students to stand up every time national anthem is sung. Which Article enshrines this fundamental duty?

- Ans
- 1. Article 51 (d)
  - 2. Article 51 (c)
  - 3. Article 51 (b)
  - 4. Article 51A (a)

Q.19 In which year did the Indian football team go on its first known official international tour?

- Ans
- 1. 1947
  - 2. 1914
  - 3. 1950
  - 4. 1924

Q.20 Why is the six membered cyclic structure of glucose called a pyranose structure?

- Ans
- 1. Pyran is a non-cyclic organic compound, with one oxygen atom and five carbon atoms in the ring.
  - 2. Pyran is a cyclic organic compound, with one oxygen atom and five carbon atoms in the ring.
  - 3. Furan is a five membered non-cyclic compound, with one oxygen and four carbon atoms.
  - 4. Furan is a five membered cyclic compound, with one oxygen and four carbon atoms.

Q.21 When a new text document is created in MS-Office 2016, the default text size of the document is \_\_\_\_\_.

- Ans
- 1. 10 points
  - 2. 14 points
  - 3. 12 points
  - 4. 11 points

**Q.22** Recently, a bill on Uniform Civil Code (UCC) was introduced. Consider the following statements about UCC and identify the correct statement(s) from them.

1. The Uniform Civil Code in India Bill, 2020, was introduced in the Lok Sabha as a private member bill.
2. UCC refers to the same set of civil laws applicable to all the citizens of India in all the personal matters.
3. The provision for UCC in the Constitution of India is mentioned under Article 44.

- Ans**
- 1. Only 1
  - 2. Only 1 and 3
  - 3. Only 2 and 3
  - 4. Only 3

**Q.23** According to the National Multidimensional poverty index 2021, which of the following states has the lowest percentage of population being multidimensional poor?

- Ans**
- 1. Maharashtra
  - 2. Punjab
  - 3. Sikkim
  - 4. Bihar

**Q.24** India is home to the second oldest cricket club in the world. Where is it situated?

- Ans**
- 1. Kolkata
  - 2. Chennai
  - 3. Mumbai
  - 4. Hyderabad

**Q.25** Which of the following types of crops are sown at the beginning of the monsoon season?

- Ans**
- 1. Zaid crops
  - 2. Rabi crops
  - 3. Vital crops
  - 4. Kharif crops



## Combined Higher Secondary Level Examination 2024 Tier I

Exam Date	08/07/2024
Exam Time	2:30 PM - 3:30 PM
Subject	CHSL Exam 2024 Tier I

### Section : English Language

1. The following sentence has been split into four segments. Identify the segment that contains an error. In this cold weather, / there's nothing / like good / cup of coffee.

- Ans
- 1. In this cold weather
  - 2. like good
  - 3. cup of coffee
  - 4. there's nothing

2. The given sentence is divided into four segments. Select the option that has the segment with a grammatical error. The general's address / was applauds / by all sections / of society.

- Ans
- 1. by all sections
  - 2. was applauds
  - 3. of society.
  - 4. the general's address

3. Parts of the following sentence have been given as options. Select the option that contains an error. There's an quiet street down the left that you can use for your dance practice.

- Ans
- 1. down the left
  - 2. that you can use
  - 3. There's an quiet street
  - 4. for your dance practice

Q.4 The given sentence is divided into four segments. Select the option that has the segment with a grammatical error. A part / of an / apple is / rotten.

- Ans
- 1. apple is
  - 2. of an
  - 3. A part
  - 4. rotten.

**Comprehension:**

In the following passage, some words have been deleted. Read the passage carefully and select the most appropriate option to fill in each blank.

Trees provide so many benefits (1)\_\_\_\_\_our everyday lives. They filter clean air, provide fresh drinking water, help (2)\_\_\_\_\_climate change and create homes for thousands of species of plants and animals. (3)\_\_\_\_\_a billion trees can help save the Earth from climate change and biodiversity loss. When we restore and (4)\_\_\_\_\_critical forests, we remove carbon and support biodiversity. A billion is a big number, but we know we can do it together. (5)\_\_\_\_\_the planet by planting your tree today. This can protect and restore forests for future.

**SubQuestion No : 5****Q.5 Select the most appropriate option to fill in blank number 1.**

- Ans**
- 1. in
  - 2. to
  - 3. for
  - 4. with

**Comprehension:**

In the following passage, some words have been deleted. Read the passage carefully and select the most appropriate option to fill in each blank.

Trees provide so many benefits (1)\_\_\_\_\_our everyday lives. They filter clean air, provide fresh drinking water, help (2)\_\_\_\_\_climate change and create homes for thousands of species of plants and animals. (3)\_\_\_\_\_a billion trees can help save the Earth from climate change and biodiversity loss. When we restore and (4)\_\_\_\_\_critical forests, we remove carbon and support biodiversity. A billion is a big number, but we know we can do it together. (5)\_\_\_\_\_the planet by planting your tree today. This can protect and restore forests for future.

**SubQuestion No : 6****Q.6 Select the most appropriate option to fill in blank number 2.**

- Ans**
- 1. crib
  - 2. cut
  - 3. curb
  - 4. crust

**Comprehension:**

In the following passage, some words have been deleted. Read the passage carefully and select the most appropriate option to fill in each blank.

Trees provide so many benefits (1)\_\_\_\_\_our everyday lives. They filter clean air, provide fresh drinking water, help (2)\_\_\_\_\_climate change and create homes for thousands of species of plants and animals. (3)\_\_\_\_\_a billion trees can help save the Earth from climate change and biodiversity loss. When we restore and (4)\_\_\_\_\_critical forests, we remove carbon and support biodiversity. A billion is a big number, but we know we can do it together. (5)\_\_\_\_\_the planet by planting your tree today. This can protect and restore forests for future.

**SubQuestion No : 7****Q.7 Select the most appropriate option to fill in blank number 3.**

- Ans**
- 1. In planting
  - 2. With planting
  - 3. By planting
  - 4. Planting

**Comprehension:**

In the following passage, some words have been deleted. Read the passage carefully and select the most appropriate option to fill in each blank.

Trees provide so many benefits (1)\_\_\_\_\_our everyday lives. They filter clean air, provide fresh drinking water, help (2)\_\_\_\_\_climate change and create homes for thousands of species of plants and animals. (3)\_\_\_\_\_a billion trees can help save the Earth from climate change and biodiversity loss. When we restore and (4)\_\_\_\_\_critical forests, we remove carbon and support biodiversity. A billion is a big number, but we know we can do it together. (5)\_\_\_\_\_the planet by planting your tree today. This can protect and restore forests for future.

**SubQuestion No : 8****Q.8 Select the most appropriate option to fill in blank number 4.**

- Ans**
- 1. sabotage
  - 2. conserve
  - 3. observe
  - 4. curtail

**Comprehension:**

In the following passage, some words have been deleted. Read the passage carefully and select the most appropriate option to fill in each blank.

Trees provide so many benefits (1)\_\_\_\_\_our everyday lives. They filter clean air, provide fresh drinking water, help (2)\_\_\_\_\_climate change and create homes for thousands of species of plants and animals. (3)\_\_\_\_\_a billion trees can help save the Earth from climate change and biodiversity loss. When we restore and (4)\_\_\_\_\_critical forests, we remove carbon and support biodiversity. A billion is a big number, but we know we can do it together. (5)\_\_\_\_\_the planet by planting your tree today. This can protect and restore forests for future.

**SubQuestion No : 9**

**Q.9** Select the most appropriate option to fill in blank number 5.

- Ans
- 1. Denigrate
  - 2. Complement
  - 3. Sustain
  - 4. Supplement

**Q.10** Select the most appropriate option that can substitute the underlined segment in the given sentence.

He has grown into a beautiful youth.

- Ans
- 1. in a beautiful youth
  - 2. a beautiful youth
  - 3. in a handsome youth
  - 4. into a handsome youth

**Q.11** Select the most appropriate synonym of the given word.  
Venom

- Ans
- 1. Poison
  - 2. Butter
  - 3. Fruit juice
  - 4. Honey

**Q.12** Select the most appropriate option that can substitute the underlined segment in the given sentence. If there is no need to substitute it, select 'No substitution required'.

The inspector smile after he was finished and patted Margie's head.

- Ans
- 1. No substitution required
  - 2. smiled
  - 3. was smiled
  - 4. has smiled

**Q.13** Select the most appropriate option to substitute the underlined segment in the following sentence.

Rohit is write to them three times.

- Ans
- 1. Rohit was beings written
  - 2. Rohit was write
  - 3. Rohit had write
  - 4. Rohit has written

**Q.14** Select the most appropriate meaning of the given idiom.

Where the shoe pinches

- Ans
- 1. Unknown paths
  - 2. Difficult roads
  - 3. Where the difficulty lies
  - 4. Where the shoe hurts

Q.15 Select the most appropriate synonym of the given word.  
Callous

- Ans
- 1. Cruel
  - 2. Generous
  - 3. Affectionate
  - 4. Exhausting

Q.16 Select the most appropriate ANTONYM of the underlined word in the given sentence.  
The CEO called for compulsory participation from each employee.

- Ans
- 1. Voluntary
  - 2. Compliantly
  - 3. Obligatory
  - 4. Overtly

Q.17 Select the most appropriate synonym of the given word.

Baffle

- Ans
- 1. Explicate
  - 2. Confuse
  - 3. Barbarous
  - 4. Equalise

Q.18 Select the most appropriate ANTONYM of the given word.  
Logical

- Ans
- 1. Subtle
  - 2. Random
  - 3. Reasonable
  - 4. Illogical

Q.19 Select the most appropriate option to fill in the blank.  
The company's \_\_\_\_\_ commitment to sustainability is admirable.

- Ans
- 1. shakeable
  - 2. resolute
  - 3. wavering
  - 4. strong

Q.20 The given sentence is divided into four segments. Identify the segment that contains a spelling error. To submit a report / on the recent fire accident, / a high level committee / has been formed.

- Ans
- 1. To submit a report
  - 2. has been formed
  - 3. on the recent fire accident
  - 4. a high level committee

Q.21 Select the most appropriate idiom to fill in the blank.  
Mala \_\_\_\_\_ by cheating on the exam to win her bet with Priya.

- Ans
- 1. get the sack
  - 2. look down upon
  - 3. hit below the belt
  - 4. fell out

Q.22 Identify the INCORRECTLY spelt word in the following sentence and select the option with the correct spelling.

Stomach sleepers were rated as being more gregairious and uncomfortable with criticism.

- Ans
- 1. gregarious
  - 2. criticicm
  - 3. ratedd
  - 4. stomac

Q.23 Select the most appropriate option to substitute the underlined segment in the following sentence.  
We are decorate the living-room at the moment.

- Ans
- 1. We are being decorating
  - 2. We are being decorate
  - 3. We are decorates
  - 4. We are decorating

Q.24 Select the most appropriate option to fill in the blank.

The perfume she uses has a strong \_\_\_\_\_.

- Ans
- 1. sent
  - 2. scent
  - 3. cent
  - 4. send

Q.25 Select the most appropriate option to fill in the blank.  
Rosy and Nicky couldn't provide any evidence to support \_\_\_\_\_ arguments.

- Ans
- 1. there
  - 2. theirs
  - 3. their
  - 4. they're

Section : General Intelligence

Q.1 Select the correct mirror image of the given figure when the mirror is placed at MN.

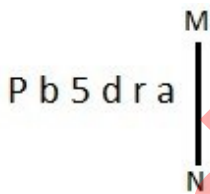

- Ans
- 1. P b 5 d r a
  - 2. P b 5 d r a
  - 3. P b 5 d r a
  - 4. a r b 5 d P

2. 'A × B' means 'A is B's mother'.  
'A ÷ B' means 'A is B's son'.  
'A + B' means 'A is B's husband'.  
'A - B' means 'A is B's sister'.

Using the same meaning of the mathematical operators as given above, in 'D + E × F - G' what is the relation of F with D?

- Ans
- 1. Sister's daughter
  - 2. Mother
  - 3. Son
  - 4. Daughter

Q.3 What will come in the place of the question mark (?) in the following equation, if '+' and '-' are interchanged and '×' and '÷' are interchanged?

$$61 + 80 - 48 \times 3 \div 5 = ?$$

- Ans
- 1. 60
  - 2. 63
  - 3. 62
  - 4. 61

Q.4 TOWB is related to CVDU in a certain way based on the English alphabetical order. In the same way, VKFA is related to BRMW. To which of the following is CMZU related, following the same logic?

- Ans
- 1. VGTD
  - 2. VGDT
  - 3. VTGD
  - 4. VTDG

Q.5 Which of the following numbers will replace the question mark (?) in the given series?

454 515 426 481 398 447 370 413 ?

- Ans
- 1. 313
  - 2. 326
  - 3. 342
  - 4. 354

Q.6 What should come in place of the question mark (?) in the given series?

12, 16, 25, 41, 66, ?

- Ans
- 1. 104
  - 2. 101
  - 3. 103
  - 4. 102

Q.7 Select the combination of letters that when sequentially placed in the blanks of the given series will complete the series.

ZY\_WZTX\_Z\_XU\_JXT

- Ans
- 1. ZYOX
  - 2. YVOZ
  - 3. XOYZ
  - 4. XVOZ

Q.8 Select the correct mirror image of the given figure when the mirror is placed at MN as shown below.

QZGSIN

- Ans
- 1. NIGSSQ
  - 2. NISGSQ
  - 3. NISGSSQ
  - 4. NISGSQZ

Q.9 In a certain code language, 'WYNK' is coded as '9243' and 'YAWN' is coded as '3941'. How is 'A' coded in the given language?

- Ans
- 1. 2
  - 2. 9
  - 3. 3
  - 4. 1

Q.10 Select the correct mirror image of the given figure when the mirror is placed at MN as shown below.



- Ans
- 1. a b p 3 d R j
  - 2. a b p 3 d R j
  - 3. j R p 3 4 d a
  - 4. j R p 3 4 d a

Q.11 Three statements are followed by conclusions numbered I, II. You have to consider these statements to be true, even if they seem to be at variance with commonly known facts. Decide which of the given conclusions logically follow/s from the given statement.

Statements:

Some rivers are huts.

All streams are grass.

Some grass are rivers.

Conclusion (I): All grass are streams.

Conclusion (II): Some grass are huts.

- Ans
- 1. Only conclusion (I) follows.
  - 2. Only conclusion (II) follows.
  - 3. Neither conclusion (I) nor (II) follows.
  - 4. Both conclusions (I) and (II) follow.

Q.12 Which letter-cluster will replace the question mark (?) to complete the given series?  
KLHO, LKIN, ?, QFNI, UBRE

- Ans
- 1. OJKL
  - 2. NIKL
  - 3. NJKM
  - 4. OIKM

Q.13 If 05 August 2005 is Friday, then what will be the day of the week on 17 April 2011?

- Ans
- 1. Saturday
  - 2. Wednesday
  - 3. Sunday
  - 4. Monday

Q.14 13 is related to 39 following a certain logic. Following the same logic, 25 is related to 75. To which of the following is 42 related following the same logic?  
 (NOTE : Operations should be performed on the whole numbers, without breaking down the numbers into its constituent digits. E.g. 13 – Operations on 13 such as adding /deleting /multiplying etc., to 13 can be performed. Breaking down 13 into 1 and 3 and then performing mathematical operations on 1 and 3 is not allowed.)

- Ans
- 1. 128
  - 2. 126
  - 3. 118
  - 4. 120

Q.15 Identify the figure in the options that when put in place of the question mark (?) will logically complete the series?

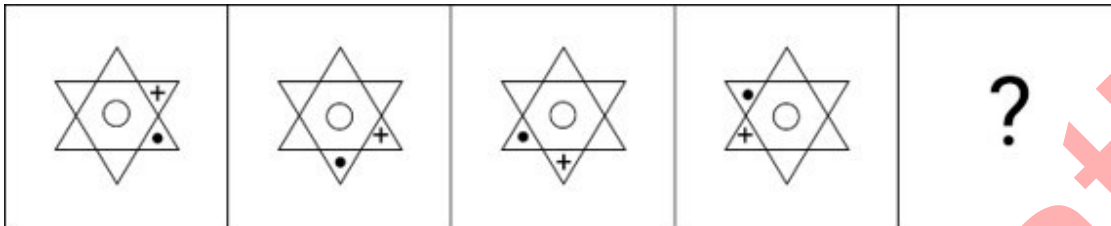

Ans

- 1.
- 2.
- 3.
- 4.

Q.16 Each of the letters in the word TRAMPOLINE are arranged from left to right in alphabetical order to form a new word. How many letters are there in the English alphabetical series between the alphabet which is fourth from the left and the one which is first from the right in the newly formed word?

- Ans
- 1. Five
  - 2. Four
  - 3. Six
  - 4. Seven



Q.17 How many triangles are there in the given figure?

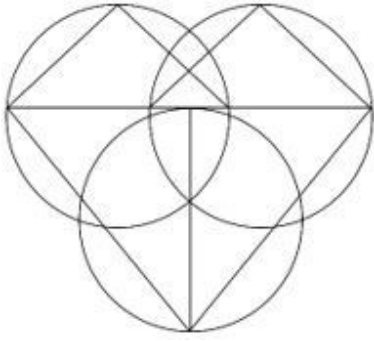

- Ans
- 1. 7
  - 2. 8
  - 3. 5
  - 4. 6

Q.18 What will come in the place of the question mark (?) in the following equation, if '+' and '×' are interchanged and '-' and '÷' are interchanged?

$$35 \times 16 + 3 \div 156 - 12 = ?$$

- Ans
- 1. 70
  - 2. 63
  - 3. 64
  - 4. 72

Q.19 'YPCLY' is related to 'RIVER' in a certain way based on the English alphabetical order. In the same way, 'ZWHJL' is related to 'SPACE'. To which of the following is 'TVJRALZA' related, following the same logic?

- Ans
- 1. MOXKTEST
  - 2. MOOKTEST
  - 3. MOCTTEST
  - 4. MOCKTEST

Q.20 Select the option figure in which the given figure (X) is embedded as its part (rotation is NOT allowed).

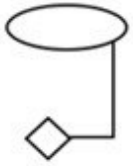

(X)

Ans

✗ 1.

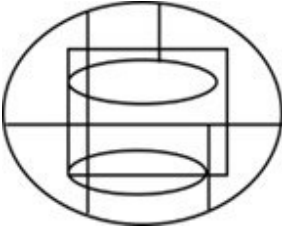

✓ 2.

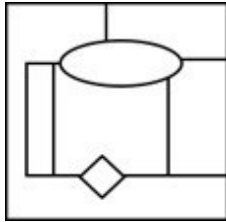

✗ 3.

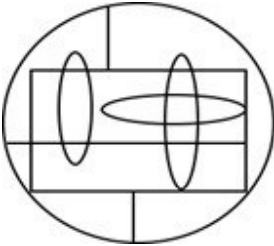

✗ 4.

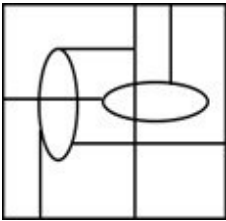

Adda247 Marathi

Q.21 Select the option in which the given figure X is embedded (i.e. contains figure X in the same form).

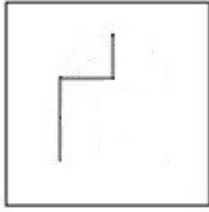

(X)

Ans

✗ 1.

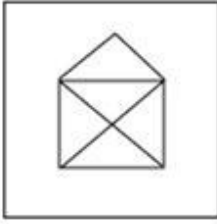

✗ 2.

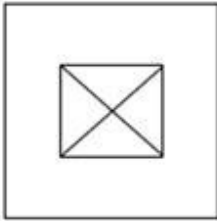

✓ 3.

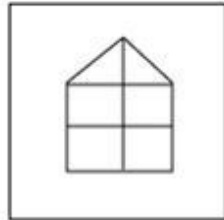

✗ 4.

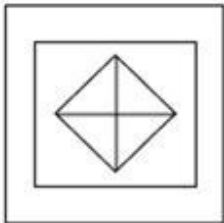

Q.22 While introducing Madhav, Jihaan said, "I am the only son of one the sons of his mother."  
How is Madhav related to Jihaan?

Ans ✓ 1. Father or paternal uncle

✗ 2. Son or brother

✗ 3. Cousin

✗ 4. Maternal nephew or paternal nephew

Q.23 If 'A' stands for '+', 'B' stands for '×', 'C' stands for '÷' and 'D' stands for '-', what will come in place of the question mark (?) in the following equation?

$$45 \text{ B } 6 \text{ D } 78 \text{ A } 3 \text{ C } 15 = ?$$

Ans ✗ 1. 256

✗ 2. 257

✓ 3. 259

✗ 4. 258

- Q.24 In a certain code language, 'power' is coded as '45978' and 'rain' is coded as '7312'. How is 'r' coded in that language?
- Ans  1. 1  
 2. 7  
 3. 3  
 4. 5

- Q.25 Select the set in which the numbers are related in the same way as are the numbers of the following sets.  
 (NOTE: Operations should be performed on the whole numbers, without breaking down the numbers into its constituent digits. E.g. 13 – Operations on 13 such as adding/subtracting/multiplying etc. to 13 can be performed. Breaking down 13 into 1 and 3 and then performing mathematical operations on 1 and 3 is not allowed.)  
 (75, 89, 103)  
 (98, 112, 126)
- Ans  1. (95, 109, 118)  
 2. (87, 101, 125)  
 3. (82, 96, 110)  
 4. (72, 91, 105)

Section : Quantitative Aptitude

- Q.1 Study the given graph carefully and answer the question that follows. The graph shows the demand and production of different companies.

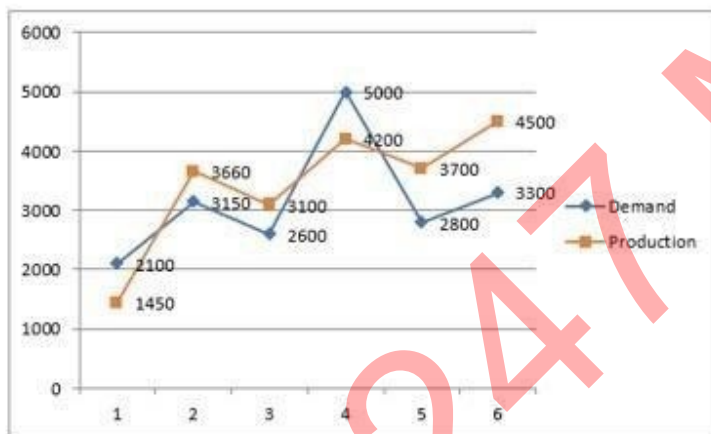

Lowest production is what percentage of the highest demand?

- Ans  1. 71%  
 2. 70%  
 3. 29%  
 4. 30%

- Q.2 Pradeep sells two fans at ₹480 each and by doing so he gains 20% on one fan and loses 20% on the other. His loss on the whole (in ₹) is:

- Ans  1. 30  
 2. 10  
 3. 20  
 4. 40

- Q.3 The area of an isosceles right angled triangle is  $16 \text{ m}^2$ . Its hypotenuse is \_\_\_\_\_.

- Ans  1. 0.8 m  
 2. 4 m  
 3. 8 cm  
 4. 8 m

Q.4 8 apples and 10 oranges weigh 5 kg. 12 apples and 20 oranges weigh 9 kg. What is the weight (in kg, rounded off to the nearest integer) of 15 apples and 24 oranges?

- Ans
- 1. 13
  - 2. 10
  - 3. 16
  - 4. 11

Q.5 Simplify

$$4\frac{1}{4} \times 4\frac{1}{4} - 2 \times 4\frac{1}{4} \times \frac{1}{4} + \frac{1}{4} \times \frac{1}{4}$$

- Ans
- 1. 64
  - 2. 32
  - 3. 4
  - 4. 16

Q.6 Study the given bar-graph and answer the question that follows.

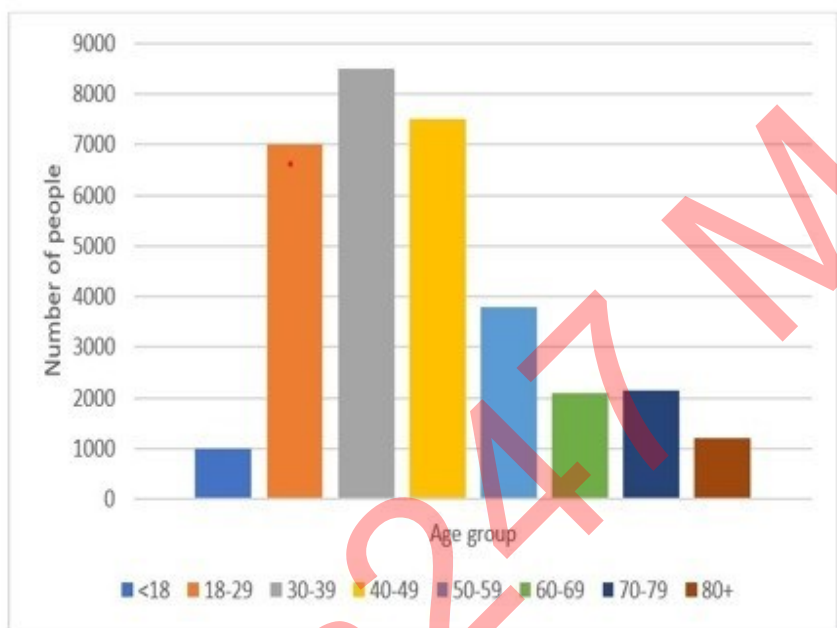

Which age group has the least number of people?

- Ans
- 1. 30-39
  - 2. 80+
  - 3. <18
  - 4. 50-59

Q.7 The centres of two circles are 84 cm apart. If the radii of these two circles are 38 cm and 26 cm, respectively, then which of the following options gives the length (in cm) of a direct common tangent of these two circles?

- Ans
- 1.  $36\sqrt{3}$
  - 2.  $48\sqrt{3}$
  - 3.  $42\sqrt{3}$
  - 4.  $54\sqrt{3}$

Q.8 If  $\sin \theta = \frac{11}{12}$ , then what will be the value of  $(\tan \theta + \sec \theta)$ ?

- Ans
- 1.  $\sqrt{23}$
  - 2.  $\frac{11}{\sqrt{23}}$
  - 3.  $\frac{12}{\sqrt{23}}$
  - 4. 23

Q.9 At an election involving two candidates, 68 votes are declared invalid. The winning candidate gets 52% of the valid votes and wins by 98 votes. The total number of votes polled is:

- Ans
- 1. 2475
  - 2. 2518
  - 3. 2500
  - 4. 2250

Q.10 R can finish a work in 6 days if he works 10 hours a day. S can finish it in 5 days if he works 8 hours a day. If both start a work and work daily for 6 hours, the work will be finished in \_\_\_\_ days.

- Ans
- 1. 3
  - 2. 4
  - 3. 5
  - 4. 6

Q.11 Find the mean proportional between 25 and 81.

- Ans
- 1. 36
  - 2. 12
  - 3. 45
  - 4. 81

Q.12 R and S can finish a work in 10 days, S and T can finish it in 12 days and T and R can finish in 8 days. In how many days will the work be finished if they all work simultaneously?

- Ans
- 1.  $\frac{240}{31}$
  - 2.  $\frac{240}{37}$
  - 3.  $\frac{240}{39}$
  - 4.  $\frac{240}{33}$

Q.13 A solid metallic cylinder of base radius 6 cm and height 10 cm is melted to form small cylinders, each of height 2.5 cm and base radius 2 cm. Find the number of small cylinders.

- Ans
- 1. 32
  - 2. 36
  - 3. 80
  - 4. 360

Q.14 From a circular sheet of circumference 264 cm, two equal maximum-sized circular plates are cut off. What will be the circumference of each plate? (Use  $\pi = \frac{22}{7}$ )

- Ans
- 1. 264 cm
  - 2. 135 cm
  - 3. 176 cm
  - 4. 132 cm

Q.15 The marked price of a battery-operated rickshaw is ₹90,000. It is available for sale at two successive discounts of 10% and 5%. What is the selling price (in ₹) of the battery-operated rickshaw?

- Ans
- 1. 78,950
  - 2. 76,950
  - 3. 75,850
  - 4. 77,850

Q.16 In a triangle ABC, P and Q are two points on AB and AC, respectively, such that PQ parallel to BC. If AC = 5QC, then the ratio PQ : BC is equal to:

- Ans
- 1. 3 : 4
  - 2. 5 : 4
  - 3. 4 : 5
  - 4. 4 : 3

Q.17 Ramesh's pocket money was reduced by 25%, and then the reduced pocket money was increased by 20%. Find the net increase or decrease percentage in his original pocket money.

- Ans
- 1. Decrease 12%
  - 2. Increase 12%
  - 3. Increase 10%
  - 4. Decrease 10%

Q.18 Find the altitude (in cm) of side MT of triangle MNT with side MN = 36 cm, MT = 36 cm and NT = 48 cm.

- Ans
- 1.  $16\sqrt{5}$
  - 2.  $18\sqrt{3}$
  - 3.  $12\sqrt{5}$
  - 4.  $24\sqrt{3}$

Q.19 Study the given graph carefully and answer the question that follows.

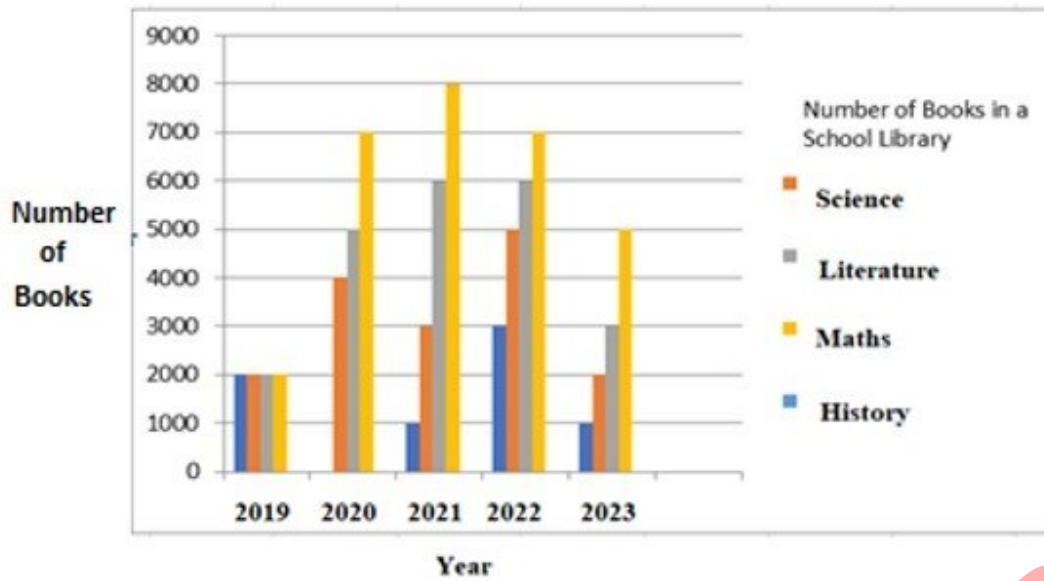

On the bases of this multiple bar graph, What is the change in the number of Literature books from the year 2020 to the year 2023.

- Ans
- 1. 1000 more
  - 2. 2000 less
  - 3. No change
  - 4. 2000 more

Q.20 A sum of money becomes five times its original value in 15 years when invested at a certain simple interest rate. If the sum was invested twice the time at the same rate of interest, what would be the final amount?

- Ans
- 1. The money becomes 7 times its original value
  - 2. The money becomes 9 times its original value
  - 3. The money becomes 6 times its original value
  - 4. The money becomes 8 times its original value

Q.21 A battery manufacturer manufactures five different types of batteries. The total revenue for the year 2020 is ₹25,00,000 and 20,000 units were exported in 2020. The distribution of revenue and units for the five different types of batteries is shown in the charts.



Which type of battery provides the lowest revenue per unit?

- Ans
- 1. Lead acid
  - 2. Sodium
  - 3. M-Air
  - 4. Li-ion



Q.22 What is the value of the following expression?

$$420 \div \left[ \frac{4}{9} \times \left( 1 + \frac{4}{5} \right) \times 5 \right] + \left[ \frac{5}{7} \text{ of } \frac{21}{25} \div \frac{3}{4} \text{ of } \frac{2}{5} \right]$$

- Ans
- 1. 127
  - 2. 139
  - 3. 107
  - 4. 89

Q.23 The speed of a boat in still water is 12 km/h, and the speed of the stream is 3 km/h. A man goes to a place by boat, 45 km and comes back to the starting point. Find the total time taken by him.

- Ans
- 1. 9 hours
  - 2. 6 hours
  - 3. 8 hours
  - 4. 7 hours

Q.24 In an election a candidate secured 47% of the votes and lost to his only opponent by 276 votes. Find the total number of votes polled.

- Ans
- 1. 4000
  - 2. 4200
  - 3. 4600
  - 4. 3800

Q.25 Ramu mixes 2 litres of water at 100° C and 18 litres of water at 32° C. What temperature will the water have after mixing?

- Ans
- 1. 66°C
  - 2. 20°C
  - 3. 38.8°C
  - 4. 40°C

Section : General Awareness

1. The parliamentary standing committees have a tenure of \_\_\_\_\_ years.

- Ans
- 1. one
  - 2. four
  - 3. three
  - 4. two

2. Which military officer led the British forces in the Battle of Chinhat fought in 1857?

- Ans
- 1. Robert Maclagan
  - 2. Henry Lawrence
  - 3. James George Smith
  - 4. Charles Ellice

3. Citizens are NOT discriminated against on the basis of religion, caste or sex because of:

- Ans
- 1. Right to Equality
  - 2. Right against Exploitation
  - 3. Right to Freedom
  - 4. Right to Freedom of Religion

Q.4 Which is the nearest planet to the Sun?

- Ans
- 1. Uranus
  - 2. Jupiter
  - 3. Mercury
  - 4. Saturn

Q.5 Name the Chola inscription that provided details of the way in which the sabha was organised in the local administration in the Chola empire.

- Ans
- 1. Thiruvallangadu inscription
  - 2. Thirunanthikarai inscription
  - 3. Darsanam Koppu inscription
  - 4. Uttaramerur inscription

Q.6 Since 1994, Winter Olympics traditionally take place \_\_\_\_\_ after the Summer Olympics.

- Ans
- 1. 4 years
  - 2. 3 months
  - 3. 6 months
  - 4. 2 years

Q.7 Which of the following statement/s about the Green Revolution is/are CORRECT?

- i. India became self-sufficient with the introduction of the Green Revolution.
- ii. The Green Revolution led to loss of nutrients in the soil from farming the same crop over and over again.
- iii. The Green Revolution led to depletion of fresh ground water.

- Ans
- 1. i, ii and iii
  - 2. Only i and iii
  - 3. Only i and ii
  - 4. Only ii

Q.8 What was the Child Sex Ratio in the country as per the Census of India 2011?

- Ans
- 1. 189
  - 2. 911
  - 3. 981
  - 4. 919

Q.9 As per Census of India 2011, in which of the following states was the total population less than 10 lakh? Ans

- 1. Telangana
- 2. Sikkim
- 3. Goa
- 4. Tripura

Q.10 In MS-Word, a document may be printed using \_\_\_\_\_.

- Ans
- 1. Ctrl+X
  - 2. Ctrl+C
  - 3. Ctrl+P
  - 4. Ctrl+V

Q.11 Which of the following Articles was amended in the Constitution (Fifth Amendment Act), 1955?

- Ans
- 1. Article 45
  - 2. Article 3
  - 3. Article 34
  - 4. Article 17

Q.12 Which of the following is a string instrument commonly featured in the folk music of Gujarat?

- Ans
- 1. turi
  - 2. bungal
  - 3. jantar
  - 4. pava

Q.13 A housemaid gets her 12-year-old daughter to help in her work as a house cleaner at a residential colony instead of sending her to school. Which fundamental duty is violated by the housemaid?

- Ans
- 1. To safeguard public property and to abjure violence
  - 2. To promote harmony and the spirit of common brotherhood
  - 3. To defend the country and render national service
  - 4. To provide opportunities for education to his/her child

Q.14 Which of the following types of music is confined to the states of Karnataka, Andhra Pradesh, Tamil Nadu and Kerala?

- Ans
- 1. Classical
  - 2. Carnatic
  - 3. Regional
  - 4. Hindustani

Q.15 How can you access the Step by Step Mail Merge Wizard in Microsoft Word?

- Ans
- 1. Clicking on the File menu
  - 2. Pressing Ctrl + M
  - 3. Clicking on the Mailings tab
  - 4. Pressing F12

Q.16 Which of the following is a medium-sized globular protein that acts as a pancreatic serine protease found in the digestive system of many vertebrates?

- Ans
- 1. Amylase
  - 2. Lipase
  - 3. Trypsin
  - 4. Pepsin

Q.17 Buddh International Circuit is located at:

- Ans
- 1. Chennai
  - 2. Noida
  - 3. Mumbai
  - 4. Delhi

Q.18 The Supreme Court, in May 2023, observed that it can give divorce on the ground of irretrievable breakdown of marriage by exercising its discretionary power under \_\_\_\_\_.

- Ans
- 1. Article 136 of the Constitution of India
  - 2. Article 32 of the Constitution of India
  - 3. Article 142 of the Constitution of India
  - 4. Article 143 of the Constitution of India

Q.19 What is known to be 'ekaharya', where one dancer takes on many roles in a single performance?

- Ans
- 1. Bharatanatyam
  - 2. Kathak
  - 3. Kuchipudi
  - 4. Kathakali

Q.20 Match the railway zones in column A with their headquarters in column B.

Column A (Railway zones)	Column B (Headquarters)
1. Central	a. New Delhi
2. Northern	b. Mumbai CST
3. Eastern	c. Chennai
4. Southern	d. Kolkata

- Ans
- 1. 1-b, 2-a, 3-d, 4-c
  - 2. 1-b, 2-d, 3-a, 4-c
  - 3. 1-a, 2-b, 3-d, 4-c
  - 4. 1-b, 2-a, 3-c, 4-d

Q.21 The central stretch of the Western Coastal Plains of India is known as the:

- Ans
- 1. Konkan coast
  - 2. Coromandel coast
  - 3. Malabar coast
  - 4. Kannad plains

Q.22 The Kutch festival is held at \_\_\_\_\_.

- Ans
- 1. Surat
  - 2. Rajkot
  - 3. Bhuj
  - 4. Ahmedabad

Q.23 What is the use of Net National Product (NNP)?

- Ans
- 1. To calculate per capita income
  - 2. To calculate exports
  - 3. To calculate balance of payments
  - 4. To calculate imports

Q.24 In which year did Galileo describe the regular, swinging motion of a pendulum by the action of gravity and acquired momentum?

- Ans
- 1. 1605
  - 2. 1600
  - 3. 1599
  - 4. 1602

Q.25 In which year was the first Arjuna Award given to a woman hockey player?

- Ans
- 1. 1964
  - 2. 1963
  - 3. 1962
  - 4. 1961

## Combined Higher Secondary Level Examination 2024 Tier I

Exam Date	08/07/2024
Exam Time	5:15 PM - 6:15 PM
Subject	CHSL Exam 2024 Tier I

### Section : English Language

1. The given sentence is divided into four segments. Select the option that has the segment with a grammatical error. The sun rises / in an east / and sets / in the west.

- Ans
- 1. in the west.
  - 2. and sets
  - 3. the sun rises
  - 4. in an east

2. The given sentence is divided into three segments. Select the option that has the segment with a grammatical error. If there is no error, select 'No error'.  
The judges eliminated the / classical singer, as she dropped of / in the middle of the competition.

- Ans
- 1. in the middle of the competition.
  - 2. The judges eliminated the
  - 3. classical singer, as she dropped of
  - 4. No error

3. The following sentence has been divided into four segments. Identify the segment that contains an error.

How long are you working / for your current employer / and why don't you / look for better opportunities?

- Ans
- 1. look for better opportunities
  - 2. and why don't you
  - 3. How long are you working
  - 4. for your current employer

Q.4 Select the most appropriate option to fill in the blank.

All the players from this athletic club participated in the tournament and \_\_\_\_\_ one of them got a medal.

- Ans
- 1. none
  - 2. each
  - 3. they
  - 4. all

**Comprehension:**

In the following passage, some words have been deleted. Read the passage carefully and select the most appropriate option to fill in each blank.

A few months after Conrads death, the nobles met at Aix-la-Chapelle and elected Henry to be their king. At this time, it was the (1)\_\_\_\_\_in Europe to hunt various birds, such as the wild duck and partridge, with falcons. The falcons were long-winged birds of prey, (2)\_\_\_\_\_hawks. They were trained to (3)\_\_\_\_\_on their masters wrist and wait patiently until they were told to fly. Then they would swiftly (4) \_\_\_\_\_ at their prey and bear it to the ground. Henry was very fond of falconry and hence was known as Henry the Fowler, or Falconer. As soon as the other dukes had elected him king, a messenger was sent to Saxony to (5)\_\_\_\_\_him of the honour done for him. After a search of some days, he was at last found, far up in the Hartz Mountains, hunting with his falcons.

**SubQuestion No : 5**

**Q.5** Select the most appropriate option to fill in blank number 1.

- Ans**
- 1. custom
  - 2. ritualistic
  - 3. motive
  - 4. conventions

**Comprehension:**

In the following passage, some words have been deleted. Read the passage carefully and select the most appropriate option to fill in each blank.

A few months after Conrads death, the nobles met at Aix-la-Chapelle and elected Henry to be their king. At this time, it was the (1)\_\_\_\_\_in Europe to hunt various birds, such as the wild duck and partridge, with falcons. The falcons were long-winged birds of prey, (2)\_\_\_\_\_hawks. They were trained to (3)\_\_\_\_\_on their masters wrist and wait patiently until they were told to fly. Then they would swiftly (4) \_\_\_\_\_ at their prey and bear it to the ground. Henry was very fond of falconry and hence was known as Henry the Fowler, or Falconer. As soon as the other dukes had elected him king, a messenger was sent to Saxony to (5)\_\_\_\_\_him of the honour done for him. After a search of some days, he was at last found, far up in the Hartz Mountains, hunting with his falcons.

**SubQuestion No : 6**

**Q.6** Select the most appropriate option to fill in blank number 2.

- Ans**
- 1. subjugating
  - 2. echoing
  - 3. favouring
  - 4. resembling

**Comprehension:**

In the following passage, some words have been deleted. Read the passage carefully and select the most appropriate option to fill in each blank.

A few months after Conrads death, the nobles met at Aix-la-Chapelle and elected Henry to be their king. At this time, it was the (1)\_\_\_\_\_in Europe to hunt various birds, such as the wild duck and partridge, with falcons. The falcons were long-winged birds of prey, (2)\_\_\_\_\_hawks. They were trained to (3)\_\_\_\_\_on their masters wrist and wait patiently until they were told to fly. Then they would swiftly (4) \_\_\_\_\_ at their prey and bear it to the ground. Henry was very fond of falconry and hence was known as Henry the Fowler, or Falconer. As soon as the other dukes had elected him king, a messenger was sent to Saxony to (5)\_\_\_\_\_him of the honour done for him. After a search of some days, he was at last found, far up in the Hartz Mountains, hunting with his falcons.

**SubQuestion No : 7**

**Q.7** Select the most appropriate option to fill in blank number 3.

- Ans**
- 1. lurch
  - 2. chirp
  - 3. sitting
  - 4. perch

**Comprehension:**

In the following passage, some words have been deleted. Read the passage carefully and select the most appropriate option to fill in each blank.

A few months after Conrads death, the nobles met at Aix-la-Chapelle and elected Henry to be their king. At this time, it was the (1)\_\_\_\_\_ in Europe to hunt various birds, such as the wild duck and partridge, with falcons. The falcons were long-winged birds of prey, (2)\_\_\_\_\_ hawks. They were trained to (3)\_\_\_\_\_ on their masters wrist and wait patiently until they were told to fly. Then they would swiftly (4) \_\_\_\_\_ at their prey and bear it to the ground. Henry was very fond of falconry and hence was known as Henry the Fowler, or Falconer. As soon as the other dukes had elected him king, a messenger was sent to Saxony to (5)\_\_\_\_\_ him of the honour done for him. After a search of some days, he was at last found, far up in the Hartz Mountains, hunting with his falcons.

**SubQuestion No : 8**

**Q.8** Select the most appropriate option to fill in blank number 4.

- Ans**
- 1. leapt
  - 2. flight
  - 3. dart
  - 4. dashed

**Comprehension:**

In the following passage, some words have been deleted. Read the passage carefully and select the most appropriate option to fill in each blank.

A few months after Conrads death, the nobles met at Aix-la-Chapelle and elected Henry to be their king. At this time, it was the (1)\_\_\_\_\_ in Europe to hunt various birds, such as the wild duck and partridge, with falcons. The falcons were long-winged birds of prey, (2)\_\_\_\_\_ hawks. They were trained to (3)\_\_\_\_\_ on their masters wrist and wait patiently until they were told to fly. Then they would swiftly (4) \_\_\_\_\_ at their prey and bear it to the ground. Henry was very fond of falconry and hence was known as Henry the Fowler, or Falconer. As soon as the other dukes had elected him king, a messenger was sent to Saxony to (5)\_\_\_\_\_ him of the honour done for him. After a search of some days, he was at last found, far up in the Hartz Mountains, hunting with his falcons.

**SubQuestion No : 9**

**Q.9** Select the most appropriate option to fill in blank number 5.

- Ans**
- 1. inform
  - 2. nullify
  - 3. communicate
  - 4. convey

**Q.10** Select the most appropriate option that can substitute the underlined segment in the given sentence.

The player was declared fit and in excellent health to play the final matches.

- Ans**
- 1. right as rain
  - 2. left out in cold
  - 3. on cloud nine
  - 4. up in the arms

**Q.11** Select the most appropriate homonym to fill in the blank.

The prince is the \_\_\_\_\_ to the throne.

- Ans**
- 1. air
  - 2. heir
  - 3. err
  - 4. ere

**Q.12** Select the most appropriate option that can replace the bracketed word segment in the following sentence.

Men (allowed) for Olympic artistic swimming for the first time at the 2024 Paris Games, the IOC confirmed on Thursday.

- Ans**
- 1. are likely
  - 2. have permitted
  - 3. will approve
  - 4. are eligible

Q.13 Select the most appropriate ANTONYM of the given word.

Terminate

- Ans
- 1. Mark
  - 2. Die
  - 3. Conclude
  - 4. Begin

Q.14 Select the most appropriate option to fill in the blank.

The \_\_\_\_\_ purpose of the coaching was to identify the talented players.

- Ans
- 1. mane
  - 2. mine
  - 3. mean
  - 4. main

Q.15 Select the most appropriate option that can substitute the underlined segment in the given sentence.

As there was no one to look thorough the orphan, he had to take refuge in the orphanage.

- Ans
- 1. look down upon
  - 2. look after
  - 3. look upon
  - 4. look through

Q.16 Select the most appropriate pair of words to fill in the blanks.

Shyam has reserved a \_\_\_\_\_ in the train for his wife as she will be giving \_\_\_\_\_ to his child soon.

- Ans
- 1. birth; birth
  - 2. berth; birth
  - 3. berth; berth
  - 4. birth; berth

Q.17 Select the most appropriate option that can substitute the underlined word in the given sentence.

Loud noise effects our ability to concentrate.

- Ans
- 1. affects
  - 2. bestows
  - 3. results
  - 4. intensifies

Q.18 There is a spelling error in the given sentence. Select the option that contains the INCORRECTLY spelt word.

They addressed the special gathering perfectly.

- Ans
- 1. adressed
  - 2. special
  - 3. gathering
  - 4. perfectly

Q.19 Select the most appropriate homophone to fill in the blank.

These people are artists. \_\_\_\_\_ skills are extraordinary.

- Ans
- 1. They or
  - 2. There
  - 3. They're
  - 4. Their



Q.20 Select the INCORRECTLY spelt word.

- Ans
- 1. Conscience
  - 2. Consciencious
  - 3. Conspicuous
  - 4. Conscious

Q.21 Select the most appropriate meaning of the given idiom.

To read between the lines

- Ans
- 1. To grasp the hidden meaning
  - 2. To read without concentration
  - 3. To read aloud
  - 4. To whisper

Q.22 Select the most appropriate ANTONYM of the given word.  
Peace

- Ans
- 1. Harmony
  - 2. Strange
  - 3. Turmoil
  - 4. Refusal

Q.23 Select the most appropriate ANTONYM of the underlined word in the given sentence.  
His industrious attitude was the reason for his promotion.

- Ans
- 1. Efficient
  - 2. Hazy
  - 3. Lazy
  - 4. Pricey

Q.24 Select the most appropriate option that can substitute the underlined words in the following sentence.  
I cannot go out tonight because I will preparing of my interview tomorrow.

- Ans
- 1. I have to prepare for
  - 2. I will have prepare for
  - 3. I have been prepare to
  - 4. I had to prepare to

Q.25 Complete the following sentence.

He \_\_\_\_\_ to the manager about the terrible food in the hostel.

- Ans
- 1. He made a complaint .
  - 2. He terribly complained.
  - 3. He said a complaint .
  - 4. He said a big complaint .

1. This question consists of a pair of words which have a certain relationship to each other. Select the pair which does NOT have the same relationship.

Adhere : Comply

- 1) Accord : Harmony
- 2) Busy : Engaged
- 3) Eager : Keen
- 4) Jubilant : Depressed

Ans  1. 1  
 2. 4  
 3. 3  
 4. 2

2. The position of how many letters will remain unchanged if each of the letters in the word PRAISE is arranged in the alphabetical order?

Ans  1. None  
 2. Two  
 3. Three  
 4. One

Q.3 What would be the Roman numeral on the opposite side of 'IX' if the given sheet is folded to form a cube?

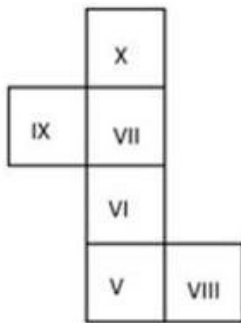

Ans  1. VI  
 2. X  
 3. V  
 4. VIII

Q.4 Select the correct mirror image of the given figure when the mirror is placed at MN as shown below.



Ans  1. G F X D 3 9 Z L  
 2. J S E D 3 9 Z L  
 3. G F X D 3 9 Z L  
 4. G F X D 3 9 Z L

Q.5 Identify the figure given in the options that when put in place of the question mark (?) will logically complete the series.

H	C	H	O	
O	3	6	C	?
C	3	O	O	C
H	O	C	H	6

Ans

✗ 1.

	C
H	
O	E

✗ 2.

	H
E	
O	6

✗ 3.

	H
O	
C	E

✓ 4.

	H
E	
6	O

Q.6 Which two numbers should be interchanged to make the given equation correct?

$$(86 \div 43) + (66 \div 33) \times 2 + 72 - 6 \times 4 = 177$$

(NOTE: Numbers must be interchanged and not the constituent digits e.g. if 2 and 3 are to be interchanged in the equation  $43 \times 3 + 4 \div 2$ , then interchanged equation is  $43 \times 2 + 4 \div 3$ )

- Ans
- ✓ 1. 43 and 2
  - ✗ 2. 2 and 6
  - ✗ 3. 2 and 4
  - ✗ 4. 2 and 72

Q.7 Four letter-clusters have been given, out of which three are alike in some manner and one is different. Select the letter-cluster that is different.

(Note: The odd one out is not based on the number of consonants/vowels or their position in the letter cluster.)

- Ans
- ✓ 1. ZABX
  - ✗ 2. NMNM
  - ✗ 3. TGHS
  - ✗ 4. KPQJ

**Q.8** Select the set in which the numbers are related in the same way as are the numbers of the following sets.  
 (NOTE: Operations should be performed on the whole numbers, without breaking down the numbers into its constituent digits. E.g., 13 – Operations on 13 such as adding /deleting /multiplying etc. to 13 can be performed. Breaking down 13 into 1 and 3 and then performing mathematical operations on 1 and 3 is not allowed.)  
 (60, 15, 5)  
 (96, 24, 8)

- Ans**
- 1. (159, 39, 13)
  - 2. (150, 36, 13)
  - 3. (156, 39, 11)
  - 4. (156, 39, 13)

**Q.9** What should come in place of the question mark (?) in the given series based on the English alphabetical order?  
 FHB, KMG, PRL, UWQ, ?

- Ans**
- 1. ZVB
  - 2. ZDV
  - 3. ZCV
  - 4. ZBV

**Q.10** How many semi circles are there in the given figure?

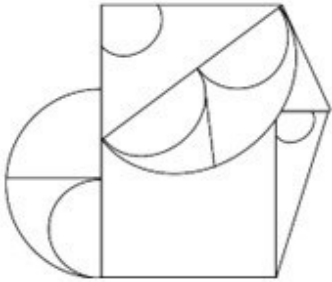

- Ans**
- 1. 6
  - 2. 5
  - 3. 7
  - 4. 4

**Q.11** Select the option in which the given figure is embedded. (Rotation is NOT allowed.)

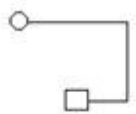

- Ans**
- 1.
  - 2.
  - 3.
  - 4.

Q.12 21 is related to 59 by certain logic. Following the same logic, 32 is related to 81. To which of the following is 29 related, following the same logic?  
(NOTE: Operations should be performed on the whole numbers, without breaking down the numbers into its constituent digits. E.g. 13 – Operations on 13 such as adding/subtracting/multiplying etc. to 13 can be performed. Breaking down 13 into 1 and 3 and then performing mathematical operations on 1 and 3 is not allowed.)

- Ans
- 1. 58
  - 2. 75
  - 3. 60
  - 4. 62

Q.13 In a certain code language, 'LDWR' is coded as 'NGUQ' and 'BFKZ' is coded as 'DIIY'. What is the code for 'YTGX' in the given code language?

- Ans
- 1. AWEW
  - 2. ZVFN
  - 3. YWFV
  - 4. BWFV

Q.14 What would be the letter on the opposite side of 'S' if the given sheet is folded to form a cube?

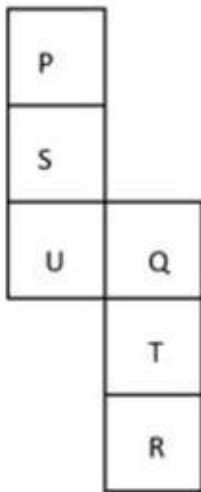

- Ans
- 1. Q
  - 2. T
  - 3. P
  - 4. R

Q.15 'STAUNCH' is related to 'WXEYRGL' in a certain way based on the English alphabetical order. In the same way, 'BLISS' is related to 'FPMWW'. To which of the following is 'COWARD' related, following the same logic?

- Ans
- 1. GTAEVH
  - 2. GSAEVH
  - 3. GSAFVH
  - 4. GSZEVH

Q.16 What should come in place of the question mark (?) in the given series?

138, 137, 140, 139, 142, ?

- Ans
- 1. 143
  - 2. 141
  - 3. 140
  - 4. 142

Q.17 Select the correct mirror image of the given figure when the mirror is placed at MN as shown below.

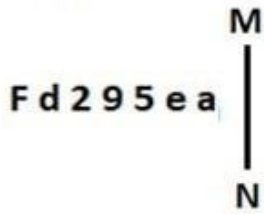

- Ans
- 1. **ae295bf**
  - 2. **ae29zbf**
  - 3. **ae29zpf**
  - 4. **ae29zbf**

Q.18 What will come in the place of the question mark (?) in the following equation, if '+' and '-' are interchanged and 'x' and '÷' are interchanged?

$$34 + 56 \times 8 \div 2 - 16 = ?$$

- Ans
- 1. **36**
  - 2. **23**
  - 3. **38**
  - 4. **30**

Q.19 If 'A' stands for '+', 'B' stands for 'x', 'C' stands for '÷' and 'D' stands for '-', what will come in place of the question mark (?) in the following equation?

$$404 \text{ B } 2 \text{ D } 101 \text{ A } 101 \text{ C } 6 = ?$$

- Ans
- 1. **831**
  - 2. **830**
  - 3. **813**
  - 4. **803**

Q.20 The position of how many letters will remain unchanged if each of the letters in the word CHEMISTRY is arranged in alphabetical order?

- Ans
- 1. **Three**
  - 2. **Four**
  - 3. **One**
  - 4. **Two**

Q.21 In a certain code language, 'DEAL' is coded as '0368' and 'DEAF' is coded as '2630'. What is the code for 'F' in that language?

- Ans
- 1. **3**
  - 2. **2**
  - 3. **0**
  - 4. **8**

Q.22 Three statements are followed by conclusions numbered I, II. You have to consider these statements to be true, even if they seem to be at variance with commonly known facts. Decide which of the given conclusions logically follows from the given statement.

Statements:

All shoes are ties.

Some ties are pants.

All pants are buttons.

Conclusion (I): Some buttons are shoes.

Conclusion (II): No ties are buttons.

- Ans
- 1. Both conclusions (I) and (II) follow.
  - 2. Only conclusion (II) follows.
  - 3. Neither conclusion (I) nor (II) follows.
  - 4. Only conclusion (I) follows.

Q.23 In a certain language,  
A # B means A is the sister of B,  
A @ B means A is the son of B,  
A & B means A is the wife of B and  
A % B means A is the father of B.  
E & P @ D % K # L  
Based on the above, how is E related to K?

- Ans
- 1. Sister
  - 2. Brother's wife
  - 3. Mother
  - 4. Mother's mother

Q.24 What should come in place of the question mark (?) to complete the following letter-cluster series?  
YBP, WDS, TGQ, OLT, ?

- Ans
- 1. HSR
  - 2. HSP
  - 3. LSR
  - 4. HTR

Q.25 Which two numbers should be interchanged to make the given equation correct?

$$79 - 43 + (23 + 75) \times 3 - (30 \div 15) \times 4 = 175$$

(NOTE: Numbers must be interchanged and not the constituent digits e.g. if 2 and 3 are to be interchanged in the equation  $43 \times 3 + 4 \div 2$ , then interchanged equation is  $43 \times 2 + 4 \div 3$ )

- Ans
- 1. 3 and 4
  - 2. 75 and 79
  - 3. 75 and 30
  - 4. 23 and 43

Q.1

The following table shows admitted students in an institute during the academic years 2015 to 2020 in different courses.

Academic year	Engineering	Science	Arts	Management
2015	1200	850	450	240
2016	1362	821	525	275
2017	1351	870	624	286
2018	1409	921	615	293
2019	1421	931	795	300
2020	1400	950	750	320

Which of the following course had either a consistent growth or a consistent decline in the admissions from 2015 to 2020?

- Ans
- ✓ 1. Management
  - ✗ 2. Engineering
  - ✗ 3. Arts
  - ✗ 4. Science

Q.2 In an election contested by two candidates, one candidate got 42% of the total votes and still lost by 800 votes. Find the total number of votes that were cast.

- Ans
- ✗ 1. 7000
  - ✗ 2. 2000
  - ✗ 3. 8000
  - ✓ 4. 5000

Q.3 Study the given three-dimensional chart and answer the question that follows. The chart details the sale of fruits in different months.



Which fruit was the most sold in the month of May and how much more than the lowest-sold fruit in that month ?

- Ans
- ✗ 1. Kiwi, 23
  - ✓ 2. Apple, 28
  - ✗ 3. Orange, 23
  - ✗ 4. Kiwi, 22



Q.4 Find the cost of painting a ball that is in the shape of a sphere with a radius of 14 cm. The painting cost of the ball is ₹5 per square centimetre (take  $\pi = \frac{22}{7}$ ).

- Ans
- ✓ 1. ₹12,320
  - ✗ 2. ₹13,220
  - ✗ 3. ₹13,022
  - ✗ 4. ₹12,230

Q.5 The distance between the centres of two circles is 81 cm, and their radii are 42 cm and 51 cm. What is the length (in cm) of the direct common tangent to the circles?

- Ans
- ✗ 1.  $51\sqrt{6}$
  - ✓ 2.  $36\sqrt{5}$
  - ✗ 3.  $31\sqrt{3}$
  - ✗ 4.  $40\sqrt{2}$

Q.6 The given graph shows the higher secondary result of a particular school, from 2019 to 2021. Study the graph and answer the question that follows.

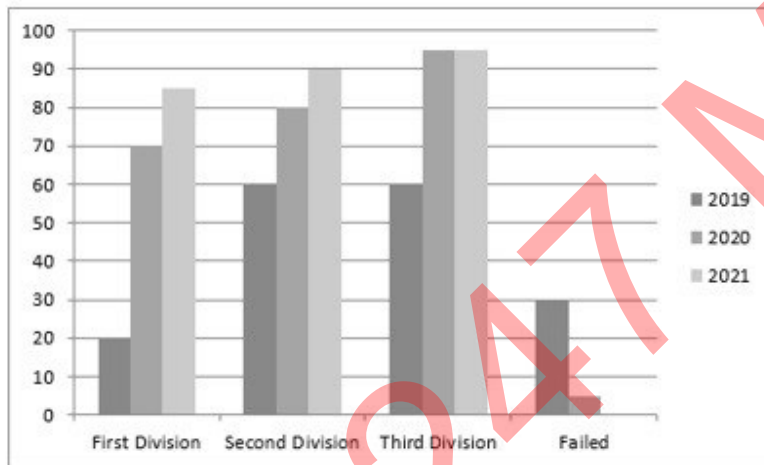

The ratio of the number of students who passed with first division in all the 3 years to the total number of students in 2020 is:

- Ans
- ✓ 1. 7 : 10
  - ✗ 2. 7 : 13
  - ✗ 3. 7 : 15
  - ✗ 4. 17 : 10

Q.7 Ram is 20 years older than Rahul. 'n' years ago Ram was thrice as old as Rahul. '2n' years from now the ratio of the ages of Ram and Rahul will be 15 : 11. What is the value of 'n'?

- Ans
- ✓ 1. 15
  - ✗ 2. 10
  - ✗ 3. 30
  - ✗ 4. 20

Q.8 Which of the following statements is INCORRECT about the circle?

Ans

1. The area of a sector =  $\frac{1}{2}$  (arc length  $\times$  R).

2. The length of an arc =  $\frac{\text{central angle made by the arc}}{360^\circ} \times \pi r^2$ .

3. The radius of an incircle of an equilateral triangle of side 's' is  $\frac{s}{2\sqrt{3}}$ .

4. Circles are congruent if they have same radii while similar circles may have different radii.

Q.9 The inner and outer radii of a hemispherical wooden bowl are 6 cm and 8 cm, respectively. Its entire surface has to be polished and the cost of polishing  $\pi$  cm<sup>2</sup> is Rs.50. How much will it cost to polish the bowl?

Ans

1. Rs.12,000

2. Rs.10,000

3. Rs.11,600

4. Rs.11,400

Q.10 A man can row a boat at speed 8 km/h in still water. It takes thrice as long to row upstream as it does to row downstream. Find the speed of the stream (in km/h).

Ans

1. 5

2. 4

3. 6

4. 3

Q.11 The value of a machine depreciates every year by 5%. If the present value of the machine is ₹80,000, what will be its value after 2 years?

Ans

1. ₹72,200

2. ₹74,400

3. ₹74,000

4. ₹72,000

Q.12 Simplify the expression  $720 + 48 \div 8 \times 5 - 6 \times 3$ .

Ans

1.  $\frac{112}{5}$

2. 732

3. 161

4. 242

Q.13 If A : B = 2 : 3 and B : C = 7 : 8, find A : C.

Ans

1. 12 : 7

2. 7 : 12

3. 4 : 7

4. 7 : 2

Q.14

If  $\cos^4\theta - \sin^4\theta = 4/5$ , then find the value of  $\sin 4\theta$ .

Ans

✓ 1.  $\frac{24}{25}$

✗ 2.  $\frac{21}{25}$

✗ 3.  $\frac{16}{25}$

✗ 4.  $\frac{18}{25}$

Q.15 Two triangles ABC and DEF are similar. The smallest side of ABC is equal to 15 units. If the sides of ABC are in the ratio 3 : 4 : 5, and the area of DEF is half of the area of ABC, then what is the largest side of DEF (in units)?

Ans

✗ 1.  $25\sqrt{2}$

✗ 2.  $25\sqrt{3}$

✗ 3.  $\frac{25}{\sqrt{3}}$

✓ 4.  $\frac{25}{\sqrt{2}}$

Q.16 Tanvi can do a work in 25 days, and Tai can complete the same work in 30 days. They started the work together for 5 days. How much work is left?

Ans

✗ 1.  $\frac{11}{30}$

✓ 2.  $\frac{19}{30}$

✗ 3.  $\frac{11}{12}$

✗ 4.  $\frac{1}{12}$

Q.17 Two cubes, each of edge 5 cm, are joined face to face. Find the surface area of the cuboid thus formed.

Ans

✗ 1.  $300 \text{ cm}^2$

✗ 2.  $125 \text{ cm}^2$

✗ 3.  $200 \text{ cm}^2$

✓ 4.  $250 \text{ cm}^2$

Q.18

Ram invested a certain sum of money at simple interest. It amounted to  $\frac{5}{4}$  of itself in 3 years. What will be its rate per cent per annum?

- Ans
- 1. 9.12%
  - 2. 8.33%
  - 3. 8.20%
  - 4. 7.25%

Q.19

A sells an object to B at 10% profit, B sells it to C at 60% profit and C sells it to D at 12  $\frac{1}{2}$ % profit. If D paid ₹59.40, then at what price did A buy it?

- Ans
- 1. ₹30
  - 2. ₹32
  - 3. ₹28
  - 4. ₹34

Q.20

Solve  $\frac{2 \times 2 + 2}{2 + 2 \times 2} \div \frac{\frac{1}{2} \div \frac{1}{2} \text{ of } \frac{1}{2}}{\frac{1}{2} + \frac{1}{2} \text{ of } \frac{1}{2}}$

- Ans
- 1.  $4\frac{1}{8}$
  - 2.  $3\frac{1}{8}$
  - 3.  $2\frac{1}{8}$
  - 4.  $1\frac{1}{8}$

Q.21

On buying 24 bangles Meena gets 6 bangles free of cost. By what percentage does Meena get a discount?

- Ans
- 1. 20%
  - 2. 5%
  - 3. 15%
  - 4. 10%

Q.22

Study the given histogram and answer the questions that follow.

The histogram shows the distribution of marks obtained by 115 students in a college.

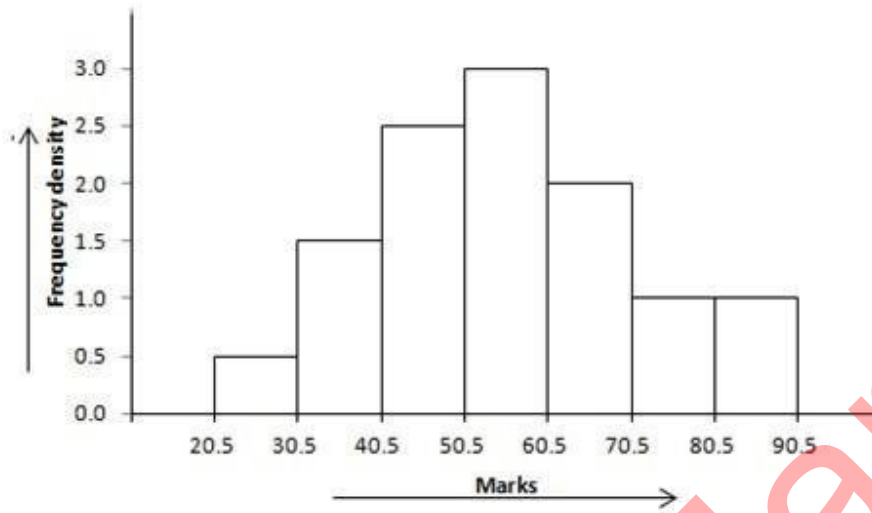

A student is marked as qualified if he/she obtains marks above 40.5. Here, the ratio of the number of qualified students to that of students who are not qualified is:

- Ans
- 1. 9 : 2
  - 2. 5 : 1
  - 3. 19 : 4
  - 4. 17 : 4

Q.23 The average weight of 35 students in a class is 40 kgs. Five of the students of this class whose average weight is 42 kgs left the class. Find the average weight of the remaining 30 students.

- Ans
- 1.  $39\frac{2}{3}$  kgs
  - 2.  $19\frac{2}{3}$  kgs
  - 3.  $49\frac{2}{3}$  kgs
  - 4.  $29\frac{2}{3}$  kgs

Q.24 Side BC of a  $\Delta ABC$  is extended upto D such that  $CD = AC$ . If  $\angle BAD = 118^\circ$  and  $\angle ACB = 80^\circ$ , then the value of  $\angle ABC$  is equal to:

- Ans
- 1.  $36^\circ$
  - 2.  $32^\circ$
  - 3.  $22^\circ$
  - 4.  $27^\circ$

Q.25 5% of 2% of 3 is equal to:

- Ans
- 1. 0.3
  - 2. 3
  - 3. 0.003
  - 4. 0.03

Section : General Awareness

1. Khelo India Winter Games 2023 was held at \_\_\_\_\_.

- Ans
- 1. Himachal Pradesh
  - 2. Jammu and Kashmir
  - 3. Leh
  - 4. Uttarakhand

2. Which amongst the following Sultans shifted his capital from Delhi to Daulatabad?

- Ans
- 1. Muhammad Bin Tughlaq
  - 2. Feroz Shah Tughlaq
  - 3. Sikandar Lodhi
  - 4. Ibrahim Lodhi

3. As of March, 2024, who is the Executive Chairman of the National Legal Services Authority of India?

- Ans
- 1. Justice UU Lalit
  - 2. Justice Sanjiv Khanna
  - 3. Justice Ranjan Gogoi
  - 4. Justice Sharad Bobde

Q.4 \_\_\_\_\_ of the Constitution of India has provisions for legal enforcement of the fundamental rights.

- Ans
- 1. Article 28
  - 2. Article 19
  - 3. Article 32
  - 4. Article 29

Q.5 Which statement about Classical Carnatic Music is correct?

- Ans
- 1. The compositions are either in Malayalam, Marathi, Tamil or Bengali.
  - 2. The compositions are either in Telugu, Kannada, Tamil or Sanskrit.
  - 3. The compositions are either in Telugu, Malayalam, Hindi or Sanskrit.
  - 4. The compositions are either in Marathi, Odia, Konkani or Bengali.

Q.6 Which of the following is NOT compulsory equipment for a football referee?

- Ans
- 1. Red and yellow cards
  - 2. White flag
  - 3. Whistle(s)
  - 4. Watch(es)

Q.7 To create a new MS Word document, which of the following steps is correct?

- Ans
- 1. File Tab → Open
  - 2. File Tab → Start
  - 3. File Tab → New
  - 4. File Tab → Recent

Q.8 Lal Thanhawla holds the record for the longest-serving Chief Minister of \_\_\_\_\_, occupying the position for five terms.

- Ans
- 1. Sikkim
  - 2. Manipur
  - 3. Mizoram
  - 4. Meghalaya

Q.9 Which of the following dances is listed in the UNESCO List of Intangible Cultural Heritage of India since 2010?

- Ans
- 1. Kalbelia
  - 2. Garba
  - 3. Ghumar
  - 4. Matki

Q.10 The Assam government observed the birthday of \_\_\_\_\_ on 31 March 2023, as Students Day in the state.

- Ans
- 1. Bodoifa Upendra Nath Brahma
  - 2. Biraj Kumar Sarma
  - 3. Prafulla Kumar Mahanta
  - 4. Bhriugu Kumar Phukan

Q.11 As per the Census-2011, the total absolute increase in population during the decade is \_\_\_\_\_.

- Ans
- 1. 15.23 crore
  - 2. 17.21 crore
  - 3. 16.41 crore
  - 4. 18.19 crore

Q.12 Which of the following is NOT related to the 'Trinity of Carnatic Music'?

- Ans
- 1. Syama Shastri
  - 2. Tyagaraja
  - 3. Muthuswami Dikshitar
  - 4. Purandara Das

Q.13 According to Koeppen's Scheme of classification of climate, which of the following characteristics is associated with 'Group E'?

- Ans
- 1. The average temperature of the coldest month is  $-3^{\circ}\text{C}$  or below
  - 2. The average temperature of the coldest month is higher than  $-3^{\circ}\text{C}$  but below  $18^{\circ}\text{C}$
  - 3. The average temperature of the coldest month is  $18^{\circ}\text{C}$  or higher
  - 4. The average temperature for all months is below  $10^{\circ}\text{C}$

Q.14 Doljatra is a festival of which state from followings?

- Ans
- 1. Rajasthan
  - 2. Assam
  - 3. Haryana
  - 4. Uttar Pradesh

Q.15 Price control and rationing are direct control measures to check \_\_\_\_\_.

- Ans
- 1. disinflation
  - 2. deflation
  - 3. inflation
  - 4. reflation

Q.16 Application software includes a variety of programs that are designed to meet the information processing needs of \_\_\_\_\_.

- Ans
- 1. programmers
  - 2. team leaders
  - 3. customers
  - 4. end users

Q.17 Which sport is NOT played in mixed doubles?

- Ans
- 1. Handball
  - 2. Badminton
  - 3. Tennis
  - 4. Table tennis

Q.18 How many Fundamental Rights were initially provided in the Constitution of India?

- Ans
- 1. Six
  - 2. Nine
  - 3. Seven
  - 4. Eight

Q.19 Which of the following is the correct relationship?

- Ans
- 1.  $F = a/m$
  - 2.  $F = m/a$
  - 3.  $F = m^2a$
  - 4.  $F = ma$

Q.20 As of March 2020, which of the following solar power plants is the biggest plant in the world, with total installed capacity of 2,245 MW?

- Ans
- 1. Kamuthi solar power project
  - 2. Sakri photovoltaic solar energy project
  - 3. Dhirubhai Ambani solar park
  - 4. Bhadla solar park

Q.21 Select the olfactory indicator from among the given options.

- Ans
- 1. Petunia
  - 2. Clove oil
  - 3. Turmeric
  - 4. Cabbage juice

Q.22 Which of the following committees was associated with Industrial Licensing Policy Inquiry?

- Ans
- 1. Gadgil Committee
  - 2. Hazari Committee
  - 3. Sen Committee
  - 4. Dutt Committee

Q.23 Which of the following is NOT one of the classical languages of India?

- Ans
- 1. Magahi
  - 2. Malayalam
  - 3. Kannada
  - 4. Odiya



**Q.24** Select the natural habitat of the Asiatic Lion from the following.

- Ans**
- 1. Gir forest
  - 2. Sundarbans
  - 3. Kanha National Park
  - 4. Saranda forest

**Q.25** At which place did Raja Ram Mohan Roy form a reform association called Brahmo Sabha in the year 1828?

- Ans**
- 1. Calcutta
  - 2. Bombay
  - 3. Pune
  - 4. Madras

Adda247 Marathi

## Combined Higher Secondary Level Examination 2024 Tier I

Exam Date	09/07/2024
Exam Time	9:00 AM - 10:00 AM
Subject	CHSL Exam 2024 Tier I

### Section : English Language

1. The following sentence has been split into four segments. Identify the segment that contains a grammatical error.

In geography class, / the teacher told the students, / "Switzerland lies / inside Germany, France, Austria, and Italy."

- Ans
- 1. inside Germany, France, Austria, and Italy.
  - 2. In geography class,
  - 3. Switzerland lies
  - 4. the teacher told the students,

2. Parts of the following sentence have been given as options. Select the option that contains an error. There are eight planets in our solar system and a Earth is the third planet from the Sun.

- Ans
- 1. planet from the Sun.
  - 2. in our solar system
  - 3. and a Earth is the third
  - 4. There are eight planets

3. The following sentence has been split into four segments. Identify the segment that contains a grammatical error. 'You expressed your opinion/ very clearly /but I am sorry/ I cannot agree to you'.

- Ans
- 1. You expressed your opinion
  - 2. very clearly
  - 3. I cannot agree to you
  - 4. but I am sorry

Q.4 Select the most appropriate option to fill in the blank.

Serena \_\_\_\_\_ from fever since the 5<sup>th</sup> of this month.

- Ans
- 1. is suffering
  - 2. has been suffering
  - 3. suffers
  - 4. suffered

**Comprehension:**

In the following passage, some words have been deleted. Read the passage carefully and select the most appropriate option to fill in each blank.

The disclaimer read that no animals were harmed (1)\_\_\_\_\_the filming of that scene. However, they forgot that the brand of lipstick that was applied (2)\_\_\_\_\_the heroines lips for that scene was manufactured from crushed cochineal bugs, which release a pigment commonly used in red lipstick. The other items in the film studio (3)\_\_\_\_\_used animal fats during their manufacturing. The actors who (4)\_\_\_\_\_that they are vegan in past interviews are unaware of their indirect involvement in such acts of cruelty against animals. The indirect cruelty against animals does not stop here. For example, the extensive disposal of plastic waste in oceans has made plastic a part of the animal food chain, which is detrimental (5)\_\_\_\_\_our entire ecosystem.

**SubQuestion No : 5**

**Q.5** Select the most appropriate option to fill in blank number 1.

- Ans**
- 1. during
  - 2. around
  - 3. from
  - 4. for

**Comprehension:**

In the following passage, some words have been deleted. Read the passage carefully and select the most appropriate option to fill in each blank.

The disclaimer read that no animals were harmed (1)\_\_\_\_\_the filming of that scene. However, they forgot that the brand of lipstick that was applied (2)\_\_\_\_\_the heroines lips for that scene was manufactured from crushed cochineal bugs, which release a pigment commonly used in red lipstick. The other items in the film studio (3)\_\_\_\_\_used animal fats during their manufacturing. The actors who (4)\_\_\_\_\_that they are vegan in past interviews are unaware of their indirect involvement in such acts of cruelty against animals. The indirect cruelty against animals does not stop here. For example, the extensive disposal of plastic waste in oceans has made plastic a part of the animal food chain, which is detrimental (5)\_\_\_\_\_our entire ecosystem.

**SubQuestion No : 6**

**Q.6** Select the most appropriate option to fill in blank number 2.

- Ans**
- 1. on
  - 2. to
  - 3. over
  - 4. upon

**Comprehension:**

In the following passage, some words have been deleted. Read the passage carefully and select the most appropriate option to fill in each blank.

The disclaimer read that no animals were harmed (1)\_\_\_\_\_the filming of that scene. However, they forgot that the brand of lipstick that was applied (2)\_\_\_\_\_the heroines lips for that scene was manufactured from crushed cochineal bugs, which release a pigment commonly used in red lipstick. The other items in the film studio (3)\_\_\_\_\_used animal fats during their manufacturing. The actors who (4)\_\_\_\_\_that they are vegan in past interviews are unaware of their indirect involvement in such acts of cruelty against animals. The indirect cruelty against animals does not stop here. For example, the extensive disposal of plastic waste in oceans has made plastic a part of the animal food chain, which is detrimental (5)\_\_\_\_\_our entire ecosystem.

**SubQuestion No : 7**

**Q.7** Select the most appropriate option to fill in blank number 3.

- Ans**
- 1. long
  - 2. also
  - 3. least
  - 4. too

**Comprehension:**

In the following passage, some words have been deleted. Read the passage carefully and select the most appropriate option to fill in each blank.

The disclaimer read that no animals were harmed (1)\_\_\_\_\_the filming of that scene. However, they forgot that the brand of lipstick that was applied (2)\_\_\_\_\_the heroines lips for that scene was manufactured from crushed cochineal bugs, which release a pigment commonly used in red lipstick. The other items in the film studio (3)\_\_\_\_\_used animal fats during their manufacturing. The actors who (4)\_\_\_\_\_that they are vegan in past interviews are unaware of their indirect involvement in such acts of cruelty against animals. The indirect cruelty against animals does not stop here. For example, the extensive disposal of plastic waste in oceans has made plastic a part of the animal food chain, which is detrimental (5)\_\_\_\_\_our entire ecosystem.

**SubQuestion No : 8**

**Q.8** Select the most appropriate option to fill in blank number 4.

- Ans**
- 1. were confessing
  - 2. had confessed
  - 3. confessed
  - 4. are confessing

**Comprehension:**

In the following passage, some words have been deleted. Read the passage carefully and select the most appropriate option to fill in each blank.

The disclaimer read that no animals were harmed (1)\_\_\_\_\_the filming of that scene. However, they forgot that the brand of lipstick that was applied (2)\_\_\_\_\_the heroines lips for that scene was manufactured from crushed cochineal bugs, which release a pigment commonly used in red lipstick. The other items in the film studio (3)\_\_\_\_\_used animal fats during their manufacturing. The actors who (4)\_\_\_\_\_that they are vegan in past interviews are unaware of their indirect involvement in such acts of cruelty against animals. The indirect cruelty against animals does not stop here. For example, the extensive disposal of plastic waste in oceans has made plastic a part of the animal food chain, which is detrimental (5)\_\_\_\_\_our entire ecosystem.

**SubQuestion No : 9**

**Q.9** Select the most appropriate option to fill in blank number 5.

- Ans**
- 1. to
  - 2. on
  - 3. in
  - 4. for

**Q.10** Select the most appropriate ANTONYM of the underlined word in the sentence.  
She was asked by the elders to wear a skirt covering her knees.

- Ans**
- 1. Exposing
  - 2. Expanding
  - 3. Expecting
  - 4. Expounding

**Q.11** Select the most appropriate ANTONYM of the underlined word in the given sentence.  
The company has to be able to compete globally.

- Ans**
- 1. Support
  - 2. Attack
  - 3. Pervert
  - 4. Impede

**Q.12** Select the INCORRECTLY spelt word.

- Ans**
- 1. Dissociation
  - 2. Clandestine
  - 3. Pronunciation
  - 4. Denunciation

Q.13 Select the most appropriate option that can substitute the underlined word in the given sentence.  
There was enough room in the spacious flat for all of our furniture.

- Ans
- 1. tiny
  - 2. cozy
  - 3. roomy
  - 4. cramped

Q.14 Select the most appropriate ANTONYM of the underlined word.  
The army advanced into enemy territory.

- Ans
- 1. Protruded
  - 2. Retreated
  - 3. Arose
  - 4. Commuted

Q.15 Which of the following sentences contains the ANTONYM of the word 'important'?

- Ans
- 1. You always make me do all the trivial stuff.
  - 2. Choose the right colour to make your bike stand out!
  - 3. Namita also makes some very salient points in her newly revised preface.
  - 4. I have some urgent questions for you.

Q.16 Select the most appropriate option that can substitute the underlined word in the following sentence.  
If it is sunny tomorrow, we go for a picnic.

- Ans
- 1. will going
  - 2. will went
  - 3. will go
  - 4. goes

Q.17 Select the correct spelling of the underlined word in the following sentence.  
I am in a hurry so I will see you tomorrow.

- Ans
- 1. tomoorow
  - 2. tomorrow
  - 3. toomorow
  - 4. tomoorow

Q.18 Read the given sentence carefully. Change the meaning of the sentence by replacing the underlined word with its ANTONYM from the following options.

William Shakespeare is considered to be the most celebrated dramatist in the world of literature.

- Ans
- 1. laureate
  - 2. acclaimed
  - 3. inglorious
  - 4. illustrious

Q.19 Select the option that will improve the underlined part of the given sentence.

It is my custom to get up early in the morning.

- Ans
- 1. addiction
  - 2. perfection
  - 3. oddity
  - 4. habit

Q.20 Select the most appropriate option to fill in the blank.  
The teacher asked the students to \_\_\_\_\_ attention towards the instructions given for the project.

- Ans
- 1. make
  - 2. keen
  - 3. had
  - 4. pay

Q.21 Select the most appropriate option to substitute the underlined segment in the following sentence.

A gift from my teacher on the eve of the new year was a complete surprise.

- Ans
- 1. like a cat on hot bricks
  - 2. a bolt from the blue
  - 3. like striking one's colours
  - 4. spilling of beans

Q.22 Select the appropriate option that can substitute the underlined phrase in the following sentence.  
Even though she's a celebrity, she doesn't draw any attention towards herself .

- Ans
- 1. is hard to come by
  - 2. keeps a low profile
  - 3. keeps hot under the collar
  - 4. keeps up with the Joneses

Q.23 Select the most appropriate option that can substitute the underlined segment in the given sentence. If there is no need to substitute it, select 'No substitution required'.  
There is an old rivalry between the three families for ages.

- Ans
- 1. of the three families
  - 2. No substitution required
  - 3. among the three families
  - 4. in the three families

Q.24 Select the most appropriate ANTONYM of the given word  
Abundance

- Ans
- 1. Fortune
  - 2. Excitement
  - 3. Scarcity
  - 4. Prosperity

Q.25 Identify the most appropriate synonym of the following word.  
Sceptical

- Ans
- 1. Incredulous
  - 2. Stoic
  - 3. Garrulous
  - 4. Insensitive

Q.1 How many rectangles are there in the given figure?

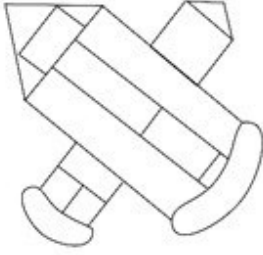

- Ans
- 1. 5
  - 2. 7
  - 3. 8
  - 4. 6

2. JNLO is related to ILIK in a certain way based on the English alphabetical order. In the same way, NRPS is related to MPMO. To which of the following is LPNQ related, following the same logic?

- Ans
- 1. KMKN
  - 2. KNKM
  - 3. KOKM
  - 4. KMKO

Adda247 Marathi

Q.3 Select the option in which the given figure (X) is embedded. (Rotation is NOT allowed).



Ans

1.

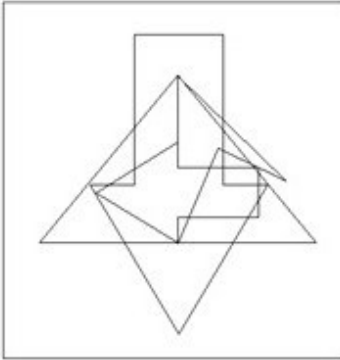

2.



3.

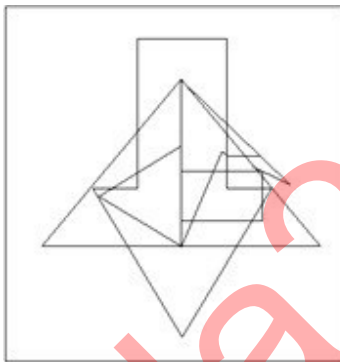

4.

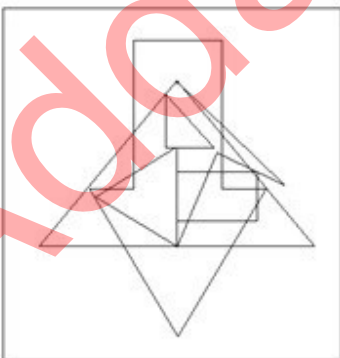

Q.4 What will come in the place of '?' in the following equation, if '+' and '-' are interchanged?

$$47 + 10 \times 3 - 32 \div 8 = ?$$

Ans  1. 19

2. 27

3. 31

4. 21



**Q.5** Select the set in which the numbers are related in the same way as are the numbers of the following sets.  
 (NOTE: Operations should be performed on the whole numbers, without breaking down the numbers into its constituent digits. E.g. 13 – Operations on 13 such as adding/subtracting/multiplying etc. to 13 can be performed. Breaking down 13 into 1 and 3 and then performing mathematical operations on 1 and 3 is not allowed.)  
 (2, 3, 36)  
 (1, 7, 49)

- Ans**
- 1. (4, 4, 252)
  - 2. (3, 5, 225)
  - 3. (5, 4, 260)
  - 4. (1, 9, 59)

**Q.6** Identify the figure given in the options that when put in place of the question mark (?) will logically complete the series.

B 6	V ↑	N 3	↑ V	
↑ V	6 B	V ↑	3 N	?
O	N N	O 6	B B	6

**Ans**

1.

B 6
↑ V
3 N

2.

6 V
B ↑
3 T

3.

3 T
B V
↑ N

4.

B T
↑ V
3 N

**Q.7** What should come in place of the question mark (?) in the given series based on the English alphabetical order?  
 GDJ, KHN, OLR, SPV, ?

- Ans**
- 1. WUZ
  - 2. VSX
  - 3. VTY
  - 4. WTZ

Q.8 In a certain code language, 'BILLION' is coded as '3264581' and 'MILLION' is coded as '3249581'. What is the code for 'M' in that language?

- Ans
- 1. 6
  - 2. 9
  - 3. 3
  - 4. 5

Q.9 What should come in place of the question mark (?) in the given series?

69, 78, 103, 152, ?

- Ans
- 1. 323
  - 2. 332
  - 3. 231
  - 4. 233

Q.10 Select the option that is related to the third number in the same way as the second number is related to the first number.  
10 : 26 :: 50 : ?

- Ans
- 1. 344
  - 2. 343
  - 3. 342
  - 4. 341

Q.11 Based on the alphabetical order, three of the following four letter-clusters are alike in a certain way and thus form a group. Which letter-cluster does not belong to that group?  
(Note: The odd one out is not based on the number of consonants/vowels or their position in the letter cluster.)

- Ans
- 1. PMO
  - 2. EBD
  - 3. ROS
  - 4. LIK

Q.12 What should come in place of the question mark (?) in the given series?

24, 40, 56, 72, ?, 104

- Ans
- 1. 86
  - 2. 87
  - 3. 88
  - 4. 89

Q.13 In a certain code language,  
'A + B' means 'A is the sister of B',  
'A - B' means 'A is the brother of B',  
'A × B' means 'A is the father of B',  
'A ÷ B' means 'A is the wife of B'.  
Based on the above, how is P related to T if 'P + Q ÷ R × S - T'?

- Ans
- 1. Father's sister
  - 2. Mother's sister
  - 3. Mother
  - 4. Sister

Q.14 If 'Y' stands for '+', 'N' stands for '×', 'M' stands for '+' and 'G' stands for '-', what will come in place of the question mark (?) in the following equation?  
100 N 80 G 40 Y 20 M 10 = ?

- Ans
- 1. 8008
  - 2. 5776
  - 3. 8976
  - 4. 987

Q.15 If 19 February 2004 was a Thursday, then what was the day of the week on 2 March 2019?

- Ans
- 1. Friday
  - 2. Thursday
  - 3. Saturday
  - 4. Monday

Q.16 What would be the number on the opposite side of '16' if the given sheet is folded to form a cube?

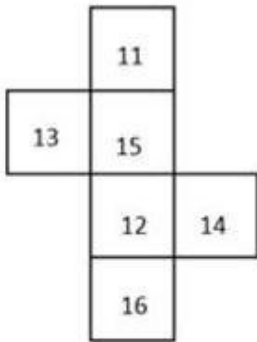

- Ans
- 1. 15
  - 2. 14
  - 3. 13
  - 4. 11

Q.17 Select the combination of letters that when sequentially placed in the blanks of the given series will complete the series.

ABC\_C\_CC\_DCBG\_CA

- Ans
- 1. DCEE
  - 2. DCED
  - 3. EDCE
  - 4. ECDC

Q.18 Select the correct mirror image of the given figure when the mirror is placed at MN as shown below.

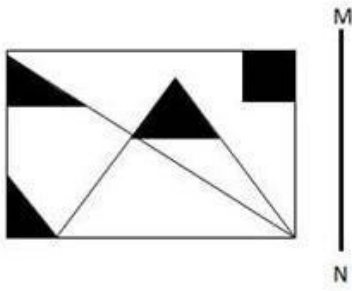

Ans

✓ 1.

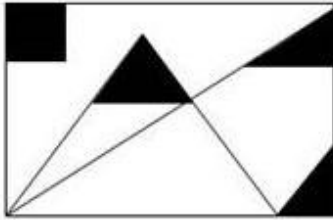

✗ 2.

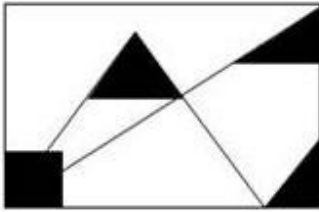

✗ 3.

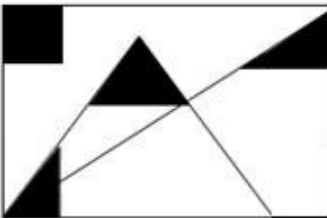

✗ 4.

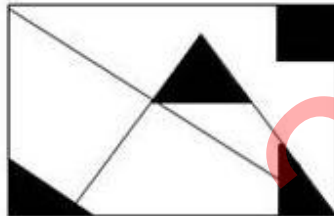

Q.19 Six letters E, J, K, L, M and P are written on different faces of a dice. Two positions of this dice are shown in the figure. Which is the letter on the face opposite to the face containing M?



Ans

✗ 1. P

✗ 2. K

✓ 3. J

✗ 4. E

Q.20 Select the option in which the given figure (X) is embedded. (Rotation is NOT allowed).



Ans

✗ 1.



✓ 2.



✗ 3.



✗ 4.



Q.21 Select the word-pair that best represents a similar relationship to the one expressed in the pair of words given below.

(The words must be considered as meaningful English words and must not be related to each other based on the number of letters/number of consonants/vowels in the word)

Engage : Involve

Ans

✗ 1. Secure : Vulnerable

✗ 2. Entirety : Fragment

✗ 3. Shrink : Grow

✓ 4. Diverse : Varied

Q.22 Which of the following numbers will replace the question mark (?) in the given series?

41 49 65 89 121 161 ?

Ans

✓ 1. 209

✗ 2. 189

✗ 3. 195

✗ 4. 215

Q.23 The position of how many letters will remain unchanged if each of the letters in the word ENGLISH is arranged in alphabetical order?

Ans

✗ 1. Two

✗ 2. Four

✗ 3. Three

✓ 4. One

Q.24 Read the given statements and conclusions carefully. Assuming that the information given in the statements is true, even if it appears to be at variance with commonly known facts, decide which of the given conclusions logically follow(s) from the statements.

Statements:

All papers are charts.

Some charts are notebooks.

Some notebooks are files.

Conclusions:

(I) Some charts are files.

(II) All papers being notebooks is a possibility.

- Ans
- ✓ 1. Only conclusion II follows
  - ✗ 2. Only conclusion I follows
  - ✗ 3. None of the conclusions follow
  - ✗ 4. Both conclusions I and II follow

Q.25 What will come in the place of the question mark (?) in the following equation, if '+' and '-' are interchanged and '×' and '÷' are interchanged?

$$20 - 80 \times 16 \div 5 + 15 = ?$$

- Ans
- ✗ 1. 35
  - ✗ 2. 32
  - ✗ 3. 36
  - ✓ 4. 30

Section : Quantitative Aptitude

Q.1 The following graph shows the demand and production of buses of five companies in 2022 (in thousands). Study the given graph carefully and answer the question that follows

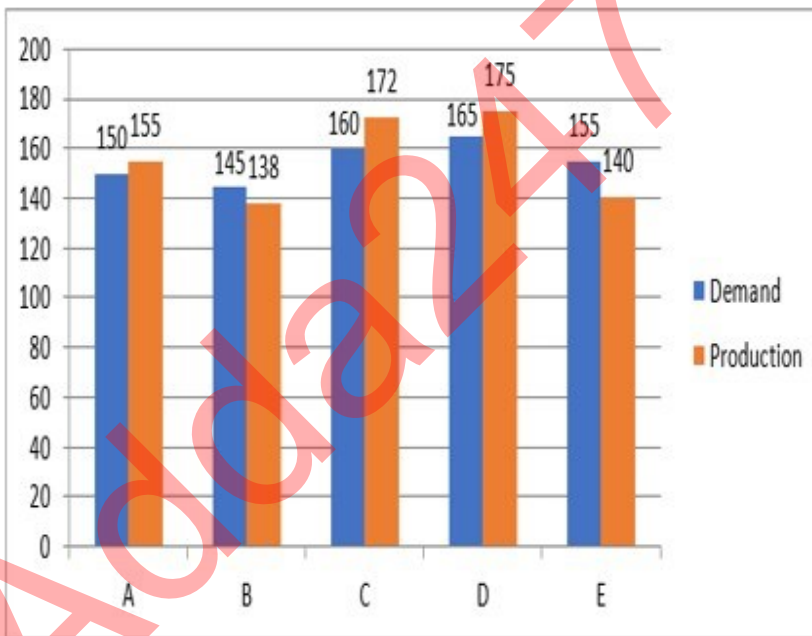

The number of companies whose production of buses is equal to or more than the average demand of buses of all five companies is:

- Ans
- ✓ 1. 3
  - ✗ 2. 1
  - ✗ 3. 4
  - ✗ 4. 2

Q.2 The length of a rectangular shaped park exceeds its breadth by 15 m. If the perimeter of the park is 110 m, find the length of the park (in m).

- Ans
- 1. 20
  - 2. 35
  - 3. 25
  - 4. 40

Q.3 The marked price of an item is 1.4 times the cost price. In order to earn 23.2% profit, what per cent discount can a shopkeeper allow?

- Ans
- 1. 13%
  - 2. 17%
  - 3. 15%
  - 4. 12%

Q.4 The hypotenuse of a right triangle is 6m more than twice the shortest side. If the third side is 2 m less than the hypotenuse, find the area(in  $m^2$ ) of the triangle.

- Ans
- 1. 130
  - 2. 100
  - 3. 120
  - 4. 110

Q.5 In a 2 km linear race, if P completes the race in 200 second and Q in 220 seconds, then the distance by which P beats Q is:

- Ans
- 1.  $167\frac{6}{11}$  metres
  - 2.  $173\frac{7}{11}$  metres
  - 3.  $191\frac{7}{11}$  metres
  - 4.  $181\frac{9}{11}$  metres

Q.6 A trader buys 500 kg cotton for ₹8,000. If 10% of this cotton is spoiled due to rain, at what rate (₹/kg) should he sell the rest to earn a 20% profit?

- Ans
- 1.  $21\frac{1}{3}$
  - 2.  $22\frac{1}{3}$
  - 3.  $25\frac{1}{3}$
  - 4.  $23\frac{1}{3}$

Q.7 Rohan can alone finish a work in 12 days and Hari can alone in 16 days. They both work for 3 days and then Rohan left. After that only Hari works and finishes the work. The total work will be completed in:

- Ans
- 1. 12 days
  - 2.  $12\frac{2}{3}$  days
  - 3. 9 days
  - 4.  $12\frac{1}{3}$  days

Q.8 A person saves 45% of his income. Next year, his income increases by 200%. He increases his savings by five times the previous year's savings. By what percentage (correct to one place of decimal) has he increased/decreased his expenditure?

- Ans
- 1. Decreased, 63.4%
  - 2. Decreased, 36.4%
  - 3. Increased, 63.4%
  - 4. Increased, 36.4%

Q.9 In what proportion must tea worth ₹27 and ₹31 per kg be mixed so as to gain 25% by selling the mixture at ₹36 per kg?

- Ans
- 1. 3 : 7
  - 2. 2 : 11
  - 3. 11 : 9
  - 4. 9 : 11

Q.10 In a circle, the chords AB and CD intersect each other at point L (internally). If AL = 9 cm, LB = 7 cm and LD = 3 cm, then find CL (in cm).

- Ans
- 1. 20
  - 2. 21
  - 3. 18
  - 4. 19

Q.11 The table shows the percentage distribution of the population (only male and female) according to Gender and Literacy.

State	Percentage literate	Gender	
		Literate	Illiterate
		M : F	M : F
A	55	5 : 6	4 : 5
B	72	1 : 1	3 : 2
C	78	4 : 3	3 : 2

The total population in state C, if the illiterate female count in state C is 4,40,000, is:

- Ans
- 1. 3600000
  - 2. 5000000
  - 3. 6000000
  - 4. 4600000

Q.12 In how much time (in years) will ₹7,200 amount to ₹8,928 at simple interest at the rate of 8% per annum?

- Ans
- 1. 3
  - 2. 2
  - 3. 5
  - 4. 4

Q.13 If 6428A83 is divisible by 9, then the value of A is equal to :

- Ans
- 1. 6
  - 2. 7
  - 3. 5
  - 4. 3



Q.14 A natural number  $n$  divides 732 and leaves 12 as a remainder. How many values of  $n$  are possible?

- Ans
- 1. 18
  - 2. 20
  - 3. 16
  - 4. 22

Q.15 If lateral surface area of a cube is  $144 \text{ cm}^2$ , then find its volume.

- Ans
- 1.  $216 \text{ cm}^3$
  - 2.  $117.58 \text{ cm}^3$
  - 3.  $1728 \text{ cm}^3$
  - 4.  $864 \text{ cm}^3$

Q.16 If  $\cot \alpha = \frac{P}{Q}$ , then find the value of  $\frac{P \cos \alpha - Q \sin \alpha}{P \cos \alpha + Q \sin \alpha} - \frac{P^2 - Q^2}{P^2 + Q^2} + 3$ .

- Ans
- 1.  $\frac{P^2}{P^2 + Q^2}$
  - 2.  $\frac{P}{Q}$
  - 3. 0
  - 4. 3

Q.17 A cylinder has a curved surface area equal to 350% of the curved surface area of another cylinder. If their radii are in the ratio 3 : 1, then the volume of the smaller cylinder is approximately \_\_\_\_\_% of the larger cylinder (the smaller cylinder has its radius and height smaller when compared to the larger).

- Ans
- 1. 9.52
  - 2. 8.86
  - 3. 7.28
  - 4. 10.16

Q.18 Find the length of the sides of a triangle, if its angles are in the ratio 2 : 4 : 6 and its circumradius is 12 cm.

- Ans
- 1. 5 cm, 6 cm, 10 cm
  - 2. 15 cm,  $15\sqrt{3}$  cm, 30 cm
  - 3. 12 cm,  $12\sqrt{3}$  cm, 24 cm
  - 4. 6 cm,  $6\sqrt{3}$  cm, 12 cm

Q.19 A bigger circle centre at O and a smaller circle centre at P touch each other externally such that the length of their common tangent LM is 12 cm. If the radius of the bigger circle is 18 cm, then what will be the radius (in cm) of the smaller circle?

- Ans
- 1. 4
  - 2. 3
  - 3. 2
  - 4. 1

Q.20

A battery manufacturer manufactures five different types of batteries. The total revenue for the year 2020 is ₹25,00,000 and 20,000 units were exported in 2020. The distribution of revenue and units for the five different types of batteries is shown in the charts.



Which type of the battery provides the highest revenue per unit of export?

- Ans
- 1. M-Air
  - 2. Li-ion
  - 3. Sodium
  - 4. Lead acid

Q.21 In an election between two candidates, 10% of the voters did not cast their votes and 5% of the votes polled were found invalid. The successful candidate got 52.5% of the valid votes and won by a majority of 1710 votes. The number of voters enrolled on the voters list was:

- Ans
- 1. 36000
  - 2. 40000
  - 3. 42000
  - 4. 48000

Q.22 A covered wooden box has the inner measures as 128 cm, 90 cm, 25 cm and the thickness of wood is 5.5 cm. Find the volume of the wood.

- Ans
- 1. 329431 cm<sup>3</sup>
  - 2. 217404 cm<sup>3</sup>
  - 3. 819832 cm<sup>3</sup>
  - 4. 192392 cm<sup>3</sup>

Q.23 Two numbers are, respectively, 30% and 60% more than a third number. The ratio of the two numbers is:

- Ans
- 1. 13 : 17
  - 2. 12 : 13
  - 3. 11 : 15
  - 4. 13 : 16

Q.24 If the areas of three adjacent faces of a cuboid are  $5 \text{ cm}^2$ ,  $15 \text{ cm}^2$ ,  $27 \text{ cm}^2$ , respectively, the surface area of the cuboid is:

- Ans
- 1.  $1.45 \text{ cm}^2$
  - 2.  $2.75 \text{ cm}^2$
  - 3.  $3.47 \text{ cm}^2$
  - 4.  $94 \text{ cm}^2$

Q.25 Answer the following question on the basis of the bar graph given.

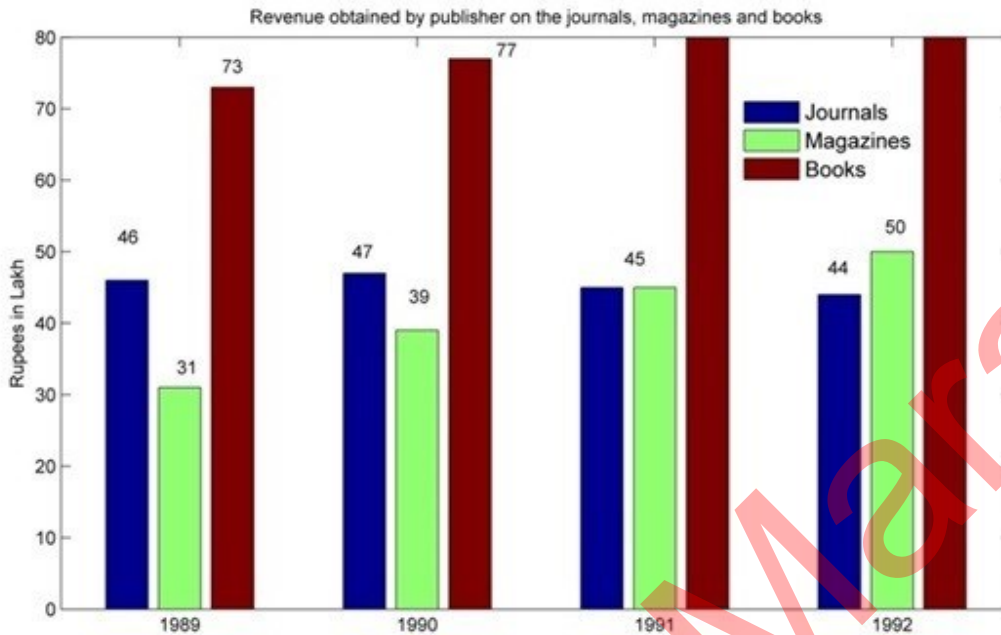

The number of years in which there was an increase in the revenue from at least two categories is:

- Ans
- 1. 1
  - 2. 3
  - 3. 4
  - 4. 2

Section : General Awareness

Q.1 According to the Census of India-2011, what is the sex ratio (Females per 1000 males) of India?

- Ans
- 1. 933
  - 2. 927
  - 3. 943
  - 4. 934

2. Who calculated the approximate location of the planet Neptune by studying gravity-induced disturbances in the motion of Uranus?

- Ans
- 1. John Couch Adams
  - 2. Johann Gottfried Galle
  - 3. Urbain-Jean-Joseph Le Verrier
  - 4. Percival Lowell

Q.3 In which year was MS Dhoni awarded Padma Shri Award?

- Ans
- 1. 2010
  - 2. 2012
  - 3. 2007
  - 4. 2009

Q.4 What was India's population growth rate (in percentage) during 2001-2011?

- Ans
- 1. 23.87%
  - 2. 17.64%
  - 3. 24.66%
  - 4. 21.54%

Q.5 Where can you find the options 'From Beginning' and 'From Current Slide' to run a slide show in MS PowerPoint?

- Ans
- 1. Home tab
  - 2. Slide Show tab
  - 3. Slide Sorter tab
  - 4. View tab

Q.6 Which of the following refers to the purchase and sale of government securities?

- Ans
- 1. Bank rate
  - 2. Open market operations
  - 3. Reserve ratio
  - 4. High powered money

Q.7 Which Act opposed by Mahatma Gandhi in 1919 was a direct attack on the civil liberties and democratic rights of the Indian people?

- Ans
- 1. Criminal Tribes Act
  - 2. Defence of India Act
  - 3. Pitt's India Act
  - 4. Rowlatt Act

Q.8 Which of the following organisations said that India CANNOT have a parallel judicial system - one for the rich and the other for the poor?

- Ans
- 1. Supreme Court
  - 2. Himachal High Court
  - 3. Gujarat High Court
  - 4. Kerala High Court

Q.9 Oil India Limited (OIL) is under the administrative structure of:

- Ans
- 1. Ministry of Petroleum and Natural Gas
  - 2. Ministry of Power
  - 3. Ministry of Commerce and Industry
  - 4. Ministry of New and Renewable Energy

Q.10 The number of white pawns in chess is \_\_\_\_\_.

- Ans
- 1. 10
  - 2. 12
  - 3. 8
  - 4. 14

Q.11 On the 74<sup>th</sup> republic day of India, President of Egypt, \_\_\_\_\_ was the Chief Guest at the Republic Day parade.

- Ans
- 1. Gamal Abdel Nasser Husain
  - 2. Abdel Fattah El-Sisi
  - 3. Muhammad Hosni El Sayed Mubarak
  - 4. Adly Mahmoud Mansour

Q.12 Who is known as the Father of Modern Dance in India?

- Ans
- 1. Kelucharan Mohapatra
  - 2. Uday Shankar
  - 3. Pandit Birju Maharaj
  - 4. Atombapu Sharma

Q.13 Which of the following is called the cyclic arrangement of time units in Hindustani Classical music?

- Ans
- 1. Alap
  - 2. Raga
  - 3. Tala
  - 4. Jati

Q.14 In honey bees, \_\_\_\_\_

- Ans
- 1. males are triploid and females are tetraploid.
  - 2. males are haploid and females are diploid.
  - 3. males are diploid and females are haploid.
  - 4. males are tetraploid and females are triploid.

Q.15 Identify the INCORRECT pair regarding the material media and their refractive index?

- Ans
- 1. Sapphire – 1.77
  - 2. Kerosene – 1.44
  - 3. Ruby – 1.71
  - 4. Benzene – 2.42

Q.16 The Preamble of the Constitution describes India as:

- Ans
- 1. a unitary state
  - 2. a federal state
  - 3. an atheist state
  - 4. a secular state

Q.17 Which of the following is a style of Carnatic music?

- Ans
- 1. Svarajati
  - 2. Chaturang
  - 3. Dhamar
  - 4. Dhruvad

Q.18 Which of the following rivers is called 'Singi Khamban' in Tibet?

- Ans
- 1. Brahmaputra
  - 2. Sutlej
  - 3. Kosi
  - 4. Indus

Q.19 Judicial Review, a salient feature of the Constitution of India, has been borrowed from which of the following countries?

- Ans
- 1. South Africa
  - 2. Canada
  - 3. Ireland
  - 4. The US

**Q.20** Which of the following statements are true about the positive impact of the Green Revolution (GR) on yield levels in India?

- i. During the post GR period, the yield of rice grew at a much faster rate than that of wheat.
- ii. GR technology had penetrated more in wheat crop than in the rice crop.
- iii. During post GR period, the area under rice achieved a relatively slow growth when compared to the area under wheat.

- Ans**
- 1. Only ii and iii
  - 2. i, ii and iii
  - 3. Only i and ii
  - 4. Only i and iii

**Q.21** In which year was the All India Football Federation (AIFF) formed?

- Ans**
- 1. 1947
  - 2. 1967
  - 3. 1957
  - 4. 1937

**Q.22** The Press and Periodicals Registration Bill, 2023 replaced which act with a simplified law that decriminalizes various provisions and brings digital media under its ambit?

- Ans**
- 1. Censorship of Press Act, 1799
  - 2. Newspaper (Incitement to Offences) Act, 1908
  - 3. Press (Objectionable Matters) Act, 1951
  - 4. Press and Registration of Books Act, 1867

**Q.23** The founder of the Pallava dynasty was:

- Ans**
- 1. Singhamvishnu
  - 2. Simhavishnu
  - 3. Simharaj
  - 4. Balasimha

**Q.24** In November 2022, the Supreme Court upheld the 10% reservation of EWS quota. This EWS reservation was granted on the basis of recommendations from which of the following commissions?

- Ans**
- 1. Sarkaria commission
  - 2. Kelkar commission
  - 3. Mandal commission
  - 4. Sinho commission

**Q.25** What should you click to choose the date for sorting in Gmail?

- Ans**
- 1. The calendar icon
  - 2. The '1 Day' dropdown menu
  - 3. The 'Date within' field
  - 4. The filter icon

## Combined Higher Secondary Level Examination 2024 Tier I

Exam Date	09/07/2024
Exam Time	11:45 AM - 12:45 PM
Subject	CHSL Exam 2024 Tier I

### Section : English Language

1. Identify the error in the given sentence and select the correct sentence from the given options.  
This is the story of eight round planets, the few rocks in between, and some comets.

Ans  1. This is story of eight round planets, few rocks in between, and some comets.  
 2. This is a story of eight round planets, few rocks in between, and some comets.  
 3. This is the story of eight round planets, few rocks in between, and some comets.  
 4. This is the story of eight round planets, a few rocks in between, and some comets.

2. The following sentence has been split into four segments. Identify the segment that contains a grammatical error.

Everyone have/ to join health orientation/ classes before/ going for trekking.

Ans  1. to join health orientation  
 2. Everyone have  
 3. going for trekking  
 4. classes before

3. The following sentence has been split into four segments. Identify the segment that contains a grammatical error. Our plane / arrived at / the Mumbai airport / at the right time.

Ans  1. arrived at  
 2. Our plane  
 3. at the right time  
 4. the Mumbai airport

- Q.4 The following sentence has been split into four segments. Identify the segment that contains a grammatical error. It was noticed / that he truthful / answered the questions / raised by the Headmistress.

Ans  1. that he truthful  
 2. It was noticed  
 3. raised by the Headmistress.  
 4. answered the questions

**Comprehension:**

In the following passage, some words have been deleted. Select the most appropriate option to fill in the blanks.

Our country, India, is one of the 12 mega bio-diversity countries of the world. With about 47,000 plant species, India (1)\_\_\_\_\_tenth place in the world and fourth in Asia in plant diversity. There are (2)\_\_\_\_\_15,000 flowering plants in India, which account for 6 per cent of the world's (3)\_\_\_\_\_number of flowering plants. The country has many non-flowering plants, (4)\_\_\_\_\_as ferns, algae and fungi. India also has approximately 90,000 (5)\_\_\_\_\_of animals, as well as a rich variety of fish in its fresh and marine waters.

**SubQuestion No : 5**

**Q.5** Select the most appropriate option to fill in blank number 1.

- Ans
- 1. have
  - 2. occupies
  - 3. had
  - 4. occupy

**Comprehension:**

In the following passage, some words have been deleted. Select the most appropriate option to fill in the blanks.

Our country, India, is one of the 12 mega bio-diversity countries of the world. With about 47,000 plant species, India (1)\_\_\_\_\_tenth place in the world and fourth in Asia in plant diversity. There are (2)\_\_\_\_\_15,000 flowering plants in India, which account for 6 per cent of the world's (3)\_\_\_\_\_number of flowering plants. The country has many non-flowering plants, (4)\_\_\_\_\_as ferns, algae and fungi. India also has approximately 90,000 (5)\_\_\_\_\_of animals, as well as a rich variety of fish in its fresh and marine waters.

**SubQuestion No : 6**

**Q.6** Select the most appropriate option to fill in blank number 2.

- Ans
- 1. a
  - 2. many
  - 3. of
  - 4. about

**Comprehension:**

In the following passage, some words have been deleted. Select the most appropriate option to fill in the blanks.

Our country, India, is one of the 12 mega bio-diversity countries of the world. With about 47,000 plant species, India (1)\_\_\_\_\_tenth place in the world and fourth in Asia in plant diversity. There are (2)\_\_\_\_\_15,000 flowering plants in India, which account for 6 per cent of the world's (3)\_\_\_\_\_number of flowering plants. The country has many non-flowering plants, (4)\_\_\_\_\_as ferns, algae and fungi. India also has approximately 90,000 (5)\_\_\_\_\_of animals, as well as a rich variety of fish in its fresh and marine waters.

**SubQuestion No : 7**

**Q.7** Select the most appropriate option to fill in blank number 3.

- Ans
- 1. exact
  - 2. nearly
  - 3. exactly
  - 4. total

**Comprehension:**

In the following passage, some words have been deleted. Select the most appropriate option to fill in the blanks.

Our country, India, is one of the 12 mega bio-diversity countries of the world. With about 47,000 plant species, India (1)\_\_\_\_\_tenth place in the world and fourth in Asia in plant diversity. There are (2)\_\_\_\_\_15,000 flowering plants in India, which account for 6 per cent of the world's (3)\_\_\_\_\_number of flowering plants. The country has many non-flowering plants, (4)\_\_\_\_\_as ferns, algae and fungi. India also has approximately 90,000 (5)\_\_\_\_\_of animals, as well as a rich variety of fish in its fresh and marine waters.

**SubQuestion No : 8**

**Q.8** Select the most appropriate option to fill in blank number 4.

- Ans
- 1. as
  - 2. such
  - 3. in
  - 4. for



**Comprehension:**

In the following passage, some words have been deleted. Select the most appropriate option to fill in the blanks. Our country, India, is one of the 12 mega bio-diversity countries of the world. With about 47,000 plant species, India (1)\_\_\_\_\_tenth place in the world and fourth in Asia in plant diversity. There are (2)\_\_\_\_\_15,000 flowering plants in India, which account for 6 per cent of the world's (3)\_\_\_\_\_number of flowering plants. The country has many non-flowering plants, (4)\_\_\_\_\_as ferns, algae and fungi. India also has approximately 90,000 (5)\_\_\_\_\_of animals, as well as a rich variety of fish in its fresh and marine waters.

**SubQuestion No : 9**

**Q.9** Select the most appropriate option to fill in blank number 5.

- Ans
- 1. specie
  - 2. species
  - 3. kind
  - 4. type

**Q.10** Select the most appropriate option that can substitute the underlined segment in the given sentence. She finished her quickly breakfast and rushed to school.

- Ans
- 1. finished her breakfast quickly
  - 2. quickly her breakfast finished
  - 3. her breakfast finished quickly
  - 4. finished breakfast hers quickly

**Q.11** Select the most appropriate ANTONYM of the bracketed word in the following sentence to fill in the blank. Lewis was aggressive, \_\_\_\_\_(normal), moody, and brilliantly clever.

- Ans
- 1. feeble
  - 2. eccentric
  - 3. dogmatic
  - 4. selfish

**Q.12** Select the most appropriate option to fill in the blank. I am scared of snakes; likewise, you are \_\_\_\_\_of lizards.

- Ans
- 1. passionate
  - 2. critical
  - 3. fond
  - 4. fearful

**Q.13** Select the option that can substitute the bracketed word segment meaningfully. Writing can instil a number of emotions (as in a reader).

- Ans
- 1. until a reader
  - 2. among a reader
  - 3. within a reader
  - 4. instead a reader

**Q.14** Select the sentence which gives the most appropriate meaning of the given idiom. A piece of cake

- Ans
- 1. Despite the heavy rain, they managed to have a successful outdoor event.
  - 2. The restaurant was crowded, but they found a table without any difficulty.
  - 3. The puzzle was so challenging that it took hours for Sam to solve it.
  - 4. After months of practice, Emily performed her piano piece flawlessly during the concert.

**Q.15** Select the most appropriate synonym of the given word. Attire

- Ans
- 1. Park
  - 2. Dress
  - 3. Theatre
  - 4. Hotel

Q.16 Select the most appropriate ANTONYM of the underlined word in the given sentence.  
The dog was agitated and bit the child.

- Ans
- 1. steady
  - 2. nerveless
  - 3. quiescent
  - 4. serene

Q.17 There is a spelling error in the given sentence. Select the option that contains the INCORRECTLY spelt word.  
He was thrilled when he heard about there journey to wonderland.

- Ans
- 1. journey
  - 2. thrilled
  - 3. there
  - 4. heard

Q.18 Select the most appropriate option to fill in the blank.

I have observed that there is proper natural \_\_\_\_\_ even at 6 o'clock on summer mornings.

- Ans
- 1. light
  - 2. sparkle
  - 3. lucent
  - 4. gleam

Q.19 Select the most appropriate synonym of the given word.

Hypocrisy

- Ans
- 1. Harm
  - 2. Sincerity
  - 3. Deceit
  - 4. Truth

Q.20 Select the most appropriate synonym of the given word.

Bliss

- Ans
- 1. Consecration
  - 2. Pleasure
  - 3. Genesis
  - 4. Avail

Q.21 Select the most appropriate option that can substitute the underlined words in the following sentence.  
I consider that every matter must be considered in every point of view.

- Ans
- 1. of every point
  - 2. from every point
  - 3. at every point
  - 4. on every point

Q.22 Select the INCORRECTLY spelt word.

- Ans
- 1. Condimnation
  - 2. Intermingled
  - 3. Imprisonment
  - 4. Conglomerate

Q.23 Select the most appropriate synonym of the underlined word.  
The sun was shining bright and intense in the sky.

- Ans
- 1. Mild
  - 2. Strong
  - 3. Subtle
  - 4. Weak

Q.24 Select the most appropriate meaning of the given idiom.

Under the weather

- Ans
- 1. To feel secure
  - 2. To enjoy the weather
  - 3. To feel unwell
  - 4. To work against the weather

Q.25 Select the most appropriate option that can substitute the underlined segment in the given sentence.  
Once bitten, thrice shy.

- Ans
- 1. always shy
  - 2. never shy
  - 3. once shy
  - 4. twice shy

Section : General Intelligence

Q.1 What should come in place of the question mark (?) in the given series?  
58, 73, 90, 109, ?

- Ans
- 1. 103
  - 2. 310
  - 3. 301
  - 4. 130

2. Based on the alphabetical order, three of the following four letter-clusters are alike in a certain way and thus form a group.  
Which letter-cluster does not belong to that group?  
(Note: The odd one out is not based on the number of consonants/vowels or their position in the letter cluster.)

- Ans
- 1. ILO
  - 2. NQU
  - 3. DGK
  - 4. JMQ

Q.3 A paper is folded and cut as shown below. How will it appear when unfolded?

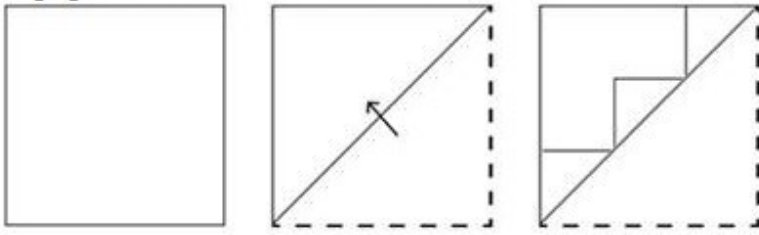

Ans

✗ 1.

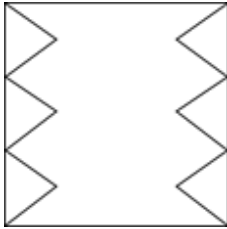

✓ 2.

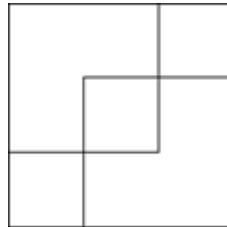

✗ 3.

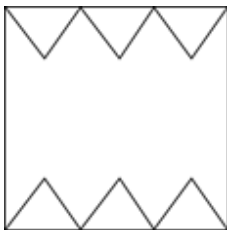

✗ 4.

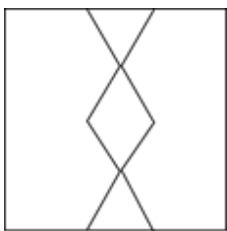

Q.4 Three statements are followed by conclusions numbered I, II. You have to consider these statements to be true, even if they seem to be at variance with commonly known facts. Decide which of the given conclusions logically follow/s from the given statement.

Statements:

All dresses are clouds.

Some clouds are tables.

Some tables are stones.

Conclusion (I): All stones are dresses.

Conclusion (II): Some dresses are tables.

Ans ✓ 1. Neither conclusion (I) nor (II) follows.

✗ 2. Only conclusion (I) follows.

✗ 3. Only conclusion (II) follows.

✗ 4. Both conclusions (I) and (II) follow.

Q.5 What should come in place of the question mark (?) in the given series based on the English alphabetical order?  
ACW, FHB, KMG, PRL, ?

Ans ✗ 1. UQW

✓ 2. UWQ

✗ 3. VQW

✗ 4. VWQ

Q.6  $\left[\frac{17}{41}\right]$  is related to  $\left[\frac{34}{41}\right]$  following a certain logic. Following the same logic,  $\left[\frac{11}{85}\right]$  is related to  $\left[\frac{22}{85}\right]$ . To which of the following is  $\left[\frac{13}{77}\right]$  related, following the same logic?

(NOTE: Operations should be performed on the whole numbers, without breaking down the numbers into its constituent digits. E.g. 13 – Operations on 13 such as adding/subtracting/multiplying etc. to 13 can be performed. Breaking down 13 into 1 and 3 and then performing mathematical operations on 1 and 3 is not allowed.)

- Ans
- 1.  $\left[\frac{24}{75}\right]$
  - 2.  $\left[\frac{29}{77}\right]$
  - 3.  $\left[\frac{23}{77}\right]$
  - 4.  $\left[\frac{26}{77}\right]$

Q.7 If 29 July 2001 is Sunday, then what will be the day of the week on 20 February 2015?

- Ans
- 1. Tuesday
  - 2. Friday
  - 3. Sunday
  - 4. Monday

Q.8 In a certain code language, 'get enough sleep' is coded as 'ab de jf' and 'go get it' is coded as 'jk ab gh'. How is 'get' coded in that language?

- Ans
- 1. jk
  - 2. de
  - 3. ab
  - 4. jf

Q.9 'STEM' is related to 'HGVN' in a certain way based on the English alphabetical order. In the same way, 'QUIT' is related to 'JFRG'. To which of the following is 'ACCOUNTABLE' related, following the same logic?

- Ans
- 1. ZXXLFMGZYOV
  - 2. ZXXLFMGZYOU
  - 3. ZXXLFMZGYOV
  - 4. ZXXFLMGZYOV

Q.10 What should come in place of the question mark (?) to complete the following letter-cluster series?  
UME, OPG, ISJ, EVN, ?

- Ans
- 1. AYR
  - 2. BYS
  - 3. AYS
  - 4. AXS

Q.11 Which of the following numbers will replace the question mark (?) in the given series?

$$\left[\frac{37}{5}\right], \left[\frac{32}{5}\right], \left[\frac{27}{5}\right], \left[\frac{22}{5}\right], \left[\frac{17}{5}\right], ?$$

Ans

✓ 1.  $\left[\frac{12}{5}\right]$

✗ 2.  $\left[\frac{9}{5}\right]$

✗ 3.  $\left[\frac{16}{5}\right]$

✗ 4.  $\left[\frac{14}{5}\right]$

Q.12 What will come in the place of the question mark (?) in the following equation, if '+' and '-' are interchanged and '×' and '÷' are interchanged?

$$216 \times 9 + 52 - 7 \div 7 = ?$$

Ans

✗ 1. 20

✗ 2. 22

✓ 3. 21

✗ 4. 19

Q.13 Select the set in which the numbers are related in the same way as are the numbers of the given sets.  
(NOTE: Operations should be performed on the whole numbers, without breaking down the numbers into its constituent digits. E.g., 13 – Operations on 13 such as adding/subtracting/multiplying etc. to 13 can be performed. Breaking down 13 into 1 and 3 and then performing mathematical operations on 1 and 3 is not allowed.)

(180, 45, 90)

(128, 32, 64)

Ans

✗ 1. (248, 60, 124)

✗ 2. (170, 43, 85)

✓ 3. (224, 56, 112)

✗ 4. (186, 46, 93)

Q.14 Select the correct mirror image of the given figure when the mirror is placed at MN.

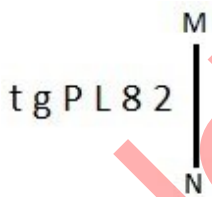

Ans

✗ 1. 2 8 1 d 8 1

✗ 2. 5 8 1 d g t

✗ 3. 2 8 1 9 g t

✓ 4. 5 8 1 9 g t

Q.15 Which of the following numbers will replace the question mark (?) in the given series?

$$7 \quad 13 \quad 39 \quad 46 \quad 138 \quad 146 \quad 438 \quad 447 \quad ?$$

Ans

✗ 1. 1247

✗ 2. 1146

✗ 3. 1138

✓ 4. 1341

Q.16 Select the correct mirror image of the given figure when the mirror is placed at MN as shown below.

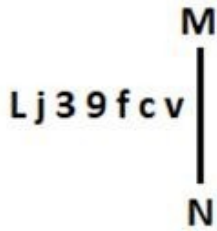

- Ans
- 1. vɔʃeɛjJ
  - 2. vɔʃ39jJ
  - 3. ʌɔʃeɛjJ
  - 4. vɔʃeɛjJ

Q.17 How many triangles are there in the given figure?

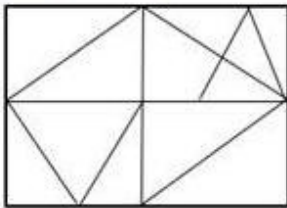

- Ans
- 1. 17
  - 2. 11
  - 3. 10
  - 4. 12

Q.18 If 25 October 2004 was Monday, then what was the day of the week on 2 November 2007?

- Ans
- 1. Friday
  - 2. Saturday
  - 3. Thursday
  - 4. Wednesday

Q.19 In a certain code language  
A + B means 'A is the mother of B'  
A - B means 'A is the brother of B'  
A × B means 'A is the wife of B'  
A ÷ B means 'A is the father of B'  
Based on the above, how is G related to K if 'G + J ÷ H × I - K'?

- Ans
- 1. Brother's wife's sister
  - 2. Brother's wife's mother
  - 3. Brother's wife's father's mother
  - 4. Brother's wife's father's sister

Q.20 Select the word-pair that best represents a similar relationship to the one expressed in the pair of words given below. (The words must be considered as meaningful English words and must not be related to each other based on the number of letters/number of consonants/vowels in the word.)  
Trim : Hair

- Ans
- 1. Prune : Hedge
  - 2. Pluck : Flower
  - 3. Clip : Clothes
  - 4. Harvest : Corn

Q.21 If 'A' stands for '+', 'B' stands for '×', 'C' stands for '÷' and 'D' stands for '−', then the resultant of which of the following will be 428?

- Ans
- 1. 113 A 4 D 62 B 2 C 7
  - 2. 113 B 4 D 62 A 2 C 7
  - 3. 113 B 4 A 62 D 2 C 7
  - 4. 113 B 4 C 62 A 2 D 7

Q.22 What will come in the place of the question mark (?) in the following equation, if '+' and '×' are interchanged and '−' and '÷' are interchanged?

$$98 - 14 \times 11 + 6 \div 23 = ?$$

- Ans
- 1. 50
  - 2. 55
  - 3. 52
  - 4. 56

Q.23 Select the correct mirror image of the given figure when the mirror is placed at MN.

kL5Gre



- Ans
- 1. e12G1k
  - 2. kL5Gre
  - 3. kL5Gre
  - 4. kL5Gre



Q.24 Identify the figure given in the options which when put in place of ? will logically complete the series.

@	#	-	+	
+	@	#	-	?
#	-	+	+	@
		@	@	#

Ans

✗ 1.

@	-
#	+

✗ 2.

#	+
-	@

✓ 3.

@	+
#	-

✗ 4.

-	@
+	#

Adda247 Marathi

Q.25 Select the option figure in which the given figure (X) is embedded as its part (rotation is NOT allowed).

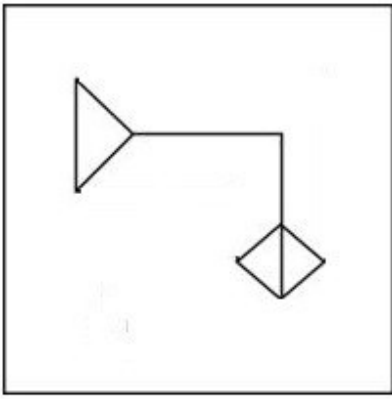

(X)

Ans

✓ 1.

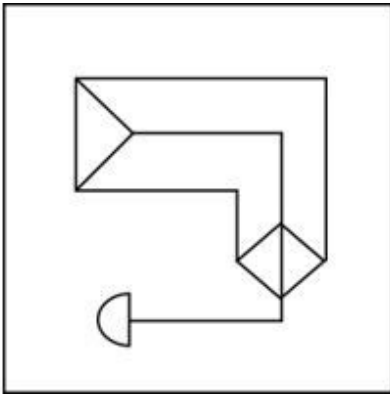

✗ 2.

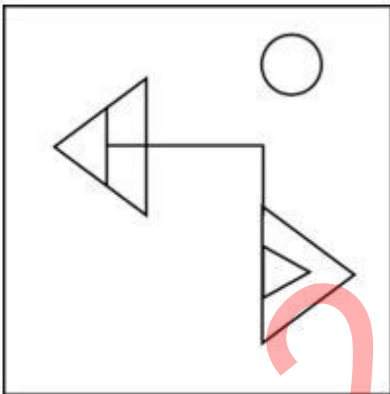

✗ 3.

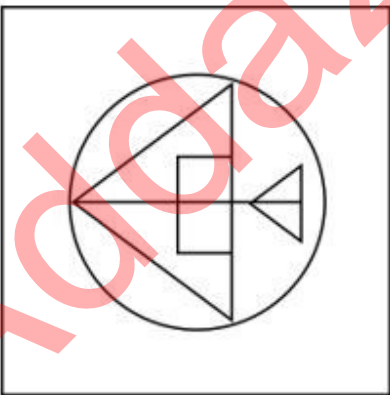

✗ 4.

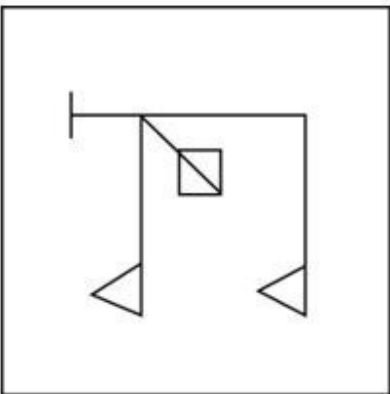

Q.1 If the intersection point of the equations  $3p - 2q + 23 = 0$  and  $-2p + q - 13 = 0$  on the graph is  $(p, q)$ , then the value of  $(3p + q)$  is equal to:

- Ans
- 1. 2
  - 2. 1
  - 3. -2
  - 4. -1

Q.2 The age of a tree depends on the number of rings in the trunk. The value of a such tree is proportional to its age. If a tree with 40 rings and 50 years of age has a value of ₹50,000, then a tree with 30 rings is \_\_\_\_ years of age and its value is ₹\_\_\_\_\_.

- Ans
- 1. 37.5, 57500
  - 2. 37.5, 37500
  - 3. 57.5, 57500
  - 4. 57.5, 37500

Q.3 Simply the following expression.

$$469 \div [270 \div (\frac{3}{7} \times 35) + (19 \times 3) - (\frac{21}{2} - \frac{5}{2})]$$

- Ans
- 1. 7
  - 2. 13
  - 3. 11
  - 4. 9

Q.4 How many cubes of edge 15 cm can be put in a cubical box of 3 m edge?

- Ans
- 1. 9000
  - 2. 1050
  - 3. 8000
  - 4. 2000

Q.5 If a sum of ₹3,260 on simple interest amounts to ₹5,420 in 6 years, then what will this sum amount to in 4 years at the same rate of interest?

- Ans
- 1. ₹4,700
  - 2. ₹3,700
  - 3. ₹3,900
  - 4. ₹4,500

Q.6 If  $\tan \theta = \frac{7}{4}$ , then the value of  $\frac{4 \sin \theta - 3 \cos \theta}{4 \sin \theta + 3 \cos \theta}$  is equal to:

- Ans
- 1.  $\frac{2}{5}$
  - 2.  $\frac{1}{3}$
  - 3.  $\frac{4}{5}$
  - 4.  $\frac{3}{5}$

Q.7 A closed cylindrical tank of radius 1.5 m and height 3 m is made from a sheet of metal, how much sheet of metal is required to do it?

- Ans
- 1. 42.24 square metre
  - 2. 24.42 square metre
  - 3. 42.42 square metre
  - 4. 24.24 square metre

Q.8 The total income of three families is ₹72,000. Their expenditures are 80%, 85% and 75%, respectively. If the savings are in the ratio 8 : 9 : 20, then the income of the second family is:

- Ans
- 1. ₹32,000
  - 2. ₹16,000
  - 3. ₹40,000
  - 4. ₹24,000

Q.9  $\triangle XYZ$  is similar to  $\triangle PQR$ . If the ratio of the perimeter of  $\triangle XYZ$  to the perimeter of  $\triangle PQR$  is 16 : 9 and  $PQ = 3.6$  cm, then what is the length (in cm) of  $XY$ ?

- Ans
- 1.  $2\frac{3}{5}$
  - 2.  $4\frac{3}{5}$
  - 3.  $6\frac{2}{5}$
  - 4.  $3\frac{4}{5}$

Q.10 Two cubes have their volumes in the ratio 1 : 125. Find the ratio of their surface areas.

- Ans
- 1. 1 : 125
  - 2. 1 : 25
  - 3. 25 : 1
  - 4. 1 : 5

Q.11 A dishonest dealer professes to sell his goods at the cost price, but he uses a false weight of 850 grams per 1 kg weight. Find the percentage of his gain. (Correct up to two decimal places)

- Ans
- 1. 17.65%
  - 2. 17.45%
  - 3. 17.54%
  - 4. 17.56%

Q.12 What is the value of the following expression?

$$\left(24 \div 3 \text{ of } \frac{1}{6}\right) \times \left(\frac{4}{5} \div \frac{9}{8} \times \frac{3}{5}\right) \div \left(\frac{4}{7} \div \frac{3}{14} \text{ of } \frac{3}{14}\right)$$

- Ans
- 1.  $\frac{579}{459}$
  - 2.  $\frac{288}{175}$
  - 3.  $\frac{379}{179}$
  - 4.  $\frac{363}{553}$

Q.13

Study the given bar-graph and answer the question that follows.

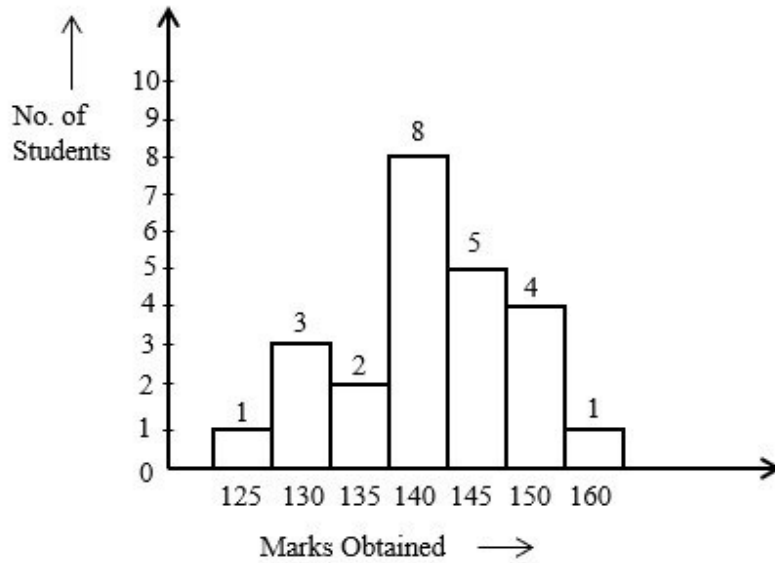

How many students obtained more than 135 marks?

Ans

1. 17  
 2. 19  
 3. 13  
 4. 18

Q.14 If Ramu's salary is 30% less than Somu's salary, then by how much percent is Somu's salary more than Ramu's salary?

Ans

1. 42.67%  
 2. 42.86%  
 3. 45.47%  
 4. 34.56%

Q.15 A shopkeeper allows a discount of 22% to his customers and still gains 36%. Find the marked price (in ₹) of an article which costs ₹1,092 to the shopkeeper.

Ans

1. 1,792  
 2. 2,024  
 3. 1,872  
 4. 1,904

Q.16 PQ and RS are two chords of a circle such that PQ = 12 cm and RS = 20 cm and PQ is parallel to RS. If the distance between PQ and RS is 4 cm, find the diameter of the circle.

Ans

1.  $2\sqrt{34}$  cm  
 2.  $3\sqrt{34}$  cm  
 3.  $6\sqrt{34}$  cm  
 4.  $4\sqrt{34}$  cm

Q.17

The following table shows the number of employees working in four organisations during six years. Answer the questions that follow.

Organization	Year					
	2010	2011	2012	2013	2014	2015
X	52	82	62	34	68	76
Y	105	80	120	160	95	100
Z	103	86	88	212	180	129
T	153	221	128	126	97	106

What is the average number of employees in organisations Y, Z and T in 2013?

Ans

- 1. 166
- 2. 168
- 3. 170
- 4. 172

Q.18

30 men working 5 hours a day can do work in 18 days. In how many days will 20 men working 7 hours a day do the same work?

Ans

- 1.  $11\frac{3}{7}$
- 2.  $16\frac{5}{7}$
- 3.  $19\frac{2}{7}$
- 4.  $13\frac{1}{7}$

Q.19

Study the given bar-graph and answer the question that follows.

The bar-graph represents the number of boys and girls in different sections of class 12.

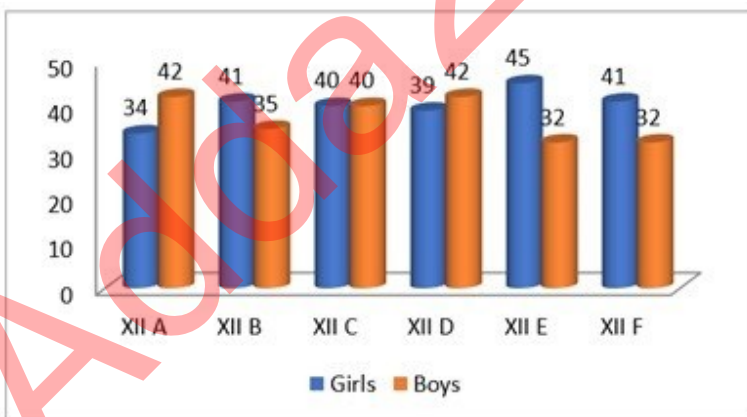

The average number of girls in each section is:

Ans

- 1. 42
- 2. 43
- 3. 37
- 4. 40

Q.20 The average salary of a group of 12 employees in an institution is ₹3,950 per month and that of another group of employees is ₹1,850. If the average salary of all employees is ₹2,150, then the total number of employees is:

- Ans
- 1. 100
  - 2. 88
  - 3. 84
  - 4. 72

Q.21 A part of the journey is covered in 22.5 minutes at a speed of 68 km/h and the remaining part in 12 minutes at a speed of 72 km/h. The total distance of the journey is (to the nearest integer):

- Ans
- 1. 40 km
  - 2. 38 km
  - 3. 42 km
  - 4. 35 km

Q.22 The pie chart below depicts the percentage distribution of the costs associated with publishing a book.

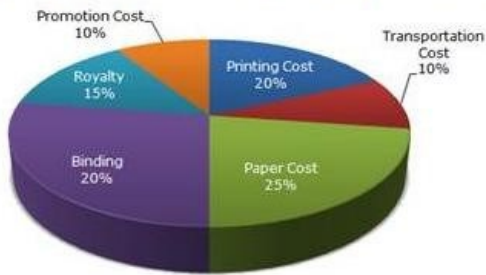

What will be the royalty rate for these books if the publisher is required to pay Rs.30,600 in printing costs for a specific number of volumes?

- Ans
- 1. Rs.21,200
  - 2. Rs.26,150
  - 3. Rs.19,450
  - 4. Rs.22,950

Q.23 PQ is the diameter of a circle with centre O. PT is a tangent touching the circle at P. The secant QT intersects the circle at S. O and S are joined. If  $\angle SOP = 104^\circ$ , what is the measure (in degrees) of  $\angle PTQ$ ?

- Ans
- 1. 45
  - 2. 62
  - 3. 76
  - 4. 38

Q.24 A number is first decreased by 18% and the resulting number is then increased by 25%. What is the overall percentage change in the original number?

- Ans
- 1. Decrease by 2.5%
  - 2. Increase by 3.5%
  - 3. Increase by 2.5%
  - 4. Decrease by 3.5%

Q.25 Consider AD is a tangent to a circle of radius 6 cm. AC is a secant meeting the circle at B and CD is a diameter. If AB is 7 cm, then the value of AC (in cm) is:

- Ans
- 1. 9
  - 2. 18
  - 3. 20
  - 4. 16

Q.1 In which year was the 15<sup>th</sup> National Census Survey of India conducted?

- Ans
- 1. 1991
  - 2. 2011
  - 3. 2021
  - 4. 2001

2. Which of the following is a cyclic arrangement of time units in Hindustani classical music?

- Ans
- 1. Tala
  - 2. Nyasa
  - 3. Jati
  - 4. Raga

3. The Bhotia dance form is a folk-dance from which of the following Indian states?

- Ans
- 1. Goa
  - 2. Tamil Nadu
  - 3. Odisha
  - 4. Uttarakhand

Q.4 What is the penalty for a wide ball in cricket?

- Ans
- 1. One run
  - 2. Six runs
  - 3. Four runs
  - 4. A free hit

Q.5 The point in the orbit of an object (such as a satellite) orbiting the earth that is at the greatest distance from the centre of the earth is known as:

- Ans
- 1. aphelion
  - 2. perigee
  - 3. apogee
  - 4. perihelion

Q.6 Who founded the Bombay Presidency Association in 1885 along with Pherozeshah Mehta and KT

- Telang? Ans
- 1. AK Fazlul Haq
  - 2. Zakir Husain
  - 3. Behramji M Malabari
  - 4. Badruddin Tyabji

Q.7 What is the keyboard shortcut for opening a blank new document in MS-Word?

- Ans
- 1. Ctrl + N
  - 2. Ctrl + S
  - 3. Ctrl + B
  - 4. Ctrl + C

Q.8 Which of the following is NOT a way to acquire citizenship in India?

- Ans
- 1. Renunciation
  - 2. Registration
  - 3. Birth
  - 4. Incorporation of territory



Q.9 Which of the following countries was the host of the ICC World Test Championship Cricket final played between India and New Zealand from 18-23 June 2021?

- Ans
- 1. South Africa
  - 2. Australia
  - 3. India
  - 4. England

Q.10 Which city will host 2028 Olympics games?

- Ans
- 1. New York, USA
  - 2. Los Angles, USA
  - 3. Boston, USA
  - 4. San Diego, USA

Q.11 BVR Subrahmanyam was appointed as the \_\_\_\_\_, in February 2023.

- Ans
- 1. CEO of NITI Aayog
  - 2. CEO of IBRD
  - 3. Chairman of UPSC
  - 4. Chairman of NITI Aayog

Q.12 Select the musical instrument which is NOT played by way of percussion or NOT played by way of striking any object?

- Ans
- 1. Shehnai
  - 2. Tabla
  - 3. Pakhawaj
  - 4. Drum

Q.13 With reference to the Directive Principles of State policy contained in the Constitution of India, which of the following statements is/are correct?

1. Article 37 of the Constitution of India provides that the Directive Principles of State Policy are enforceable in the High Courts only.
2. Article 38 provides that the State shall strive to minimise the inequalities in income amongst individuals and groups of people.
3. Article 39 provides that the State shall direct its policy towards securing that there is equal pay for equal work for both men and women.

- Ans
- 1. Only 1 and 3
  - 2. Only 2
  - 3. Only 1
  - 4. Only 2 and 3

Q.14 The Mundra Thermal Power Plant is located in which district of Gujarat?

- Ans
- 1. Gandhinagar
  - 2. Kheda
  - 3. Kutch
  - 4. Jamnagar

Q.15 How many languages are included in the Eighth Schedule of the Constitution of India as scheduled languages?

- Ans
- 1. 23
  - 2. 21
  - 3. 22
  - 4. 24

Q.16 Match the items in List I with those in List II.

**List I**

**List II**

i. Garibi Hatao

a. Fifth Five-Year Plan

ii. LPG policies

b. Ninth Five-Year Plan

iii. Rolling Plan

c. 1978-80

iv. Growth with justice and equity

d. Eighth Five-Year Plan

- Ans
- 1. i-a, ii-d, iii-c, iv-b
  - 2. i-c, ii-b, iii-d, iv-a
  - 3. i-c, ii-d, iii-a, iv-b
  - 4. i-b, ii-c, iii-d, iv-a

Q.17 Which keyboard key is used to jump the cursor to the next cell of the table in MS Word?

- Ans
- 1. Shift
  - 2. Tab
  - 3. Home
  - 4. Ctrl

Q.18 Which of the following is NOT a mutation-based disease?

- Ans
- 1. Sickle cell anaemia
  - 2. Malaria
  - 3. Phenylketonuria
  - 4. Down syndrome

Q.19 In March 2023, Rashmi Shukla was appointed as the Director General of which organisation?

- Ans
- 1. Border Security Force
  - 2. Central Reserve Police Force
  - 3. Sashastra Seema Bal
  - 4. Indo-Tibetan Border Police

Q.20 Which of the following statements is/are correct  
I.- Maximum National Parks in India are located in the state of Madhya Pradesh.  
II.- Mudumalai National Park is located in Kerala.  
III.- The Salim Ali Centre for Ornithology and Natural History is located in Tamil Nadu.

- Ans
- 1. Both I and II are correct
  - 2. Only I is correct.
  - 3. Both I and III are correct
  - 4. Only III is correct

Q.21 Easter is a religious festival of:

- Ans
- 1. Christians
  - 2. Hindus
  - 3. Buddhists
  - 4. Sikhs

Q.22 India's first indigenous Aircraft Carrier, \_\_\_\_\_, conducted its maiden sea travel in August 2021 marking a significant step towards making military equipment in India.

- Ans
- 1. INS Vikrant
  - 2. INS Swades
  - 3. INS Kranti
  - 4. INS Vayudooth

Q.23 Who was the founder of the Bahmani Sultanate?

- Ans
- 1. Alauddin Hasan Bahman Shah
  - 2. Muhammad Shah
  - 3. Feroz Shah Bahmani
  - 4. Muhammad Bin Tughlaq

Q.24 Rotating Savings and Credit Association (ROSCA) was introduced by Shirley Ardener in the year \_\_\_\_\_.

- Ans
- 1. 1970
  - 2. 1964
  - 3. 1963
  - 4. 1955

Q.25 If an object of mass 2 kg is dropped from a height of 10 metres, what will be the ratio of its potential energy and kinetic energy at the height of 5 metres ( $g=10\text{m/sec}^2$ )

- Ans
- 1. 1:1
  - 2. 4:1
  - 3. 1:4
  - 4. 1:2

## Combined Higher Secondary Level Examination 2024 Tier I

Exam Date	09/07/2024
Exam Time	2:30 PM - 3:30 PM
Subject	CHSL Exam 2024 Tier I

### Section : English Language

1. The following sentence has been split into four segments. Identify the segment that contains a grammatical error. The workers called out / the strike because / the management acceded to / all their demands.

- Ans
- 1. the strike because
  - 2. all their demands
  - 3. the management acceded to
  - 4. The workers called out

2. The following sentence has been divided into four segments. Identify the segment that contains a grammatical error. She / did not watched / Frankenstein / last night.

- Ans
- 1. did not watched
  - 2. Frankenstein
  - 3. She
  - 4. last night.

3. The given sentence is divided into four segments. Identify the segment that contains a grammatical error. A company can / make money by / obtain resources / more affordably.

- Ans
- 1. A company can
  - 2. make money by
  - 3. obtain resources
  - 4. more affordably.

Q.4 Select the most appropriate option that can substitute the underlined segment in the given sentence. Mahima is as smarter as Shilpi.

- Ans
- 1. as smart as
  - 2. more smart as
  - 3. most smart as
  - 4. smartest than

**Comprehension:**

In the following passage, some words have been deleted. Read the passage carefully and select the most appropriate option to fill in each blank.

Conversation is indeed the (1)\_\_\_\_\_teachable of all arts. All you need to do in order to become a good conversationalist is to find a (2)\_\_\_\_\_that interests you and your listeners. But the important thing is that you must talk about the other (3)\_\_\_\_\_hobby rather than your own. Therein lies the secret of your (4)\_\_\_\_\_. Talk to your friends about the things that interest them, and you will get a reputation for good fellowship, charming wit, and a brilliant mind. There is nothing that (5)\_\_\_\_\_people so much as your interest in their interest.

**SubQuestion No : 5****Q.5 Select the most appropriate option to fill in blank number 1.**

- Ans**
- 1. more easily
  - 2. more likely
  - 3. most easily
  - 4. most occasionally

**Comprehension:**

In the following passage, some words have been deleted. Read the passage carefully and select the most appropriate option to fill in each blank.

Conversation is indeed the (1)\_\_\_\_\_teachable of all arts. All you need to do in order to become a good conversationalist is to find a (2)\_\_\_\_\_that interests you and your listeners. But the important thing is that you must talk about the other (3)\_\_\_\_\_hobby rather than your own. Therein lies the secret of your (4)\_\_\_\_\_. Talk to your friends about the things that interest them, and you will get a reputation for good fellowship, charming wit, and a brilliant mind. There is nothing that (5)\_\_\_\_\_people so much as your interest in their interest.

**SubQuestion No : 6****Q.6 Select the most appropriate option to fill in blank number 2.**

- Ans**
- 1. credit
  - 2. subject
  - 3. luxury
  - 4. result

**Comprehension:**

In the following passage, some words have been deleted. Read the passage carefully and select the most appropriate option to fill in each blank.

Conversation is indeed the (1)\_\_\_\_\_teachable of all arts. All you need to do in order to become a good conversationalist is to find a (2)\_\_\_\_\_that interests you and your listeners. But the important thing is that you must talk about the other (3)\_\_\_\_\_hobby rather than your own. Therein lies the secret of your (4)\_\_\_\_\_. Talk to your friends about the things that interest them, and you will get a reputation for good fellowship, charming wit, and a brilliant mind. There is nothing that (5)\_\_\_\_\_people so much as your interest in their interest.

**SubQuestion No : 7****Q.7 Select the most appropriate option to fill in blank number 3.**

- Ans**
- 1. worker's
  - 2. self's
  - 3. victim's
  - 4. fellow's

**Comprehension:**

In the following passage, some words have been deleted. Read the passage carefully and select the most appropriate option to fill in each blank.

Conversation is indeed the (1)\_\_\_\_\_teachable of all arts. All you need to do in order to become a good conversationalist is to find a (2)\_\_\_\_\_that interests you and your listeners. But the important thing is that you must talk about the other (3)\_\_\_\_\_hobby rather than your own. Therein lies the secret of your (4)\_\_\_\_\_. Talk to your friends about the things that interest them, and you will get a reputation for good fellowship, charming wit, and a brilliant mind. There is nothing that (5)\_\_\_\_\_people so much as your interest in their interest.

**SubQuestion No : 8****Q.8 Select the most appropriate option to fill in blank number 4.**

- Ans**
- 1. popularity
  - 2. audacity
  - 3. irrationality
  - 4. capacity

**Comprehension:**

In the following passage, some words have been deleted. Read the passage carefully and select the most appropriate option to fill in each blank.

Conversation is indeed the (1)\_\_\_\_\_teachable of all arts. All you need to do in order to become a good conversationalist is to find a (2)\_\_\_\_\_that interests you and your listeners. But the important thing is that you must talk about the other (3)\_\_\_\_\_hobby rather than your own. Therein lies the secret of your (4)\_\_\_\_\_. Talk to your friends about the things that interest them, and you will get a reputation for good fellowship, charming wit, and a brilliant mind. There is nothing that (5)\_\_\_\_\_people so much as your interest in their interest.

**SubQuestion No : 9**

**Q.9** Select the most appropriate option to fill in blank number 5.

- Ans
- 1. accompanies
  - 2. admits
  - 3. pleases
  - 4. advances

**Q.10** Select the most appropriate synonym of the underlined word.  
The girl tried to alleviate her brother's problem.

- Ans
- 1. increase
  - 2. soar
  - 3. reduce
  - 4. worsen

**Q.11** Select the most appropriate ANTONYM of the underlined word.

The encounter made the audience squirm.

- Ans
- 1. Speak
  - 2. Relax
  - 3. Chat
  - 4. Pray

**Q.12** Select the most appropriate option that can substitute the underlined segment in the given sentence. If there is no need to substitute it, select 'No substitution required'.  
The small size of his store makes it impossible for him to stock all the items.

- Ans
- 1. made them impossible
  - 2. making it impossible
  - 3. is made it impossible
  - 4. No substitution required

**Q.13** Select the most appropriate option to fill in the blank.

I would like to reach the \_\_\_\_\_ of the Everest.

- Ans
- 1. peek
  - 2. pick
  - 3. pike
  - 4. peak

**Q.14** Select the most appropriate synonym of the underlined word.

John is very generous; he regularly gives alms to the poor.

- Ans
- 1. popular
  - 2. great
  - 3. kind
  - 4. shrewd

Q.15 Select the most appropriate option that can substitute the underlined segment in the given sentence.  
Bill Gates' fortune was bequeathed for the old age home.

- Ans
- 1. into the old age home
  - 2. to the old age home
  - 3. by the old age home
  - 4. with the old age home

Q.16 Select the most appropriate ANTONYM of the underlined word in the given sentence.  
The coach was optimistic that Ronald will play the quarter final.

- Ans
- 1. Tasteful
  - 2. Cheerful
  - 3. Doubtful
  - 4. Helpful

Q.17 Select the most appropriate option to correct the sentence by using the proper meaning of the underlined word.  
He scores good marks in exams as he is quite meticulous.

- Ans
- 1. Selective
  - 2. Careful
  - 3. Intelligent
  - 4. Lazy

Q.18 Choose an appropriate word that can substitute the bracketed word and complete the sentence meaningfully.  
He never (talks) the truth.

- Ans
- 1. speaks
  - 2. declares
  - 3. narrates
  - 4. utters

Q.19 Select the most appropriate option that can substitute the underlined segment in the given sentence.

Professor Singh is not in the office today. I ask you try call him tomorrow.

- Ans
- 1. suggest you try calling
  - 2. am suggesting you calling
  - 3. ask you to try called
  - 4. asked you to call

Q.20 The given sentence is divided into four segments. Identify the segment that contains a spelling error. When the famous businessman / faced a huge loss / in his business, / no one expressed sympathy.

- Ans
- 1. in his business
  - 2. When the famous businessman
  - 3. no one expressed sympathy
  - 4. faced a huge loss

Q.21 Select the most appropriate meaning of the given idiom.

A wild goose chase

- Ans
- 1. Ideal seeking
  - 2. Fruitless search
  - 3. Fruitful search
  - 4. On a hunt

Q.22 Select the INCORRECTLY spelt word in the given sentence.  
The ministir ordered the engineers to build roads through high mountains and bridges across deep ravines in a week.

- Ans
- 1. Ravines
  - 2. Engineers
  - 3. Ministir
  - 4. Bridges

Q.23 Select the most appropriate synonym of the bracketed word in the following sentence to fill in the blank.  
The meeting was brought to a \_\_\_\_\_ (rapid) conclusion.

- Ans
- 1. stubborn
  - 2. pervious
  - 3. grim
  - 4. hasty

Q.24 Select the most appropriate meaning of the given idiom.  
An old head on young shoulders

- Ans
- 1. A young person who looks old.
  - 2. A young person who is lazy.
  - 3. A person who is slow at understanding things.
  - 4. A young person who acts or speaks like an older person.

Q.25 Select the most appropriate ANTONYM of the underlined word.

The poet was lost in a reverie.

- Ans
- 1. Reality
  - 2. Fantasy
  - 3. Daydream
  - 4. Trance

Section : General Intelligence

1. Four letter-clusters have been given, out of which three are alike in some manner and one is different. Select the letter-cluster that is different.

(Note: The odd one out is not based on the number of consonants/vowels or their position in the letter cluster.)

- Ans
- 1. DEVV
  - 2. QRJI
  - 3. OPMK
  - 4. JKQP



Q.2 What would be the word on the opposite side of 'Green' if the given sheet is folded to form a cube?

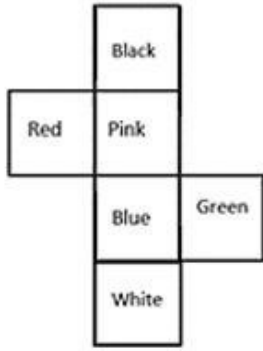

- Ans
- ✓ 1. Red
  - ✗ 2. Black
  - ✗ 3. Pink
  - ✗ 4. White

Q.3 Identify the figure given in the options which when put in place of ? will logically complete the series.

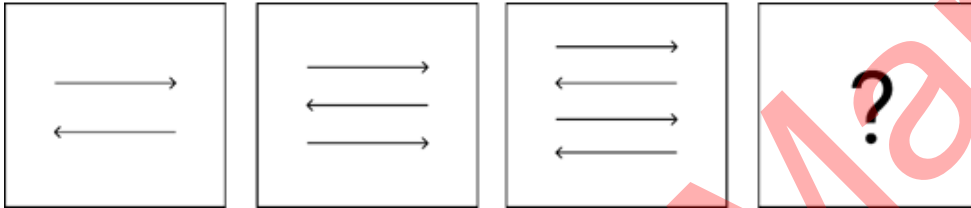

- Ans
- ✗ 1.
  - ✓ 2.
  - ✗ 3.
  - ✗ 4.

Q.4 If 22 March 2000 is a Wednesday, then what will the day of the week on 16th January 2010?

- Ans
- 1. Wednesday
  - 2. Tuesday
  - 3. Sunday
  - 4. Saturday

Q.5 Select the set in which the numbers are related in the same way as are the numbers of the following sets.  
(NOTE: Operations should be performed on the whole numbers, without breaking down the numbers into its constituent digits. E.g. 13 – Operations on 13 such as adding/subtracting/multiplying etc. to 13 can be performed. Breaking down 13 into 1 and 3 and then performing mathematical operations on 1 and 3 is not allowed.)  
(120, 8, 15)  
(144, 24, 6)

- Ans
- 1. (134, 22, 6)
  - 2. (115, 23, 5)
  - 3. (106, 4, 26)
  - 4. (124, 6, 21)

Q.6 What should come in place of '?' in the given series?

126 1236 12336 123336 1233336 ?

- Ans
- 1. 12333336
  - 2. 12333366
  - 3. 1233633
  - 4. 12333363

Q.7 Which two numbers should be interchanged to make the given equation correct?

$$29 + 46 - (48 \div 4) + (7 \times 3) - 26 = 61$$

(NOTE: Numbers must be interchanged and not the constituent digits e.g. if 2 and 3 are to be interchanged in the equation  $43 \times 3 + 4 \div 2$ , then interchanged equation is  $43 \times 2 + 4 \div 3$ )

- Ans
- 1. 46 and 26
  - 2. 46 and 48
  - 3. 26 and 29
  - 4. 4 and 3

Q.8 This question consists of a pair of words which have a certain relationship to each other. Select the pair which does NOT have the same relationship.

Smart : Intelligent  
1) Liable : Accountable  
2) Modest : Humble  
3) Nimble : Sluggish  
4) Outbreak : Eruption

- Ans
- 1. 1
  - 2. 2
  - 3. 4
  - 4. 3

Q.9 Read the given statements and conclusions carefully. Assuming that the information given in the statements is true, even if it appears to be at variance with commonly known facts, decide which of the given conclusions logically follow(s) from the statements.

Statements:

No cloud is a mountain.

All mountains are rivers.

All rivers are oceans.

Conclusions:

(I) All rivers can never be clouds.

(II) All mountains are oceans.

- Ans
- 1. None of the conclusions follow
  - 2. Only conclusion I follows
  - 3. Only conclusion II follows
  - 4. Both conclusions I and II follow

Q.10 If 19 February 2014 was Wednesday, then what was the day of the week on 19 February 2022?

- Ans
- 1. Thursday
  - 2. Tuesday
  - 3. Wednesday
  - 4. Saturday

Q.11 How many triangles are there in the following figure?

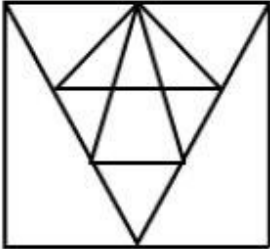

- Ans
- 1. 21
  - 2. 20
  - 3. 19
  - 4. 18

Q.12 What should come in place of the question mark (?) in the given series based on the English alphabetical order?

AEO, XAM, UWK, RSI, ?

- Ans
- 1. NMF
  - 2. LMH
  - 3. OOG
  - 4. MNH

Q.13 In a certain code language,

'A@ B' means 'A is the husband of B',

'A # B' means 'A is the mother of B',

'A & B' means 'A is the daughter of B',

'A \$ B' means 'A is the brother of B'.

Based on this, how is P related to M, if 'M & N @ O # P \$ Q'?

- Ans
- 1. Brother
  - 2. Son
  - 3. Father
  - 4. Father's brother

Q.14 What will come in the place of '?' in the following equation if '+' and '÷' are interchanged and '×' and '-' are interchanged?  
 $36 - 42 \div 26 + 13 \times 14 = ?$

- Ans
- 1. 3467
  - 2. 1324
  - 3. 1200
  - 4. 1500

Q.15 EHJL is related to FJMP in a certain way based on the English alphabetical order. In the same way, BEGI is related to CGJM. To which of the following is DGIK related, following the same logic?

- Ans
- 1. EIJO
  - 2. EILO
  - 3. ELIO
  - 4. EJIO

Q.16 In a certain code language, 'if you are' is coded as 'go so lu' and 'where are you' is coded as 'so lu ga'. What is the code for 'where' in that language?

- Ans
- 1. lu
  - 2. ga
  - 3. so
  - 4. go

Q.17 242 is related to 22 following a certain logic. Following the same logic, 385 is related to 35. To which of the following is 572 related following the same logic?  
(NOTE : Operations should be performed on the whole numbers, without breaking down the numbers into its constituent digits. E.g. 13 – Operations on 13 such as adding /deleting /multiplying etc., to 13 can be performed. Breaking down 13 into 1 and 3 and then performing mathematical operations on 1 and 3 is not allowed.)

- Ans
- 1. 56
  - 2. 54
  - 3. 50
  - 4. 52

Q.18 Select the option in which the given figure is embedded. (Rotation is NOT allowed).

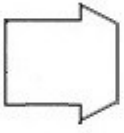

Ans

✗ 1.

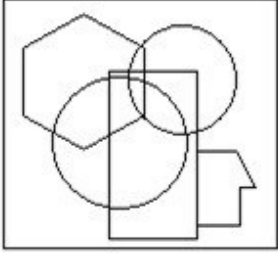

✓ 2.

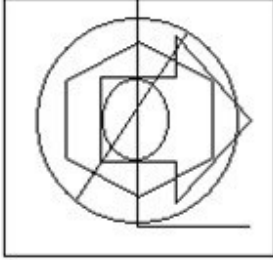

✗ 3.

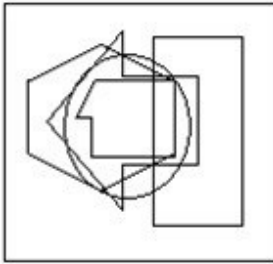

✗ 4.

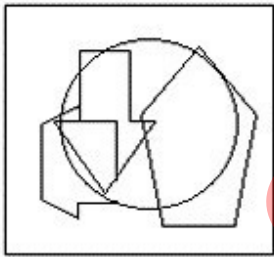

Adda247 Marathi

Q.19 Select the option in which the given figure is embedded. (Rotation is NOT allowed.)

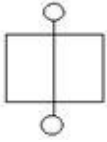

Ans

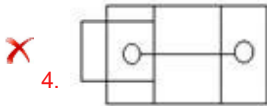
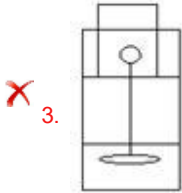
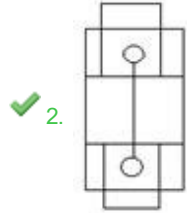
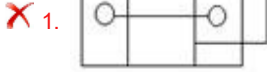

Q.20 Which of the following numbers will replace the question mark (?) in the given series?  
86 129 105 118 124 107 143 96 ?

Ans

✗ 1. 149

✗ 2. 138

✓ 3. 162

✗ 4. 153

Q.21 Select the term from among the given options that can replace the question mark (?) in the following series based on the English alphabetical order.

JKL, LHP, NET, ?, RYB, TVF

Ans

✗ 1. RAL

✓ 2. PBX

✗ 3. POF

✗ 4. COL

Q.22 In a certain code language, 'future is bright' is coded as 'pl mk ni' and 'bright shooting star' is coded as 'dg rz pl'. How is 'bright' coded in that language?

Ans

✗ 1. dg

✓ 2. pl

✗ 3. mk

✗ 4. ni

Q.23 A paper is folded and cut as shown below. How will it appear when unfolded?

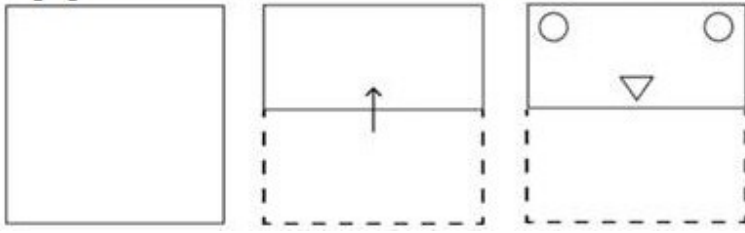

Ans

✓ 1.

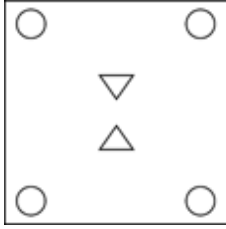

✗ 2.

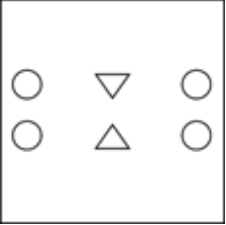

✗ 3.

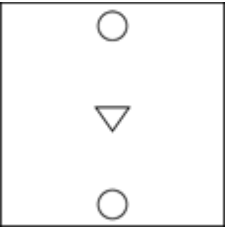

✗ 4.

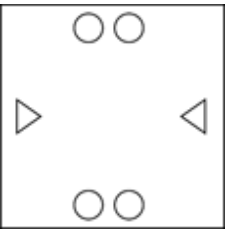

Adda247 Marathi

Q.24 Select the correct mirror image of the given figure when the mirror is placed at MN.

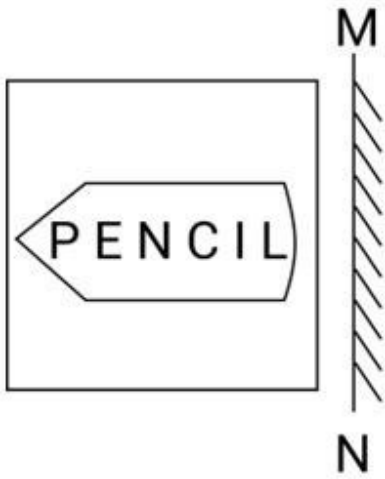

Ans

X 1.



X 2.

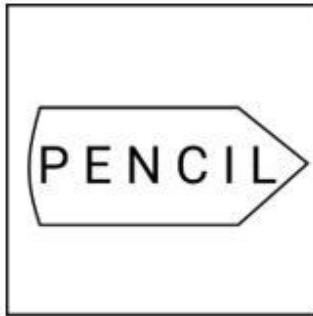

✓ 3.

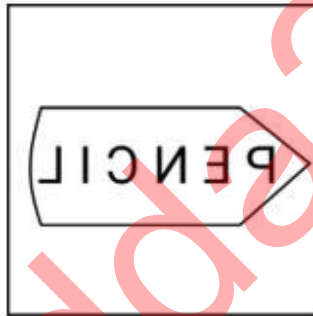

X 4.





Q.25 If 'A' stands for '+', 'B' stands for '×', 'C' stands for '÷' and 'D' stands for '−', what will come in place of the question mark (?) in the following equation?

$$222 \text{ A } 2 \text{ C } 7 \text{ B } 3 \text{ D } 11 = ?$$

- Ans
- 1. 141
  - 2. 131
  - 3. 121
  - 4. 111

Section : Quantitative Aptitude

Q.1 Study the following bar chart, which represents the income and expenditure of a company.

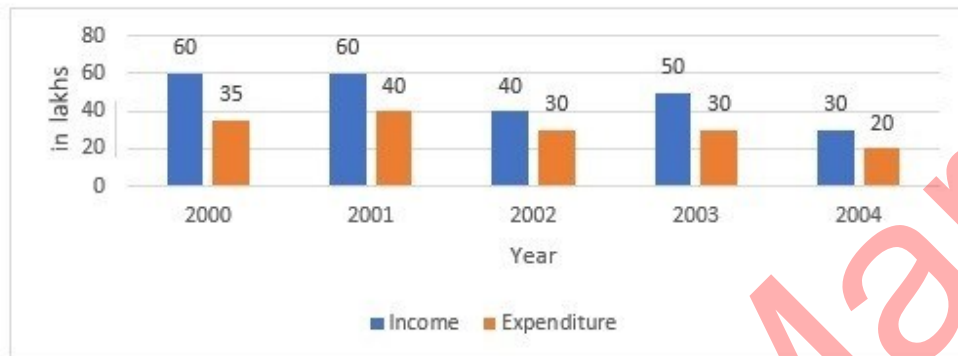

In how many years is the income of company less than the average income?

- Ans
- 1. 5
  - 2. 4
  - 3. 2
  - 4. 3

Q.2 Ramesh sells an article for ₹34,440, after allowing an 18% discount on the marked price and still manages to gain 40% profit. If Ramesh sold the article at a 12% discount on the marked price, then what will be his profit, correct to two places of decimals?

- Ans
- 1. 50.42%
  - 2. 48.24%
  - 3. 50.24%
  - 4. 48.42%

Q.3 A tangent is drawn from a point that is at a distance of 37 cm from center of the circle O, and diameter is 24 cm. The length (in cm) of the tangent is:

- Ans
- 1. 30
  - 2. 35
  - 3. 28.16
  - 4. 37

Q.4

If  $\sin\theta = \frac{7}{25}$ , then

$\cos\theta$  and  $\tan\theta$  are respectively \_\_\_\_\_.

(where  $\theta$  is in the first quadrant)

Ans

1.  $\frac{25}{24}$  and  $\frac{24}{7}$

2.  $\frac{25}{7}$  and  $\frac{7}{24}$

3.  $\frac{24}{25}$  and  $\frac{24}{7}$

4.  $\frac{24}{25}$  and  $\frac{7}{24}$

Q.5

The average marks scored by the students of a class is 75. If the average marks scored by the girls in the same class is 90 and that of boys is 70, what is the percentage of boys in the class?

Ans

1. 60%

2. 65%

3. 70%

4. 75%

Q.6

By selling 60 pens, a man gains an amount equal to the selling price of 12 pens. What is his gain percentage?

Ans

1. 20%

2. 22%

3. 25%

4. 27%

Q.7

The lines  $x+y = 10$  and  $-3x+y = 2$  have a unique solution. What is the distance (in units) between the unique solution and the point of intersection of the line  $x+y = 10$  and the x-axis?

Ans

1.  $8\sqrt{2}$

2. 8

3. 10

4.  $10\sqrt{2}$

Q.8

Evaluate the given expression.

$$(45 + 9) \div 2 - 7 \times 33 \div 7 + \{(7 + 18) \times 6\} + 9 \times 8 - 89$$

Ans

1. 112

2. 118

3. 125

4. 127

Q.9 An amount invested fetched a total simple interest of ₹4,050 at the rate of 9% per annum in 5 years. What is the amount invested (in ₹)?

- Ans
- 1. 9,000
  - 2. 8,300
  - 3. 7,500
  - 4. 9,050

Q.10 If 6 engineers can complete a work in 5 days and 5 skilled workers can complete the same work in 7 days, then the time taken (in days) to complete the same work by 7 engineers and 4 skilled workers will be:

- Ans
- 1.  $2\frac{64}{70}$
  - 2.  $3\frac{64}{73}$
  - 3.  $2\frac{64}{73}$
  - 4.  $2\frac{65}{73}$

Q.11 The given bar graph shows the percentage of production of three companies C1, C2 and C3 over five years. Study the bar graph and answer the question that follows.



If the ratio of the total production in the year 2019 and 2022 is 3:5 and the total production in C1 in 2022 is 4125, then the total production of C3 in the year 2019 is:

- Ans
- 1. 5175
  - 2. 9000
  - 3. 2250
  - 4. 1575

Q.12 If Tanya walks at the speed of 6 km/h, she misses a train by 2 minutes. However, if she walks at the speed of 8 km/h, she reaches the station 3 minutes before the arrival of the train. The distance covered by Tanya to reach the station is:

- Ans
- 1. 3 km
  - 2. 2.5 km
  - 3. 2.75 km
  - 4. 2 km

Q.13 Find the equation of the sphere having centre (-1,2,-3) and the radius of 3 units.

- Ans
- 1.  $x^2 + y^2 + z^2 - 2x + 4y - 6z + 5 = 0$
  - 2.  $x^2 + y^2 + z^2 + x - 2y + 3z + 5 = 0$
  - 3.  $x^2 + y^2 + z^2 + 2x - 4y + 6z + 5 = 0$
  - 4.  $x^2 + y^2 + z^2 - x + 2y - 3z + 5 = 0$

Q.14 A tangent is drawn from a point at a distance of 25cm from the Centre of a circle  $C(0, r)$  of radius 7cm. The length of the tangent is \_\_\_\_\_ cm.

- Ans
- 1. 24
  - 2. 20
  - 3. 8
  - 4. 16

Q.15 If a person's salary increases from ₹200 per day to ₹234 per day, then the percentage increase in the person's salary is:

- Ans
- 1. 17%
  - 2. 14%
  - 3. 15%
  - 4. 16%

Q.16 Read the given information and answer the question that follows.

The following table gives the percentage of marks obtained by seven students in six different subjects in an examination.

The number in the brackets gives the maximum marks in each subject.

Student	Subject (Max. Marks)					
	Maths	Chemistry	Physics	Geography	History	Computer Science
	(150)	(130)	(120)	(100)	(60)	(40)
Ayush	90	50	90	60	70	80
Aman	100	80	80	40	80	70
Sajal	90	60	70	70	90	70
Rohit	80	65	80	80	60	60
Muskan	80	65	85	95	50	90
Tanvi	70	75	65	85	40	60
Tarun	65	35	50	77	80	80

What is the median raw score of the marks obtained by the seven students in Chemistry?

- Ans
- 1. 65
  - 2. 81.25
  - 3. 84.5
  - 4. 62.5

Q.17 The value of  $\frac{5+7 \times 5 \div 8 \text{ of } 5+3 \div 3 \times 5}{6 \div 6 \text{ of } 4+9 \times 9 \div 3 \times 2 \times 2}$  is:

Ans

1.  $\frac{77}{861}$

2.  $\frac{97}{881}$

3.  $\frac{67}{859}$

4.  $\frac{87}{866}$

Q.18 A car is sold for ₹5,00,000, which is 20% less than its original price. What was the original price of the car?

Ans

1. ₹6,25,000

2. ₹6,50,000

3. ₹6,75,000

4. ₹6,00,000

Q.19 The area of three adjacent faces of a cuboidal box is  $120 \text{ cm}^2$ ,  $72 \text{ cm}^2$  and  $60 \text{ cm}^2$ , respectively. Find the volume (in  $\text{cm}^3$ ) of the box.

Ans

1. 425

2. 650

3. 720

4. 864

Q.20 If the radius of the base and slant height of the cone is 6 cm and 10 cm, respectively, then the volume of the cone is equal to:

Ans

1.  $98 \pi \text{ cm}^3$

2.  $106 \pi \text{ cm}^3$

3.  $96 \pi \text{ cm}^3$

4.  $108 \pi \text{ cm}^3$

Q.21 If  $A : B = 5 : 8$  and  $B : C = 7 : 8$ , then find  $A : C$ .

Ans

1. 35 : 64

2. 55 : 30

3. 34 : 64

4. 35 : 56

Q.22 In an election there were only two candidates. One of the candidates secured 35% of votes and is defeated by the other candidate by 381 votes. The total number of votes polled is:

Ans

1. 635

2. 1028

3. 1270

4. 514

Q.23 In a right angle triangle with sides 12 cm and 16 cm and hypotenuse 20 cm, the length of altitude drawn on the hypotenuse from the opposite vertex is K. Find the value of K.

- Ans
- 1. 6.9 cm
  - 2. 9.6 cm
  - 3. 6.8 cm
  - 4. 8.6cm

Q.24

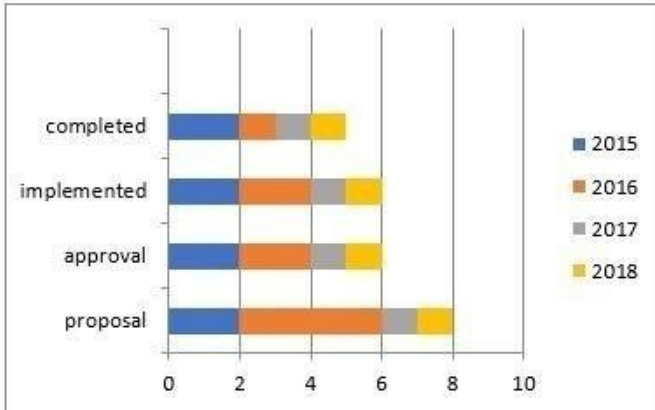

A company starts constructing buildings for a college. The constructions have 4 stages.

1. buildings proposals
2. proposals approval
3. constructions implemented
4. buildings completed

The above 3D-bar graph indicates the status of constructions for 4 years 2015 to 2018.

The X-axis scale 0, 2, 4, 6, 8, 10 indicates 0, 20%, 40%, 60%, 80%, 100%.

Study the bar graph carefully and answer the following questions.

Find the ratio of proposals to buildings completed for the year 2016.

- Ans
- 1. 2 : 3
  - 2. 2 : 1
  - 3. 3 : 1
  - 4. 4 : 1

Q.25 The sides ST and TR and the median SU of the  $\Delta STR$  are equal to the sides MN and NJ and the median MV of the  $\Delta MNJ$ , respectively. If  $\angle TSU = 46^\circ$ ,  $\angle NMJ = 79^\circ$  and  $\angle MVN = 88^\circ$ , what is the degree measure of  $\frac{7}{11} \angle SRT$ ?

- Ans
- 1.  $35^\circ$
  - 2.  $55^\circ$
  - 3.  $56^\circ$
  - 4.  $47^\circ$

Section : General Awareness

1. Which of the following is a food-borne disease caused by the consumption of contaminated food or beverages?

- Ans
- 1. Malaria
  - 2. Tuberculosis
  - 3. Chicken pox
  - 4. Cholera

2. Which key can be pressed to initiate a slide show in MS PowerPoint?

- Ans
- 1. Function key F4
  - 2. Function key F2
  - 3. Function key F8
  - 4. Function key F5

3. Which of the following Fundamental Rights has been deleted from the original list of fundamental rights provided in the Constitution of India?

- Ans
- 1. Right to freedom of religion
  - 2. Cultural and educational rights
  - 3. Right to constitutional remedies
  - 4. Right to property

Q.4 The approach driven by seven engines, which is powered by Clean Energy and 'Sabka Prayas' is related to which scheme?

- Ans
- 1. Aatmanirbhar Bharat Rojgar Yojana
  - 2. Pradhan Mantri Mudra Yojana
  - 3. Garib Kalyan Rojgar Abhiyan
  - 4. PM Gati Shakti Master Plan

Q.5 Bilhan was a court poet in which of the following kingdoms?

- Ans
- 1. Vikramaditya VI
  - 2. Rajaraja II
  - 3. Vijayaditya VII
  - 4. Kulottunga I

Q.6 Manipur's \_\_\_\_\_ tribe celebrates the 'Gaan-Ngai' festival, which is a post-harvest festival of the tribe living in the regions of Manipur.

- Ans
- 1. Zeliangrong
  - 2. Chothe
  - 3. Gangte
  - 4. Inpui

Q.7 Who among the following confirmed Maxwell's theories with the discovery of radio waves and also became the first person to transmit and receive controlled radio waves in 1886?

- Ans
- 1. Guglielmo Marconi
  - 2. William Hopkins
  - 3. Michael Faraday
  - 4. Heinrich Hertz

Q.8 Who was the first Indian wrestler to win a world championship medal?

- Ans
- 1. Udey Chand
  - 2. Dara Singh
  - 3. Malwa Singh
  - 4. KD Jadhav

Q.9 Calculate personal income (in ₹ crore) from the given data.

Particulars	₹ (in crore)
Private income	1800
Net retained earnings of private enterprises	500
Corporation tax	250

- Ans
- 1. 950
  - 2. 1100
  - 3. 2050
  - 4. 1000

Q.10 Match the pair correctly:

**National Waterways**

- a) NW-1
- b) Nw-2
- c) NW-3
- d) NW-5

**Stretch**

- 1. Kakinada-Puducherry
- 2. Kottapuram- Kallam
- 3. Allahabad - Haldia
- 4. Sadiya- Dhubri
- 5. Talchar-Dhamra

- Ans
- 1. a-3, b-4, c-2, d-5
  - 2. a-1, b-2, c-4, d-5
  - 3. a-4, b-3, c-5, d- 1
  - 4. a-2, b-5, c-3, d-1

Q.11 The Wild Life (Protection) Amendment Act, 2022 received the assent of the President on \_\_\_\_\_.

- Ans
- 1. 19 December 2022
  - 2. 14 December 2022
  - 3. 17 December 2022
  - 4. 10 December 2022

Q.12 Which Excel feature allows you to simultaneously edit the same cell or range of cells with multiple users in real-time?

- Ans
- 1. co-authoring
  - 2. Data Validation
  - 3. Conditional Formatting
  - 4. Track Changes

Q.13 Which statement about Syama Sastri is correct?

- Ans
- 1. His signature name was Guruguha.
  - 2. His famous composition is Pancharatna Kritis.
  - 3. He is one among the trinity of Carnatic Music.
  - 4. A crater on planet mercury is named after him.



**Q.14 Article 15 of the Constitution of India entails:**

- Ans**
- 1. cultural and educational rights
  - 2. equality of opportunity for all citizens in matters relating to employment or appointment
  - 3. freedom of speech and expression
  - 4. prohibition of discrimination against any citizen on grounds only of religion, race, caste, sex or place of birth

**Q.15 What was the name of the campaign led by the Ali brothers and Maulana Abul Kalam Azad to save the Ottoman Caliphate as a symbol of unity among the Muslim community?**

- Ans**
- 1. Wahabi Movement
  - 2. Khilafat Movement
  - 3. Ahmadiya Movement
  - 4. Faraizi Movement

**Q.16 Which of the following food grains highly benefited from the Green Revolution?**

- Ans**
- 1. Millet
  - 2. Barley
  - 3. Maize
  - 4. Wheat

**Q.17 What is 'Padam' in Carnatic Music?**

- Ans**
- 1. A patriotic poem
  - 2. A poem about courage
  - 3. A love poem
  - 4. A lullaby

**Q.18 Which of the following airports is being built as India's first 'carbon-neutral airport'?**

- Ans**
- 1. Jammu airport
  - 2. Kangra airport
  - 3. Srinagar airport
  - 4. Leh airport

**Q.19 In which country do Kachin, Karen, Karenni, Chin and Mon ethnic groups belong?**

- Ans**
- 1. Myanmar
  - 2. Afghanistan
  - 3. Sri Lanka
  - 4. Nepal

**Q.20 In the year 2021, which of the following ministries published the amended rules related to Corporate Social Responsibility (CSR)?**

- Ans**
- 1. Ministry of Science and Technology
  - 2. Ministry of Corporate Affairs
  - 3. Ministry of New and Renewable Energy
  - 4. Ministry of Home Affairs

**Q.21 A flat ring of small, icy bodies that revolve around the sun beyond the orbit of the planet Neptune is called:**

- Ans**
- 1. Asteroid Belt
  - 2. Bow Shock
  - 3. Kuiper Belt
  - 4. Oort Cloud

Q.22 In Cricket, the bowler does NOT get credit for \_\_\_\_\_.

- Ans
- 1. bowled
  - 2. LBW
  - 3. run out
  - 4. catch

Q.23 The Chilika Lake is located to the south of the \_\_\_\_\_ delta.

- Ans
- 1. Narmada
  - 2. Cauvery
  - 3. Mahanadi
  - 4. Godavari

Q.24 Mohiniyattam is a classical dance form of:

- Ans
- 1. Tripura
  - 2. Kerala
  - 3. Assam
  - 4. Tamil Nadu

Q.25 In which year was the Board of Control for Cricket in India (BCCI) formed?

- Ans
- 1. 1914
  - 2. 1931
  - 3. 1947
  - 4. 1928

## Combined Higher Secondary Level Examination 2024 Tier I

Exam Date	09/07/2024
Exam Time	5:15 PM - 6:15 PM
Subject	CHSL Exam 2024 Tier I

### Section : English Language

1. The given sentence is divided into four segments. Identify the segment that contains a grammatical error. A great / culture of hospitality of / the Spanish / is well-known.

Ans  1. the Spanish  
 2. culture of hospitality of  
 3. A great  
 4. is well-known.

2. The following sentence has been split into four segments. Identify the segment that contains a grammatical error. After a while, / she look up / and saw that / it was getting dark.

Ans  1. and saw that  
 2. it was getting dark  
 3. she look up  
 4. After a while

3. Parts of the following sentence have been given as options. Select the option that contains an error. There was an gang of thieves spotted at our local bank, make sure to be careful.

Ans  1. at our local bank  
 2. make sure to be careful  
 3. There was an gang  
 4. of thieves spotted

- Q.4 Select the option that will improve the given sentence by using the most appropriate verb. Alexa have being working as a teacher for five years now.

Ans  1. Alexa has been working as a teacher for five years now.  
 2. Alexa has being working as a teacher for five years now.  
 3. Alexa is being working as a teacher for five years now.  
 4. Alexa was been working as a teacher for five years now.

**Comprehension:**

In the following passage, some words have been deleted. Read the passage carefully and select the most appropriate option to fill in each blank.

How does a camel survive in the desert? Many people think that the camel stores water in its hump, but the hump is really made up of fats. When a camel (1)\_\_\_\_\_find water, it passes less urine to conserve (2)\_\_\_\_\_small amount of water it has in its body. Furthermore, the camel has a higher body temperature than (3)\_\_\_\_\_of most mammals. This means that it starts to sweat (4)\_\_\_\_\_a higher temperature than that which human beings, for example, (5)\_\_\_\_\_to perspire. This also helps it to keep water loss through sweating to a minimal.

**SubQuestion No : 5****Q.5 Select the most appropriate option to fill in blank number 1.**

- Ans
- 1. do not
  - 2. cannot
  - 3. hasn't
  - 4. can

**Comprehension:**

In the following passage, some words have been deleted. Read the passage carefully and select the most appropriate option to fill in each blank.

How does a camel survive in the desert? Many people think that the camel stores water in its hump, but the hump is really made up of fats. When a camel (1)\_\_\_\_\_find water, it passes less urine to conserve (2)\_\_\_\_\_small amount of water it has in its body. Furthermore, the camel has a higher body temperature than (3)\_\_\_\_\_of most mammals. This means that it starts to sweat (4)\_\_\_\_\_a higher temperature than that which human beings, for example, (5)\_\_\_\_\_to perspire. This also helps it to keep water loss through sweating to a minimal.

**SubQuestion No : 6****Q.6 Select the most appropriate option to fill in blank number 2.**

- Ans
- 1. the
  - 2. which
  - 3. a
  - 4. very

**Comprehension:**

In the following passage, some words have been deleted. Read the passage carefully and select the most appropriate option to fill in each blank.

How does a camel survive in the desert? Many people think that the camel stores water in its hump, but the hump is really made up of fats. When a camel (1)\_\_\_\_\_find water, it passes less urine to conserve (2)\_\_\_\_\_small amount of water it has in its body. Furthermore, the camel has a higher body temperature than (3)\_\_\_\_\_of most mammals. This means that it starts to sweat (4)\_\_\_\_\_a higher temperature than that which human beings, for example, (5)\_\_\_\_\_to perspire. This also helps it to keep water loss through sweating to a minimal.

**SubQuestion No : 7****Q.7 Select the most appropriate option to fill in blank number 3.**

- Ans
- 1. some
  - 2. the
  - 3. that
  - 4. all

**Comprehension:**

In the following passage, some words have been deleted. Read the passage carefully and select the most appropriate option to fill in each blank.

How does a camel survive in the desert? Many people think that the camel stores water in its hump, but the hump is really made up of fats. When a camel (1)\_\_\_\_\_find water, it passes less urine to conserve (2)\_\_\_\_\_small amount of water it has in its body. Furthermore, the camel has a higher body temperature than (3)\_\_\_\_\_of most mammals. This means that it starts to sweat (4)\_\_\_\_\_a higher temperature than that which human beings, for example, (5)\_\_\_\_\_to perspire. This also helps it to keep water loss through sweating to a minimal.

**SubQuestion No : 8****Q.8 Select the most appropriate option to fill in blank number 4.**

- Ans
- 1. in
  - 2. with
  - 3. at
  - 4. for

**Comprehension:**

In the following passage, some words have been deleted. Read the passage carefully and select the most appropriate option to fill in each blank.

How does a camel survive in the desert? Many people think that the camel stores water in its hump, but the hump is really made up of fats. When a camel (1)\_\_\_\_\_find water, it passes less urine to conserve (2)\_\_\_\_\_small amount of water it has in its body. Furthermore, the camel has a higher body temperature than (3)\_\_\_\_\_of most mammals. This means that it starts to sweat (4)\_\_\_\_\_a higher temperature than that which human beings, for example, (5)\_\_\_\_\_to perspire. This also helps it to keep water loss through sweating to a minimal.

**SubQuestion No : 9**

**Q.9** Select the most appropriate option to fill in blank number 5.

- Ans
- 1. started
  - 2. start
  - 3. starting
  - 4. starts

**Q.10** Select the most appropriate option to substitute the underlined segment in the given sentence.

Shantanu always buries his head in the sand whenever he explains his professional failures to his father.

- Ans
- 1. hides from the truth
  - 2. shows a blind eye against social issues
  - 3. escapes from all the difficulties
  - 4. blames the others for his mistakes

**Q.11** Select the most appropriate option to fill in the blank.

The cat's entry into the store room was \_\_\_\_\_.

- Ans
- 1. quite
  - 2. quiet
  - 3. cute
  - 4. quit

**Q.12** Select the most appropriate option to fill in the blank.

The \_\_\_\_\_ of the whale is 2 tonnes.

- Ans
- 1. wait
  - 2. weight
  - 3. vet
  - 4. wet

**Q.13** Select the most appropriate option that can substitute the underlined segment in the given sentence.

Grasslands should not be foraged and some places are to be closed for grazing.

- Ans
- 1. over-grazed and some areas should be
  - 2. cut and few areas
  - 3. grazed and some places is
  - 4. planted or

**Q.14** Select the most appropriate option that can substitute the underlined segment in the given sentence.  
Things that do not come from the ground not safe to compost.

- Ans
- 1. has not been safe
  - 2. are not safe
  - 3. is not safe
  - 4. be not safe

Q.15 Select the most appropriate meaning of the underlined idiom in the given sentence.  
He got medals time after time by following the instructions of his mentor.

- Ans
- 1. Repeatedly
  - 2. Twice
  - 3. Rarely
  - 4. Once

Q.16 Select the most appropriate option that can substitute the underlined segment in the given sentence. If there is no need to substitute it, select 'No substitution required'.  
I quietly went out at the door into the veranda.

- Ans
- 1. No substitution required
  - 2. by
  - 3. through
  - 4. from

Q.17 Select the option with the correct spelling to replace the underlined word in the given sentence.  
A natural clamity causing huge destruction and loss of life and property.

- Ans
- 1. calamity
  - 2. clamanity
  - 3. calamitey
  - 4. climanity

Q.18 Select the most appropriate ANTONYM of the underlined word.  
We should not run after transient pleasures of the world.

- Ans
- 1. Unnatural
  - 2. Sinful
  - 3. Permanent
  - 4. Joyful

Q.19 Select the most appropriate synonym of the given word.  
Luminous

- Ans
- 1. Radiant
  - 2. Laborious
  - 3. Luxurious
  - 4. Amiable

Q.20 Select the most appropriate option that can substitute the underlined word in the given sentence.  
Modest stores and welcoming residents populated the charming tiny town.

- Ans
- 1. delightful
  - 2. unpleasant
  - 3. hideous
  - 4. nasty

Q.21 Select the INCORRECTLY spelt word in the given sentence.  
King Zheng is known to lead an army of a million armoured soldiers, a thousand chariots and ten thousand horses in his mission to conquer the neighbouring kingdoms.

- Ans
- 1. Misssion
  - 2. Kingdoms
  - 3. Chariots
  - 4. Thousand

Q.22 Fill in the blank with the most appropriate ANTONYM of the underlined word.

In spring the leaves are bright green, whereas they appear \_\_\_\_\_ in autumn.

- Ans
- 1. gleaming
  - 2. luminous
  - 3. dazzling
  - 4. dull

Q.23 Select the most appropriate option to fill in the blank.

It is the \_\_\_\_\_ to reach Delhi.

- Ans
- 1. lowest route
  - 2. strongest route
  - 3. quickest route
  - 4. fastest route

Q.24 Identify the most appropriate ANTONYM of the underlined word in the following sentence.

Harry's behaviour was very blunt during his school days.

- Ans
- 1. Excited
  - 2. Polite
  - 3. Dull
  - 4. Curious

Q.25 Select the most appropriate synonym of the given word.

Rectify

- Ans
- 1. Connect
  - 2. Consider
  - 3. Correct
  - 4. Count

Section : General Intelligence

Q.1 What will come in the place of the question mark (?) in the following equation, if '+' and '-' are interchanged and '×' and '÷' are interchanged?

$$16 \div 5 - 24 \times 6 + 3 = ?$$

- Ans
- 1. 82
  - 2. 85
  - 3. 80
  - 4. 81

Q.2 How many rectangles are there in the given figure?

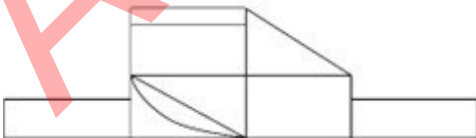

- Ans
- 1. 8
  - 2. 9
  - 3. 10
  - 4. 11

Q.3 What will come in the place of the question mark (?) in the following equation, if '+' and '-' are interchanged and '×' and '÷' are interchanged?

$$14 - 15 \div 2 + 56 \times 14 = ?$$

- Ans
- 1. 40
  - 2. 35
  - 3. 45
  - 4. 30

Q.4 What should come in place of the question mark (?) in the given series based on the English alphabetical order?  
CEG, FHJ, IKM, LNP, ?

- Ans
- 1. OQS
  - 2. QTV
  - 3. OQR
  - 4. QRS

Q.5 What should come in place of the question mark (?) in the given series based on the English alphabetical order?

RPM, USP, XVS, AYV, ?

- Ans
- 1. BDY
  - 2. DYB
  - 3. BYD
  - 4. DBY

Q.6 In a certain code language, 'BACK' is coded as '4162' and 'CAB' is coded as '214'. What is the code for 'K' in that language?

- Ans
- 1. 2
  - 2. 1
  - 3. 4
  - 4. 6

Q.7 Six letters A, R, T, W, Y and Z are written on different faces of a dice. Two positions of this dice are shown in the figure. Which is the letter on the face opposite to the face containing A?



- Ans
- 1. Z
  - 2. W
  - 3. Y
  - 4. R

Q.8 If 10 days before was a Sunday and 6 days after would be a Tuesday, then what day is it today?

- Ans
- 1. Wednesday
  - 2. Monday
  - 3. Friday
  - 4. Tuesday



Q.9 The position of how many letters will remain unchanged if each of the letters in the word WANDERLUST is arranged from left to right in alphabetical order?

- Ans
- 1. Three
  - 2. One
  - 3. None
  - 4. Two

Q.10 Select the correct mirror image of the given figure when the mirror is placed at MN as shown below.

W P Q J K 2 G E

M ————— N

- Ans
- 1. W Ъ Ɔ 1 K 5 Ɔ E
  - 2. W ɹ ɹ 1 Ɔ K 5 Ɔ E
  - 3. W Ъ Ɔ 1 K 2 Ɔ E
  - 4. E Ɔ 5 K 1 Ɔ 9 W

Q.11 In a certain code language, 'time and again' is coded as 'zx df mo' and 'value your time' is coded as 'df pn tv'. How is 'time' coded in the given language?

- Ans
- 1. mo
  - 2. df
  - 3. tv
  - 4. zx

Q.12 What will come in the place of the question mark (?) in the following equation, if '+' and '-' are interchanged and '×' and '÷' are interchanged?

$$15 \div 4 - 128 + 123 \times 3 = ?$$

- Ans
- 1. 187
  - 2. 147
  - 3. 167
  - 4. 127

Q.13 Read the given statements and conclusions carefully. Assuming that the information given in the statements is true, even if it appears to be at variance with commonly known facts, decide which of the given conclusions logically follow(s) from the statements.

Statements:

Some sweaters are jackets.

Some jackets are pullovers.

No pullover is a glove.

Conclusions:

(I) No jacket is a glove.

(II) Some sweaters are pullovers.

- Ans
- 1. Only conclusion I follows
  - 2. Only conclusion II follows
  - 3. None of the conclusions follow
  - 4. Both conclusions I and II follow

Q.14 Select the word-pair that best represents a similar relationship to the one expressed in the pair of words given below. (The words must be considered as meaningful English words and must not be related to each other based on the number of letters/number of consonants/vowels in the word.)

Referee : Field

- Ans
- 1. Arbitrator : Deadlock
  - 2. Judge : Courtroom
  - 3. Experimenter : Result
  - 4. Gladiator : Ring

Q.15 Select the option figure in which the given figure (X) is embedded as its part (rotation is NOT allowed).



(X)

Ans

- 1.
- 2.
- 3.
- 4.

Q.16 33 is related to 726 by certain logic. Following the same logic, 43 is related to 946. To which of the following is 53 related, following the same logic?

(NOTE: Operations should be performed on the whole numbers, without breaking down the numbers into its constituent digits. E.g. 13 – Operations on 13 such as adding/subtracting/multiplying etc. to 13 can be performed. Breaking down 13 into 1 and 3 and then performing mathematical operations on 1 and 3 is not allowed.)

- Ans
- 1. 846
  - 2. 980
  - 3. 1060
  - 4. 1166

Q.17 Select the correct mirror image of the given combination when the mirror is placed at MN as shown below.

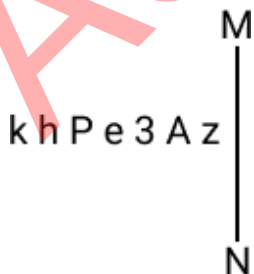

- Ans
- 1. z A e 9 P k
  - 2. z v e 9 P k
  - 3. z 3 A e P k
  - 4. z A e 9 P k

Q.18 Select the set in which the numbers are related in the same way as are the numbers of the following sets.  
(NOTE: Operations should be performed on the whole numbers, without breaking down the numbers into its constituent digits. E.g. 13 – Operations on 13 such as adding/deleting/multiplying etc. to 13 can be performed. Breaking down 13 into 1 and 3 and then performing mathematical operations on 1 and 3 is not allowed.)  
(6, 12, 72)  
(8, 16, 96)

- Ans
- 1. (7, 28, 144)
  - 2. (12, 24, 140)
  - 3. (12, 24, 144)
  - 4. (11, 24, 144)

Q.19 'T + W' means 'T is the father of W'  
'T - W' means 'T is the wife of W'  
'T × W' means 'T is the brother of W'  
'T ÷ W' means 'T is the daughter of W'.  
What does 'S + T ÷ U' mean?

- Ans
- 1. S is the husband of U
  - 2. S is the uncle of U
  - 3. S is the son of U
  - 4. S is the brother of U

Q.20 Which of the following numbers will replace the question mark (?) in the given series?  
112 113 122 147 196 ?

- Ans
- 1. 282
  - 2. 277
  - 3. 294
  - 4. 253

Q.21 What should come in place of the question mark (?) in the given series?  
3, 7, 15, 31, 63, ?

- Ans
- 1. 125
  - 2. 126
  - 3. 127
  - 4. 128

Q.22 Select the option figure in which the given figure (X) is embedded as its part (rotation is NOT allowed).

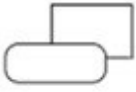

(X)

Ans

✗ 1.

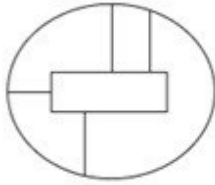

✓ 2.

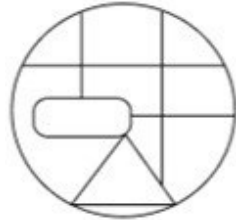

✗ 3.

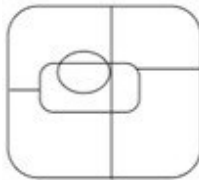

✗ 4.

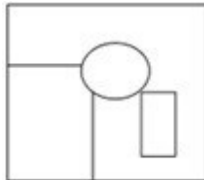

Q.23 Based on the alphabetical order, three of the following four letter-clusters are alike in a certain way and thus form a group. Which letter-cluster does not belong to that group?

(Note: The odd one out is not based on the number of consonants/vowels or their position in the letter cluster.)

Ans ✗ 1. PRT

✓ 2. TVY

✗ 3. RTV

✗ 4. HJL

Q.24 DFIK is related to EGJL in a certain way based on the English alphabetical order. In the same way, GILN is related to HJMO. To which of the following is MORT related to, following the same logic?

Ans ✗ 1. NQSU

✗ 2. NPSV

✗ 3. NPVS

✓ 4. NPSU

Q.25 Identify the figure in the options that when put in place of the question mark (?) will logically complete the series?

$\begin{array}{c} 4 \\ \times 8 \\ \hline 2 \end{array}$	$\begin{array}{c} 6 \\ \times 24 \\ \hline 4 \end{array}$	$\begin{array}{c} 8 \\ \times 48 \\ \hline 6 \end{array}$	$\begin{array}{c} 10 \\ \times 80 \\ \hline 8 \end{array}$	?
--	---	---	--	---

Ans

✗ 1.

$$\begin{array}{c} 12 \\ \times 2 \\ \hline 10 \end{array}$$

✓ 2.

$$\begin{array}{c} 12 \\ \times 120 \\ \hline 10 \end{array}$$

✗ 3.

$$\begin{array}{c} 14 \\ \times 140 \\ \hline 10 \end{array}$$

✗ 4.

$$\begin{array}{c} 12 \\ \times 22 \\ \hline 10 \end{array}$$

Section : Quantitative Aptitude

Q.1 Find the number of paper balls, each 2 cm in diameter, that can be made from a sphere of diameter 18 cm.

Ans ✗ 1. 1020

✗ 2. 625

✓ 3. 729

✗ 4. 484

Q.2 A shopkeeper sells an item at 20% discount on the marked price and earns a profit of 90%. If he sells the same item at 40% discount, then his new profit percentage will be:

Ans ✗ 1. 48.2%

✗ 2. 45.8%

✗ 3. 41.8%

✓ 4. 42.5%

Q.3

Study the following pie-chart carefully and answer the given question. The pie-chart represents the marks obtained by Sanya in different subjects in class 12. Total marks scored by her in class 12 was 450.

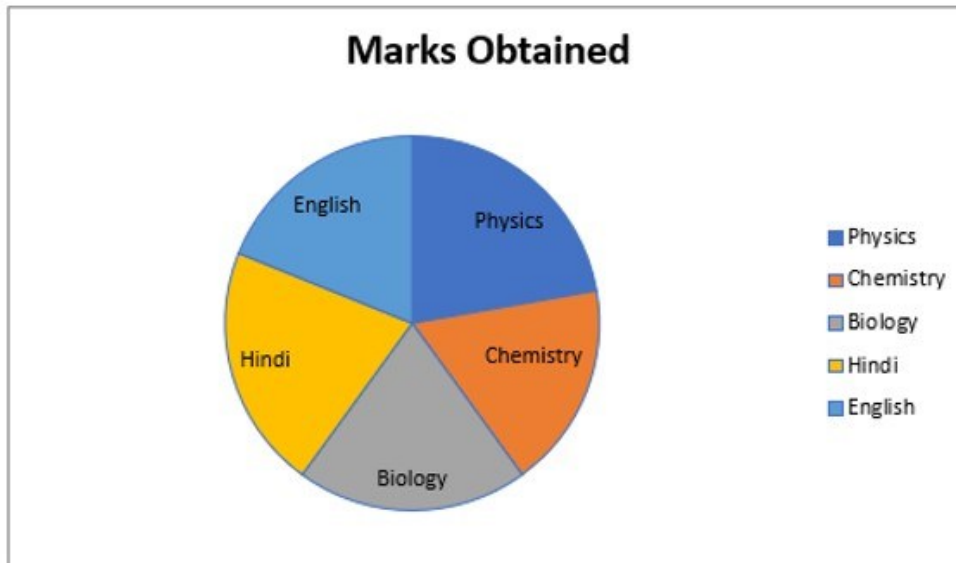

If the total central angles corresponding to the pair of subjects (Physics and Hindi), (Chemistry and Physics) and (Hindi and Chemistry) were  $156^\circ$ ,  $144^\circ$  and  $140^\circ$ , respectively, then find the total marks obtained by her in (English and Biology).

Ans  1. 175

2. 160

3. 180

4. 190

Q.4 Study the given pie charts and answer the question that follows.

Distribution of overseas tourists

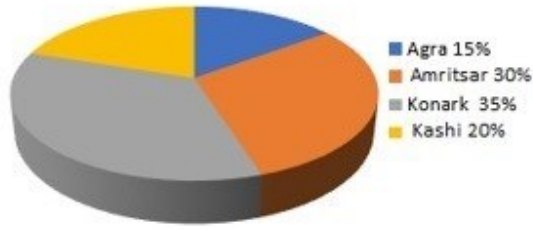

Age of tourists



If A = percentage of tourists who went to Agra, Amritsar and Kashi, and B = percentage of tourists whose age lies between 2 years to 50 years, then what is A:B?

- Ans
- 1. 10:7
  - 2. 10:13
  - 3. 13:10
  - 4. 11:13

Q.5 If 20% of 35% of a number is 240.8, then 18% of that number (rounded off to 1 decimal place) is:

- Ans
- 1. 619.2
  - 2. 618.2
  - 3. 621.2
  - 4. 623.2

Q.6 The following bar graph represents the percentage marks obtained in grade 9, 10, 11 and 12 students in Economics, English and History. Study the given bar graph carefully and answer the question that follows.

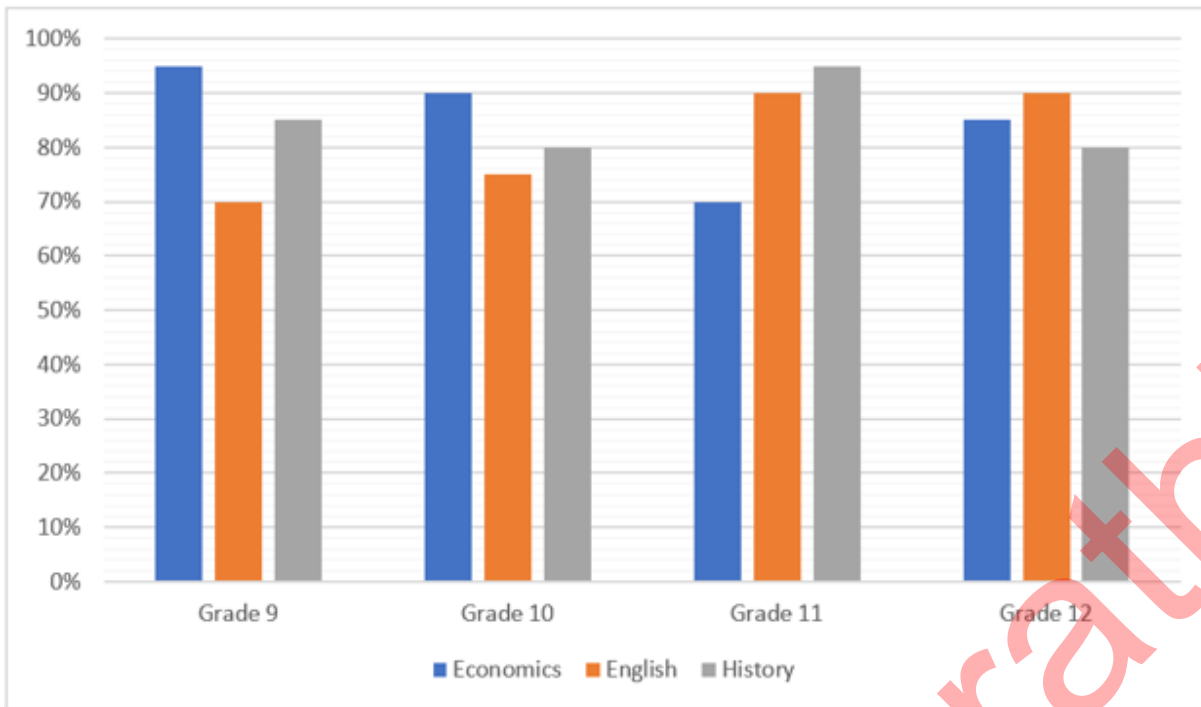

If the full marks in Economics is 100, English is 80 and History is 50, then find the total marks obtained by grade 10 students.

- Ans
- 1. 190
  - 2. 220
  - 3. 200
  - 4. 245

Q.7 A can finish a piece of work by working alone in 4 days. B, while working alone, can finish the same work in 12 days. If both of them work together, then in how many days will the work be completed?

- Ans
- 1. 8
  - 2. 6
  - 3. 3
  - 4. 4

Q.8 Simplify the following expression.

$$11\frac{1}{4} \div 3\frac{3}{5} \times 6\frac{2}{3} + \frac{1}{6} = \underline{\hspace{2cm}}$$

- Ans
- 1. 23
  - 2. 21
  - 3. 25
  - 4. 19

Q.9 In a circle with center O, the diameter AB extended to the point C, outside the circle. CD is a tangent at the point D on the circle. If the radius of circle is 6 cm and  $\angle DBC = 120^\circ$ , then the length of CD is equal to:

- Ans
- 1.  $5\sqrt{3}$  cm
  - 2.  $3\sqrt{3}$  cm
  - 3.  $6\sqrt{3}$  cm
  - 4.  $4\sqrt{3}$  cm



**Q.10** In a class with a certain number of students, if one student weighing 30 kg is added, then the average weight of the class increases by 1 kg. If one more student weighing 30 kg is added, then the average weight of the class increases by 1.5 kg over the original average. What is the original average weight (in kg) of the class?

- Ans**
- 1. 27
  - 2. 26.5
  - 3. 25.5
  - 4. 24

**Q.11** What is the maximum value of  $7 \cos A + 24 \sin A + 32$ ?

- Ans**
- 1. 57
  - 2. 32
  - 3. 25
  - 4. 39

**Q.12** The given table shows the percentage of marks obtained by 5 students in different subjects. Study the table and answer the question that follows. (Maximum marks are given beside subject).

Subjects →	Physics	Maths	Music	Hindi	Botany
Students ↓	300	300	100	100	200
Ram	60	80	90	60	95
Shyam	90	70	80	70	40
Sohan	70	90	95	80	75
Mohan	80	60	70	95	80
Karn	90	50	85	85	80

The marks obtained by Ram in Botany are less/more than Karn's marks in Botany by how much?

- Ans**
- 1. 25 less
  - 2. 30 more
  - 3. 25 more
  - 4. 30 less

**Q.13** The speed of a thief is  $\frac{4}{5}$  times the speed of a policeman. The thief covers a distance of 6 km before he was caught by the policeman in 30 minutes. Initially, what was the distance between the policeman and the thief in km?

- Ans**
- 1. 0.8
  - 2. 1.0
  - 3. 1.5
  - 4. 1.2

**Q.14** After decreasing 30%, an article costs Rs.3,500. Find its actual cost.

- Ans**
- 1. Rs.4,500
  - 2. Rs.6,500
  - 3. Rs.5,000
  - 4. Rs.5,500

Q.15 A metallic sphere of volume  $3136\pi \text{ cm}^3$  is melted and then, recast into smaller cones, each of radius 3.5 cm and height 4 cm. How many cones are obtained?

- Ans
- 1. 148
  - 2. 192
  - 3. 196
  - 4. 172

Q.16 In the diagram, if  $\overline{AB} \parallel \overline{CE}$ ,  $AG = GD = DH = HB$ , then which of the following is correct?

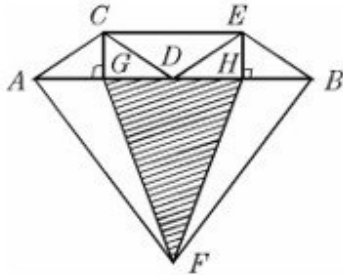

I)  $\triangle ACG \cong \triangle BEH$  II)  $\triangle CDE \cong \triangle DEB \cong \triangle DCA$  III)  $\triangle HFB \cong \triangle AFG$

- Ans
- 1. I and III
  - 2. I and II
  - 3. I, II and III
  - 4. Only I

Q.17 Simplify

$$\left[ 6 - 2 \left\{ 3 - 4 \left( 4 \div \frac{1}{4} - 1 \right) + 2 \div \frac{1}{3} \right\} - 3 \times 2 \right]$$

- Ans
- 1. 102
  - 2. 98
  - 3. 96
  - 4. 92

Q.18 If three sides of a triangle are 6 cm, 8 cm and 10 cm, then the area of the triangle is:

- Ans
- 1.  $30 \text{ cm}^2$
  - 2.  $12\sqrt{3} \text{ cm}^2$
  - 3.  $24 \text{ cm}^2$
  - 4.  $24\sqrt{3} \text{ cm}^2$

Q.19

Study the given pie-chart and answer the question that follows.

The pie-chart shows the monthly expenditure incurred by a family on various items and their savings.

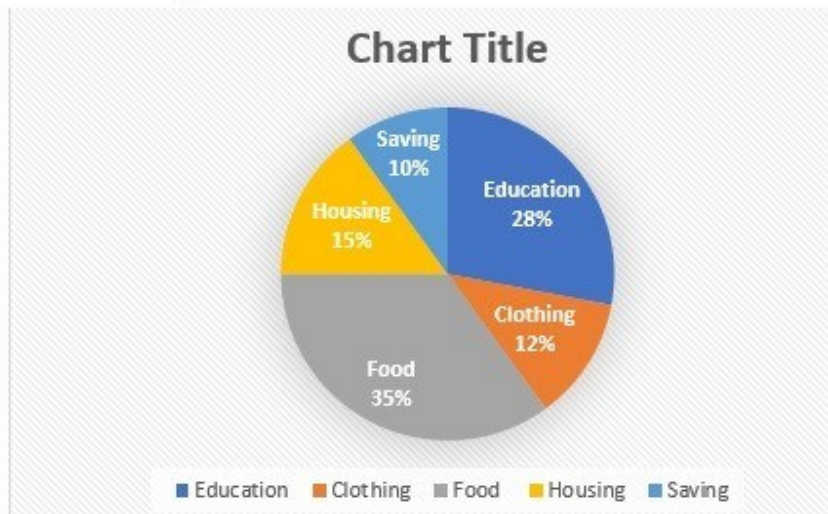

If the total expenditure on education is ₹23,520, then what is the expenditure on clothing (in ₹)?

- Ans
- 1. 10000
  - 2. 10080
  - 3. 12300
  - 4. 11000

Q.20 By selling 22 items, Rohit gains the selling price of 6 items. His gain per cent is:

- Ans
- 1.  $37\frac{1}{2}\%$
  - 2.  $37\frac{1}{3}\%$
  - 3.  $33\frac{1}{2}\%$
  - 4.  $33\frac{1}{3}\%$

Q.21 The price of an electronic watch is first reduced by 25% and then increased by 50%. If the resulting price of the electronic watch is ₹7,650, then what was its original price (in ₹)?

- Ans
- 1. 6,900
  - 2. 6,500
  - 3. 6,600
  - 4. 6,800

Q.22 By decreasing  $17^\circ$  from each angle of a triangle, the ratio of their angles is 3 : 4 : 7. The radian measure of the greatest angle is:

Ans

1.  $\frac{153\pi}{360}$

2.  $\frac{167\pi}{180}$

3.  $\frac{163\pi}{360}$

4.  $\frac{163\pi}{180}$

Q.23 The lengths of the three sides of a triangle are 19 cm, 25 cm and  $y$  cm. Which of the following options most accurately gives the possible values of 'y'?

Ans

1.  $6 \leq y < 44$

2.  $6 < y < 44$

3.  $6 \leq y \leq 44$

4.  $6 < y \leq 44$

Q.24 The strength of a school is 640, with the number of boys being 400. Find the ratio of girls to boys.

Ans

1. 8 : 5

2. 5 : 6

3. 4 : 5

4. 3 : 5

Q.25 What will be the amount due on ₹36,000 in 2 years when the rate of simple interest for successive years is 8% and 6%, respectively?

Ans

1. ₹38,880

2. ₹40,320

3. ₹41,760

4. ₹41,040

Section : General Awareness

1. Intervention by the monetary authority of a country in the money market to keep money supply stable against exogenous or sometimes external shocks is called \_\_\_\_.

Ans

1. sterilisation

2. capitalisation

3. conservation

4. neutralisation

2. In PPT What method can be used to move among slides if your hands are already on the keyboard?

Ans

1. Pressing the Esc key to exit the presentation

2. Using the keyboard directional keys

3. Scrolling with the mouse wheel

4. Clicking on the slide thumbnail in the Slides tab

Q.3 What was the name of the person who has been elected as the Chair of the 62<sup>nd</sup> session of the United Nations Commission for Social Development?

- Ans
- 1. Ruchira Kamboj
  - 2. Satinder Kumar Lambah
  - 3. BM Vinod Kumar
  - 4. Nirupama Menon Rao

Q.4 Which of the following is NOT an Olympics Sport? (As of March, 2023)

- Ans
- 1. Cricket
  - 2. Rowing
  - 3. Sailing
  - 4. 3×3 Basketball

Q.5 According to Census 2011, India's population accounts \_\_\_\_\_ of the world's population.

- Ans
- 1. 20%
  - 2. 15%
  - 3. 10%
  - 4. 17.5%

Q.6 Jharkhand and Chhattisgarh states are rich with \_\_\_\_\_ material deposits.

- Ans
- 1. gold
  - 2. silicon
  - 3. petroleum
  - 4. coal

Q.7 Fundamental duties were introduced in Part IVA of the Constitution by the:

- Ans
- 1. Forty-third Amendment Act, 1977
  - 2. Forty-first Amendment Act, 1976
  - 3. Forty-second Amendment Act, 1976
  - 4. Forty-fourth Amendment Act, 1978

Q.8 How does the CPU distinguish between each memory cell?

- Ans
- 1. By its address
  - 2. By its data item
  - 3. By its capacity
  - 4. By its byte size

Q.9 The Big Dipper is an asterism formed by the seven brightest stars in the constellation:

- Ans
- 1. Ursa Major
  - 2. Orion
  - 3. Cassiopeia
  - 4. Leo Major

Q.10 Aajeevika - National Rural Livelihoods Mission (NRLM) - was launched by the Ministry of Rural Development (MoRD), Government of India, in the year \_\_\_\_\_.

- Ans
- 1. 2013
  - 2. 2010
  - 3. 2012
  - 4. 2011

Q.11 Baiga is a folk music of Baiga Tribe from which of the following states?

- Ans
- 1. Uttarakhand
  - 2. Assam
  - 3. Bihar
  - 4. Madhya Pradesh

Q.12 The cell wall of bacteria is made up of:

- Ans
- 1. peptidoglycan
  - 2. cellulose
  - 3. glycogen
  - 4. peptone

Q.13 Which of the following Articles of the Indian Constitution are related to Fundamental Rights?

- Ans
- 1. 14-32
  - 2. 32-51
  - 3. 12-35
  - 4. 12-36

Q.14 According to rules laid down by the International Football Association Board (IFAB), what can be the maximum length of a goal line in football?

- Ans
- 1. 90 m
  - 2. 100 m
  - 3. 40 m
  - 4. 50 m

Q.15 What kind of a satellite is CMS-01, that was launched by ISRO in December 2020?

- Ans
- 1. Navigation
  - 2. Resource management
  - 3. Tsunami observation
  - 4. Communication

Q.16 Shattantri Veena, meaning a Veena with hundred strings, is the ancient Sanskrit name of which instrument?

- Ans
- 1. Tambura/Tanpura
  - 2. Sarangi
  - 3. Sarod
  - 4. Santoor

Q.17 Which party won the Jalandhar (a city in Punjab) Lok Sabha bypoll election held in May 2023?

- Ans
- 1. Indian National Congress
  - 2. Akali Dal
  - 3. Aam Aadmi Party
  - 4. Bharatiya Janata Party

Q.18 Which of the following date is observed as a national festival?

- Ans
- 1. 24 October
  - 2. 25 October
  - 3. 2 October
  - 4. 10 October

Q.19 Milk of magnesia is a suspension of \_\_\_\_\_ in water.

- Ans
- 1. magnesium oxalate
  - 2. magnesium hydroxide
  - 3. magnesium chlorate
  - 4. magnesium bromide

Q.20 Warren Hastings became the Governor-General of Bengal from Governor of Bengal after the passing of which of the following Acts?

- Ans
- 1. Indian Council Act of 1861
  - 2. Pitt's India Act, 1784
  - 3. Regulating Act, 1773
  - 4. Charter Act, 1813

Q.21 In a test match, the captain of the fielding side may demand a new ball after \_\_\_\_\_.

- Ans
- 1. 85 overs
  - 2. 80 overs
  - 3. 70 overs
  - 4. 75 overs

Q.22 Rouf is the traditional dance of \_\_\_\_\_, which is practiced on the festive occasions of Eid and during Ramzan days.

- Ans
- 1. Jammu & Kashmir
  - 2. Chandigarh
  - 3. Leh
  - 4. Puducherry

Q.23 In 1955, \_\_\_\_\_ noted the possibility of using small-scale industries for promoting rural development.

- Ans
- 1. Chakravarty Committee
  - 2. Sarkaria Committee
  - 3. Kelkar Committee
  - 4. Karve Committee

Q.24 The Union Cabinet, in Aug 2022, approved the enhancement in the limit of Emergency Credit Line Guarantee Scheme (ECLGS) by \_\_\_\_\_, with the additional amount being earmarked exclusively for enterprises in hospitality and related sectors.

- Ans
- 1. ₹10,000 crore
  - 2. ₹50,000 crore
  - 3. ₹60,000 crore
  - 4. ₹30,000 crore

Q.25 Who amongst the following Mughal emperors got classical Hindu mythological texts Ramayana and Mahabharata translated into Persian?

- Ans
- 1. Jahangir
  - 2. Aurangzeb
  - 3. Akbar
  - 4. Shahjahan

## Combined Higher Secondary Level Examination 2024 Tier I

Exam Date	10/07/2024
Exam Time	9:00 AM - 10:00 AM
Subject	CHSL Exam 2024 Tier I

### Section : English Language

1. The given sentence is divided into three segments. Select the option that has the segment with a grammatical error. If there is no error, select 'No error'.  
The volunteer gave on to / the food packets to the / children of the orphanage.

Ans  1. The volunteer gave on to  
 2. the food packets to the  
 3. No error  
 4. children of the orphanage.

2. The given sentence is divided into four segments. Select the option that has the segment with a grammatical error. It was my niece / who was leaving college / last year, and / not my son.

Ans  1. last year, and  
 2. not my son.  
 3. It was my niece  
 4. who was leaving college

3. Parts of the given sentence have been underlined. One of them contains an error. The underlined parts are given as options with some changes. Select the option that correctly rectifies the error.  
Raveena's daughter Kavya is most intelligent student and she consistently achieves top grades.

Ans  1. Raveenas' daughter  
 2. she has consistently  
 3. an intelligent  
 4. topper grades

- Q.4 Select the most appropriate option that can substitute the underlined segment in the given sentence.

UNICEF builds partnerships across the global community on accelerate gender equality.

Ans  1. global community with accelerate  
 2. global community till accelerate  
 3. global community to accelerate  
 4. global community in accelerate



**Comprehension:**

In the following passage, some words have been deleted. Select the most appropriate option for each blank.  
I was reading a book two days back. It was titled Charlie and the Chocolate Factory by Roland Dahl. It was fantastic. It has now become my favourite (1)\_\_\_\_\_. It is about a boy named Charlie who is (2) \_\_\_\_\_poor. He wins a golden ticket that (3) \_\_\_\_\_him to enter the most famous chocolate factory in the world. He (4) \_\_\_\_\_it with his grandfather. But the other kids who accompany him are nasty. They are all spoilt. But you have to read the book to (5) \_\_\_\_\_out more about them. The amazing part of the book is that it is like a dream come true.

**SubQuestion No : 5****Q.5** Select the most appropriate option to fill in blank no. 1.

- Ans
- 1. text
  - 2. guide
  - 3. book
  - 4. manual

**Comprehension:**

In the following passage, some words have been deleted. Select the most appropriate option for each blank.  
I was reading a book two days back. It was titled Charlie and the Chocolate Factory by Roland Dahl. It was fantastic. It has now become my favourite (1)\_\_\_\_\_. It is about a boy named Charlie who is (2) \_\_\_\_\_poor. He wins a golden ticket that (3) \_\_\_\_\_him to enter the most famous chocolate factory in the world. He (4) \_\_\_\_\_it with his grandfather. But the other kids who accompany him are nasty. They are all spoilt. But you have to read the book to (5) \_\_\_\_\_out more about them. The amazing part of the book is that it is like a dream come true.

**SubQuestion No : 6****Q.6** Select the most appropriate option to fill in blank no. 2.

- Ans
- 1. very
  - 2. nicely
  - 3. properly
  - 4. finally

**Comprehension:**

In the following passage, some words have been deleted. Select the most appropriate option for each blank.  
I was reading a book two days back. It was titled Charlie and the Chocolate Factory by Roland Dahl. It was fantastic. It has now become my favourite (1)\_\_\_\_\_. It is about a boy named Charlie who is (2) \_\_\_\_\_poor. He wins a golden ticket that (3) \_\_\_\_\_him to enter the most famous chocolate factory in the world. He (4) \_\_\_\_\_it with his grandfather. But the other kids who accompany him are nasty. They are all spoilt. But you have to read the book to (5) \_\_\_\_\_out more about them. The amazing part of the book is that it is like a dream come true.

**SubQuestion No : 7****Q.7** Select the most appropriate option to fill in blank no. 3.

- Ans
- 1. bears
  - 2. gets
  - 3. suffers
  - 4. allows

**Comprehension:**

In the following passage, some words have been deleted. Select the most appropriate option for each blank.  
I was reading a book two days back. It was titled Charlie and the Chocolate Factory by Roland Dahl. It was fantastic. It has now become my favourite (1)\_\_\_\_\_. It is about a boy named Charlie who is (2) \_\_\_\_\_poor. He wins a golden ticket that (3) \_\_\_\_\_him to enter the most famous chocolate factory in the world. He (4) \_\_\_\_\_it with his grandfather. But the other kids who accompany him are nasty. They are all spoilt. But you have to read the book to (5) \_\_\_\_\_out more about them. The amazing part of the book is that it is like a dream come true.

**SubQuestion No : 8****Q.8** Select the most appropriate option to fill in blank no. 4.

- Ans
- 1. examines
  - 2. explores
  - 3. visits
  - 4. inspects

### Comprehension:

In the following passage, some words have been deleted. Select the most appropriate option for each blank.  
I was reading a book two days back. It was titled Charlie and the Chocolate Factory by Roland Dahl. It was fantastic. It has now become my favourite (1)\_\_\_\_\_. It is about a boy named Charlie who is (2) \_\_\_\_\_poor. He wins a golden ticket that (3) \_\_\_\_\_him to enter the most famous chocolate factory in the world. He (4) \_\_\_\_\_it with his grandfather. But the other kids who accompany him are nasty. They are all spoilt. But you have to read the book to (5) \_\_\_\_\_out more about them. The amazing part of the book is that it is like a dream come true.

### SubQuestion No : 9

Q.9 Select the most appropriate option to fill in blank no. 5.

- Ans
- 1. find
  - 2. unlearn
  - 3. spot
  - 4. locate

Q.10 Select the most appropriate ANTONYM of the given word.  
Sluggish

- Ans
- 1. Hassled
  - 2. Lethargic
  - 3. Leisurely
  - 4. Rapid

Q.11 Select the most appropriate ANTONYM of the given word.  
Timid

- Ans
- 1. Resolute
  - 2. Blunt
  - 3. Audacious
  - 4. Assertive

Q.12 Select the most appropriate synonym of the given word.  
Retract

- Ans
- 1. Disturb
  - 2. Please
  - 3. Implement
  - 4. Revoke

Q.13 Select the option that will improve the underlined part of the given sentence.

Allusive handwriting creates a poor impression.

- Ans
- 1. Legal handwriting
  - 2. Eligible handwriting
  - 3. Descriptive handwriting
  - 4. Illegible handwriting

Q.14 Select the option that rectifies the spelling of the underlined word in the given sentence.  
It was a privilege to receive the award from the President.

- Ans
- 1. privilegge
  - 2. privilegee
  - 3. privilege
  - 4. privillege

Q.15 Select the sentence that brings out the most appropriate meaning of the idiom 'Dog in the manger'.

- Ans
- 1. Mohit was so loyal and committed to his company that he rejected lucrative offers from different companies.
  - 2. To prove this is not a trap, I want to check the credibility of your plan.
  - 3. Rachit had some important work and so he cancelled the show tickets for everyone.
  - 4. You are \_\_\_\_\_

Q.16 Select the most appropriate synonym of the given word.  
Alert

- Ans
- 1. Inactive
  - 2. Dull
  - 3. Smart
  - 4. Vigilant

Q.17 Select the most appropriate option to fill in the blank.

I find that students nowadays are not interested in \_\_\_\_\_ letters by hand.

- Ans
- 1. rioting
  - 2. rating
  - 3. writing
  - 4. righting

Q.18 Select the most appropriate synonym of the underlined word.  
For Rana, unable to see a thing, the parade seemed to last forever.

- Ans
- 1. hiding
  - 2. darkness
  - 3. concealment
  - 4. procession

Q.19 Select the most appropriate ANTONYM of the given word.  
Enormous

- Ans
- 1. Minute
  - 2. Strong
  - 3. Monstrous
  - 4. Tremendous

Q.20 Select the most appropriate option to correct the sentence by using the denotation of the underlined word.

Mr. Sen is clever enough to handle his professional hazards.

- Ans
- 1. Foolish
  - 2. Callous
  - 3. Intelligent
  - 4. Bold

Q.21 Select the option that will improve the underlined part of the given sentence. In case no improvement is needed, select No improvement required.  
Although uncountable files stack up on the tables of government officials, they prefer doing their work at a more leisure pace.

- Ans
- 1. at a more leisurely pace
  - 2. at a more leisure paced
  - 3. No improvement needed
  - 4. at a more leisurely paced

Q.22 Select the most appropriate meaning of the underlined idiom.

The technicians who were repairing the broken elevator called it a day.

- Ans
- 1. Felt unhappy
  - 2. Shouted with anger
  - 3. Stopped to take a short break
  - 4. Stopped work for the day

Q.23 Select the INCORRECTLY spelt word in the given sentence.

The Chinese are believed to have a longer history than that of any other civilisation in the world.

- Ans
- 1. World
  - 2. Civilisation
  - 3. Believed
  - 4. Chinese

Q.24 Select the most appropriate option that can replace the bracketed word segment in the following sentence. Classical buildings in ancient Greek and Roman times were (characteristically built) from marble or some other attractive, durable stone.

- Ans
- 1. typically built
  - 2. fascinating to build
  - 3. strange build
  - 4. mainly having been built

Q.25 Select the most appropriate option that can substitute the underlined segment in the given sentence.

The housing loan taken by Ramesh effected his daily expenses adversely.

- Ans
- 1. by Ramesh affected
  - 2. for Ramesh effected
  - 3. from Ramesh effected
  - 4. of Ramesh effected

Section : General Intelligence

Q.1 What should come in place of ? in the given series based on the English alphabetical order?

BJR ? RTH MYC HDX

- Ans
- 1. MOW
  - 2. OMW
  - 3. WOM
  - 4. OWM

2. The position of how many letters will remain unchanged if each of the letters in the word DOCUMENTARY is arranged from left to right in alphabetical order?

- Ans
- 1. Two
  - 2. Three
  - 3. None
  - 4. One

3. In a certain code language  
A + B means 'A is the mother of B'  
A - B means 'A is the brother of B'  
A × B means 'A is the husband of B'  
A ÷ B means 'A is the father of B'  
Based on the above, how is K related to L if 'K × Q + R - S ÷ L'?

- Ans
- 1. Father's father
  - 2. Father's mother's father
  - 3. Father's brother
  - 4. Father's father's brother

Q.4 Select the set in which the numbers are related in the same way as are the numbers of the following sets.  
 (NOTE : Operations should be performed on the whole numbers, without breaking down the numbers into its constituent digits. E.g. 13 – Operations on 13 such as adding / subtracting/multiplying etc. to 13 can be performed. Breaking down 13 into 1 and 3 and then performing mathematical operations on 1 and 3 is not allowed)  
 (5, 4, 41)  
 (7, 2, 53)

- Ans
- ✓ 1. (9, 3, 90)
  - ✗ 2. (10, 5, 130)
  - ✗ 3. (13, 6, 208)
  - ✗ 4. (11, 9, 204)

Q.5 Select the correct mirror image of the given figure when the mirror is placed at MN as shown below.

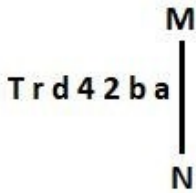

- Ans
- ✗ 1. s d 5 4 P r T
  - ✓ 2. s d 5 4 b 1 T
  - ✗ 3. s d 2 4 P 1 T
  - ✗ 4. e b 5 4 b 1 T

Q.6 How many quadrilaterals are there in the given figure?

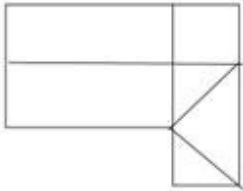

- Ans
- ✓ 1. 11
  - ✗ 2. 10
  - ✗ 3. 12
  - ✗ 4. 7

Q.7 Select the correct mirror image of the given figure when the mirror is placed at MN.

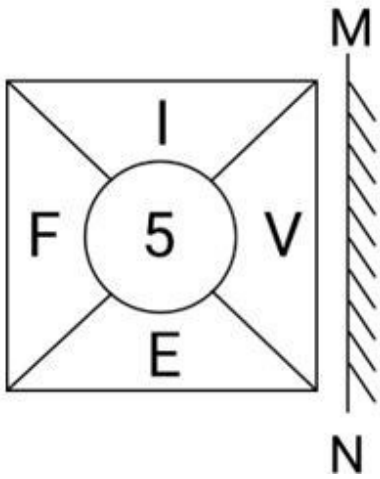

Ans

✗ 1.

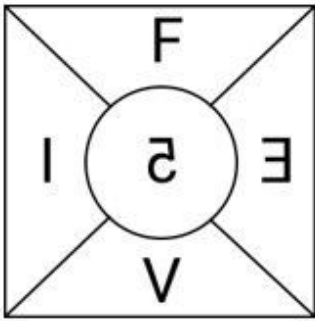

✗ 2.

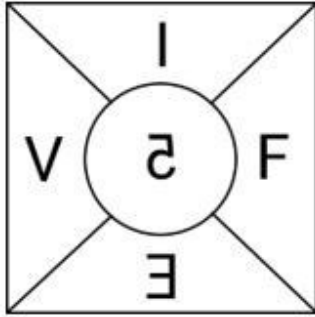

✓ 3.

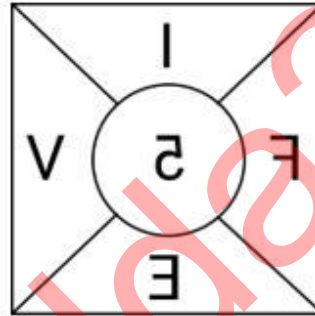

✗ 4.

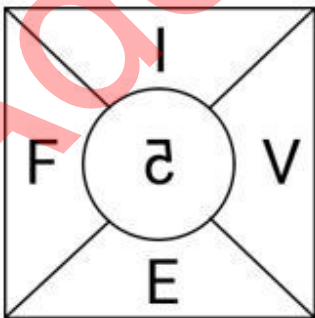

**Q.8** Select the word-pair that best represents a similar relationship to the one expressed in the pair of words given below. (The words must be considered as meaningful English words and must not be related to each other based on the number of letters/number of consonants/vowels in the word.)

Flower – Petal

**Ans**  1. Clarify – Explain

2. Fruit – Seed

3. Horse – Mare

4. Tiny – Large

**Q.9** Three statements are followed by conclusions numbered I, II. You have to consider these statements to be true, even if they seem to be at variance with commonly known facts. Decide which of the given conclusions logically follows from the given statement.

**Statements:**

All houses are trees.

All trees are stones.

All stones are rocks.

**Conclusion (I):** Some stones are trees.

**Conclusion (II):** All houses are rocks.

**Ans**  1. Neither conclusion (I) nor (II) follows.

2. Only conclusion (I) follows.

3. Both conclusions (I) and (II) follow.

4. Only conclusion (II) follows.

**Q.10** If 23 June 2008 was Monday, then what was the day of the week on 23 June 2020?

**Ans**  1. Wednesday

2. Saturday

3. Sunday

4. Tuesday

**Q.11** Select the letter-cluster pair that best represents a similar relationship to the one expressed in the pairs of letter-clusters given below.

VPN : ZTR

SMK : WQO

**Ans**  1. HDB : MIG

2. KFD : OJK

3. PMK : TOL

4. LFD : PJH

Q.12 Select the correct mirror image of the given figure when the mirror is placed at MN as shown below.

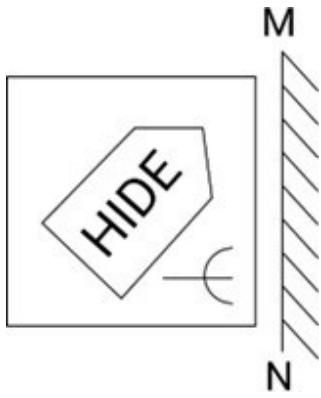

Ans

X 1.

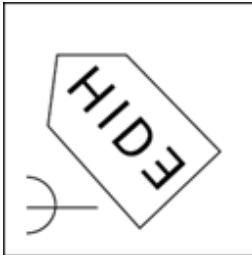

X 2.

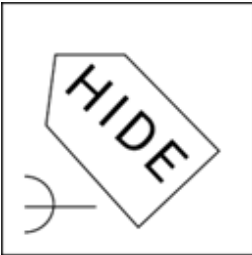

X 3.

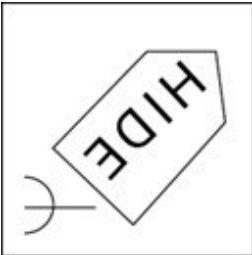

✓ 4.



Q.13 Which of the following numbers will replace the question mark (?) in the given series?

612 571 535 504 478 ?

Ans

X 1. 444

X 2. 435

✓ 3. 457

X 4. 468



Q.14 Three of the following four letter-clusters are alike in a certain way and thus form a group. Which is the one that does NOT belong to that group?

(Note: The odd one out is not based on the number of consonants/vowels or their position in the letter cluster.)

- 1) EFINU
- 2) BCFKR
- 3) JKNSZ
- 4) HIMQX

Ans  1. EFINU  
 2. HIMQX  
 3. JKNSZ  
 4. BCFKR

Q.15 If 'A' stands for '+', 'B' stands for '×', 'C' stands for '+' and 'D' stands for '-', then the resultant of which of the following will be 218?

Ans  1. 32 A 8 D 160 B 2 C 42  
 2. 32 B 8 D 160 C 2 A 42  
 3. 32 B 8 D 160 A 2 C 42  
 4. 32 C 8 D 160 A 2 B 42

Q.16 Select the correct mirror image of the given figure when the mirror is placed at MN as shown below.



Ans  1. TJZHBD  
 2. TSLBHD  
 3. TSLHBD  
 4. TSLHBD

Q.17 Which two numbers should be interchanged to make the given equation correct?

$$15 \times 5 - 75 + (300 \div 6) + 3 \times 19 = 115$$

(NOTE: Numbers must be interchanged and not the constituent digits e.g. if 2 and 3 are to be interchanged in the equation  $43 \times 3 + 4 \div 2$ , then interchanged equation is  $43 \times 2 + 4 \div 3$ )

Ans  1. 15 and 6  
 2. 15 and 19  
 3. 6 and 5  
 4. 6 and 3

Q.18 If 'A' stands for '+', 'B' stands for '×', 'C' stands for '+' and 'D' stands for '-', what will come in place of the question mark (?) in the following equation?

$$14 \text{ B } 11 \text{ D } 22 \text{ C } 328 \text{ A } 8 = ?$$

Ans  1. 153  
 2. 173  
 3. 133  
 4. 163

Q.19 In a certain code language, 'DIVERT' is coded as '36' and 'DOLDRUMS' is coded as '64'. What is the code for 'DOGMA' in the given code language?

- Ans
- 1. 36
  - 2. 25
  - 3. 49
  - 4. 64

Q.20 What should come in place of ? in the given series?

155 146 137 128 119 ?

- Ans
- 1. 133
  - 2. 110
  - 3. 122
  - 4. 111

Q.21 Which of the following letter-clusters can replace the question mark (?) in the given series to make it logically complete?  
AFK, ?, IXM, MTN, QPO

- Ans
- 1. FAE
  - 2. EBC
  - 3. FAL
  - 4. EBL

Adda247 Marathi

Q.22 Identify the figure given in the options that when put in place of the question mark (?) will logically complete the series.

T	=	9	0	S	T	T	0	S	9	♡	T	
	R		=			V			0			?
0	S	♡	♡	R	9	9	♡	R	R	V	S	

Ans

✓ 1.

T	9	♡
	2	
S	R	V

✗ 2.

♡	T	9
	2	
S	R	V

✗ 3.

R	V	9
	2	
S	♡	T

✗ 4.

T	9	♡
	2	
V	S	R

Adda247 Marathi

Q.23 A square sheet of paper is folded along the dotted line successively along the directions shown and is then punched in the last. How would the paper look when unfolded?

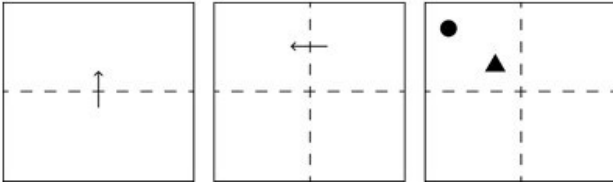

Ans

X 1.

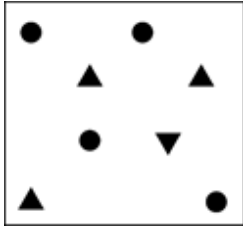

X 2.

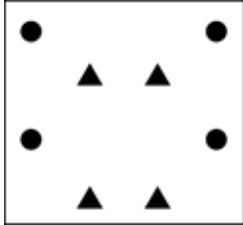

✓ 3.

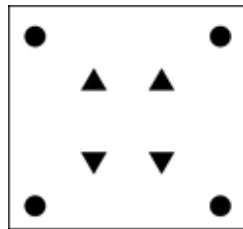

X 4.

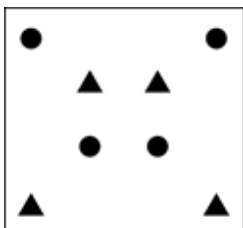

Q.24 In a certain code language, 'strength to innovate' is coded as '42 64 32' and 'strength to create' is coded as '32 42 24'. What is the code for 'create' in that language?

Ans

X 1. 32

X 2. 42

✓ 3. 24

X 4. 64

Q.25 92 is related to 23 following a certain logic. Following the same logic, 136 is related to 34. To which of the following is 224 related, following the same logic?

(NOTE: Operations should be performed on the whole numbers, without breaking down the numbers into its constituent digits. E.g. 13 – Operations on 13 such as adding /deleting /multiplying etc. to 13 can be performed. Breaking down 13 into 1 and 3 and then performing mathematical operations on 1 and 3 is not allowed)

Ans

X 1. 54

X 2. 58

X 3. 52

✓ 4. 56

Q.1 55 workers can finish a work in 16 days. For finishing the same work in 10 days, how many more workers are required?

- Ans
- 1. 68
  - 2. 33
  - 3. 88
  - 4. 31

Q.2 The radii of the two circles are 7 cm and 4 cm. If the distance between their centres is 25 cm, then the length of the transverse common tangent is equal to:

- Ans
- 1.  $6\sqrt{12}$  cm
  - 2.  $6\sqrt{11}$  cm
  - 3.  $6\sqrt{14}$  cm
  - 4.  $6\sqrt{13}$  cm

3. If the radius of a circle is 48 cm and the length of the arc is 15 cm, then the area of the sector corresponding to that arc is:

- Ans
- 1.  $860 \text{ m}^2$
  - 2.  $360 \text{ cm}^2$
  - 3.  $720 \text{ cm}^2$
  - 4.  $7200 \text{ m}^2$

Q.4 Read the given information and answer the question that follows.



If Company A makes 25% of income as profit in 2014, then its expenditure in that year is:

- Ans
- 1. ₹32 crores
  - 2. ₹30 crores
  - 3. ₹35 crores
  - 4. ₹40 crores

Q.5 A sum of ₹2,430 gives a simple interest of ₹1,093.50 in 3 years. The rate of interest per annum is:

- Ans
- 1. 20%
  - 2. 10%
  - 3. 15%
  - 4. 25%

Q.6 Raju and Ramu have more land than Sonu by 15% and 25%, respectively. What is the ratio of land owned by Raju and Ramu?

- Ans
- 1. 23 : 25
  - 2. 25 : 23
  - 3. 21 : 23
  - 4. 15 : 25

Q.7 A mirror is placed on the ground facing upwards. A man sees the top of a tower in the mirror which is at a distance of 105 m from the mirror. The man is 0.5 m away from the mirror, and his height is 1.5 m. Find the height of the tower (in metres).

- Ans
- 1. 315
  - 2. 115
  - 3. 210
  - 4. 280

Q.8 A cyclist rides 10 km at an average speed of 15 km/hr and then the next 15 km at an average speed of 10 km/hr. The average speed of the entire ride is:

- Ans
- 1. 20 km/hr
  - 2. 12.5 km/hr
  - 3. 10 km/hr
  - 4. 11.54 km/hr

Q.9 The total number of students in different subjects of a college and percentage of girls and boys are shown in the below table.

Girls students and boys student are NOT having multiple subjects.

Subjects	Number of Students	Girls %	Boys %
Mathematics	840	40	60
Chemistry	220	70	30
Physics	450	30	70
Biology	200	80	20

What is the percentage of girl students in the college?

- Ans
- 1. 45.2
  - 2. 46.9
  - 3. 45.9
  - 4. 42.9

Q.10 A person reaches his destination 30 minutes late, if his speed is 3 km/h, and reaches 30 minutes before time if his speed is 4 km/h. Find the distance of his destination from his starting point.

- Ans
- 1. 13 km
  - 2. 12 km
  - 3. 14 km
  - 4. 11 km

Q.11 To finish a work, P takes half of the number of days required by Q to finish it. If they together can finish the work in 36 days, then in how many days Q alone can finish the work?

- Ans
- 1. 108
  - 2. 84
  - 3. 60
  - 4. 24

Q.12 A patient in a hospital is given tea daily in a cylindrical cup of diameter 7 cm. If the cup is filled with tea to a height of 4 cm, how much tea the hospital has to prepare daily to serve 180 patients? (Use  $\pi = \frac{22}{7}$ )

- Ans
- 1. 22.27 litres
  - 2. 22.77 litres
  - 3. 27.27 litres
  - 4. 27.72 litres

Q.13 Simplify the following:

$$12 \div 4 \text{ of } 3 \times 6 + 8 \div 16 \text{ of } 4 \times 8 - 4 \div 6 \times 9$$

- Ans
- 1. 13
  - 2. -1
  - 3. 1
  - 4.  $6\frac{1}{4}$

Q.14 In an election between two candidates, A gets 63% of the total valid votes. If the total votes polled were 8,750, what is the number of valid votes that the other candidate B gets, if 20% of the total votes were declared invalid?

- Ans
- 1. 2,590
  - 2. 3,560
  - 3. 4,410
  - 4. 6,450

Q.15 If  $\tan A = \sqrt{2} - 1$  then find the value of  $\sin A \cos A + \tan A$ .

- Ans
- 1.  $\frac{24\sqrt{2} + 15}{4}$
  - 2.  $\frac{5\sqrt{2} - 4}{4}$
  - 3.  $\frac{24\sqrt{2} - 15}{4}$
  - 4.  $\frac{5\sqrt{2} + 4}{4}$

Q.16 The sum of the digits of a two-digit number is 9. If the digits are reversed, then the number is increased by 27. Find the number.

- Ans
- 1. 36
  - 2. 63
  - 3. 54
  - 4. 45

Q.17 A rectangle with the largest area is cut out of a circle with radius 5 units. What is the area of the remaining portion?

- Ans
- 1.  $25(2\pi - 3)$
  - 2.  $25(\pi - 2)$
  - 3.  $25(2\pi - 5)$
  - 4.  $25(\pi - 3)$

Q.18 A vendor sells his goods using weights 19% less than true weights and makes a profit of 35%. His net gain percentage (rounded off to 2 decimal places) is:

- Ans
- 1. 66.67%
  - 2. 66.33%
  - 3. 81.33%
  - 4. 81.67%

Q.19 The savings and expenditure of a family in a month on different heads is shown in the given pie chart. The family saves ₹8,000 per month.

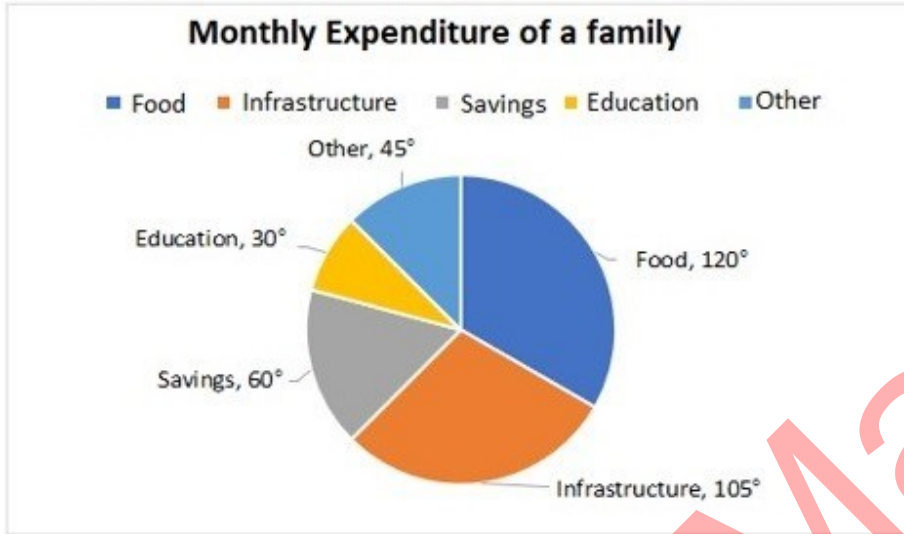

Find the ratio of the expenditure on food to that on savings.

- Ans
- 1. 3 : 1
  - 2. 5 : 1
  - 3. 4 : 1
  - 4. 2 : 1

Q.20 Four years ago, Ravi was four times as old as Kavya. Seven years from now, Ravi will be three times as old as Kavya. Find the sum of their present ages.

- Ans
- 1. 118 years
  - 2. 122 years
  - 3. 117 years
  - 4. 115 years

Q.21 Ram spends 30% of his salary on food, 10% on house rent, 7% on entertainment, and 6% on conveyance. If at the end of a month his savings are ₹1,880, then his monthly salary is:

- Ans
- 1. ₹4,500
  - 2. ₹4,000
  - 3. ₹5,000
  - 4. ₹5,500



Q.22

Study the given pie charts and answer the question that follows.

Distribution of overseas tourists

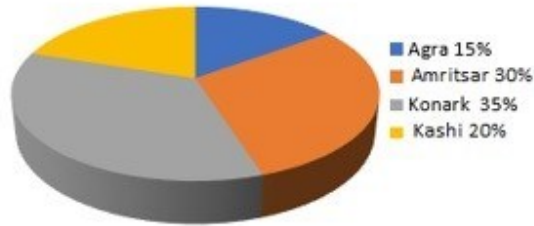

Age of tourists



What percentage of tourists went to Agra and Kashi?

- Ans
- 1. 20%
  - 2. 17.5%
  - 3. 35%
  - 4. 15%

Q.23 A cuboidal water purifier can carry 10 litres of water. Its breadth is  $\frac{1}{5}$  of its height and length is  $\frac{1}{3}$  of the sum of the breadth and height. The height of the tank is:

- Ans
- 1. 80 cm
  - 2. 10 cm
  - 3. 20 cm
  - 4. 50 cm

Q.24  $(8^6 + 1)$  when divided by 7, would leave a remainder of:

- Ans
- 1. 4
  - 2. 6
  - 3. 1
  - 4. 2

Q.25 R wishes to use a stick of length 6 units as common internal tangent to two circles of radius two units and three units. What can be the maximum distance (in units) between the centres of the circle?

- Ans
- 1.  $\sqrt{67}$
  - 2.  $\sqrt{61}$
  - 3.  $\sqrt{33}$
  - 4.  $\sqrt{37}$

1. National Sports Day is celebrated on the birthday of \_\_\_\_\_.

- Ans
- 1. Roop Singh
  - 2. Kapil Dev
  - 3. MS Dhoni
  - 4. Major Dhyan Chand

2. What is the duration of International hockey match?

- Ans
- 1. 50 min
  - 2. 55 min
  - 3. 70 min
  - 4. 60 min

Q.3 In which year was the National Human Rights Commission established in India?

- Ans
- 1. 2005
  - 2. 1993
  - 3. 1995
  - 4. 2003

Q.4 In 1812, who described the hypothesis that equal volumes of different gases contain an equal number of molecules?

- Ans
- 1. Amedeo Avogadro
  - 2. James Watt
  - 3. John Dalton
  - 4. Albert Einstein

Q.5 In which year did the Bhopal gas tragedy occur?

- Ans
- 1. 1988
  - 2. 1982
  - 3. 1985
  - 4. 1984

Q.6 Which of the following Fundamental Rights is available for Indians as well as foreigners?

- Ans
- 1. Right of minorities to establish and administer educational institutions
  - 2. Equality of opportunity in matters of public employment
  - 3. Right to protection of language, script and culture of minorities
  - 4. Right to elementary education

Q.7 In addition to using the arrow keys and mouse clicks, what other method can be used to move around a table in Microsoft Word?

- Ans
- 1. Right-clicking on the cell and selecting 'Move to Next Cell'
  - 2. Pressing the 'Enter' key or using the scroll wheel
  - 3. Using the Tab key or double-clicking on the cell
  - 4. Pressing the 'Ctrl' key and clicking on the cell

**Q.8** On 2 March 2023, the Supreme Court delivered an order on appointments to the Election Commission. According to this order, appointments will be done under the recommendation of a committee having which of the following members?

- Ans**
- 1. Prime Minister, Chief Justice of India and Speaker of the Lok Sabha
  - 2. Prime Minister, Leader of the opposition and Chairman Rajya Sabha
  - 3. Prime Minister, Leader of the opposition and Speaker of the Lok Sabha
  - 4. Prime Minister, Leader of the opposition and Chief Justice of India

**Q.9** Which of the following persons was appointed Chairman of the Second National Judicial Pay Commission?

- Ans**
- 1. Justice JS Verma
  - 2. Justice AS Anand
  - 3. Justice PV Reddi
  - 4. Justice R Basant

**Q.10** Identify a carbohydrate but does not fit into the definition.

- Ans**
- 1. Maltose
  - 2. Sucrose
  - 3. Fructose
  - 4. Rhamnose

**Q.11** A constellation of the northern sky easily recognised by a group of five bright stars forming a slightly irregular 'W' is called:

- Ans**
- 1. Cygnus
  - 2. Cassiopeia
  - 3. Ursa Major
  - 4. Orion

**Q.12** Which revolutionary organisation was established at Feroz Shah Kotla in New Delhi in 1928?

- Ans**
- 1. Indian Home Rule Society
  - 2. Bharat Naujawan Sabha
  - 3. Hindustan Socialist Republican Association
  - 4. Swadesh Bandhab Samiti

**Q.13** Which of the following is NOT a characteristics of the National Investment and Manufacturing Zones (NIMZs) of India? **Ans**

- 1. The state government will provide power connectivity, water and other infrastructural facilities.
- 2. A special purpose vehicle will be constituted to take care of the functioning of NIMZs.
- 3. It prescribes a minimum area of 10000 hectares for establishing NIMZs.
- 4. At least 30% of the total land area proposed for the NIMZ is to be utilized for manufacturing units.

**Q.14** In MS Word, which icon from the icons below the Menu Bar is commonly used to save the current document?

- Ans**
- 1. The envelope icon
  - 2. The floppy disk icon
  - 3. The printer icon
  - 4. The undo icon

Q.15 Which of the following statements is INCORRECT about the Music of India?

Ans  1. Tala is a cyclic arrangement of time units.

2. The musical instrument Kamaicha is majorly used by the 'Manganiar' Community of Manipur as a popular accompaniment to their songs

3. A raga is believed to have started as a tribal or folk tune.

4. The sruti is a unit of measure or small difference between the various consecutive pitches within a grama or a scale.

Q.16 Which of the following teams won the Indian Super League 2022-23?

Ans  1. AKT Mohun Bagan

2. Hyderabad FC

3. Bengaluru FC

4. Mumbai City FC

Q.17 Which of the following states is famous for celebrating the festival of Vijaya Dashami, which marks the end of Durga Puja?

Ans  1. Telengna

2. West Bengal

3. Rajasthan

4. Chhattisgarh

Q.18 Which of the following is/are an example of public goods?

a) Defense

b) House

Ans  1. Only b

2. Both a and b

3. Only a

4. Neither a nor b

Q.19 Consider the following:

Which of the following reasons may be considered as India's pull factors for migration?

1) Labour demand

2) Natural disaster

3) Protection of human and civil rights

4) High consumption and living standards

Ans  1. Only 2

2. Both 1 and 4

3. Only 2, 3 and 4

4. Only 1, 3 and 4

Q.20 In which of the following states is the Sanchi Stupa UNESCO world heritage site located?

Ans  1. Punjab

2. Bihar

3. Rajasthan

4. Madhya Pradesh

Q.21 The Himalayas' outermost range is called \_\_\_\_\_.

- Ans
- 1. Kanchenjunga
  - 2. Dhauladhar
  - 3. Pir Panjal
  - 4. Shivaliks

Q.22 Which of the following statements about Akbar are true?  
1 He introduced the Mansabdari system.  
2 He defeated and merged the state of Bijapur in his empire.  
3 He made Fatehpur Sikri his capital.

- Ans
- 1. Only 1 and 2
  - 2. All 1, 2, 3
  - 3. Only 2 and 3
  - 4. Only 1 and 3

Q.23 Which of the following Amendment Acts led to the insertion of Article 21 A?

- Ans
- 1. Eighty-seventh Amendment Act, 2003
  - 2. Eighty-sixth Amendment Act, 2002
  - 3. Eighty-fourth Amendment Act, 2002
  - 4. Eighty-fifth Amendment Act, 2002

Q.24 Rukmini Devi Arundale is associated with which art form?

- Ans
- 1. Mural
  - 2. Painting
  - 3. Kalaripayattu
  - 4. Dance

Q.25 Where is the renowned Bhatkhande music institute located?

- Ans
- 1. Lucknow
  - 2. Chennai
  - 3. Surat
  - 4. Madurai

## Combined Higher Secondary Level Examination 2024 Tier I

Exam Date	10/07/2024
Exam Time	11:45 AM - 12:45 PM
Subject	CHSL Exam 2024 Tier I

### Section : English Language

**Q.1** The following sentence has been divided into four parts. Identify the part that contains an error.  
(A) It is sad / (B) that you / (C) are believing / (D) in superstitious rituals.

- Ans**
- 1. A
  - 2. C
  - 3. B
  - 4. D

**2.** The following sentence has been split into four segments. Identify the segment that contains a grammatical error. Since childhood, Monty / ate his food / fast and he / will not change.

- Ans**
- 1. fast and he
  - 2. ate his food
  - 3. Since childhood, Monty
  - 4. will not change

**3.** The following sentence has been divided into four segments. Identify the segment that contains a grammatical error.  
After your insistence, / my sister / checked / a mailbox again.

- Ans**
- 1. a mailbox again.
  - 2. After your insistence,
  - 3. my sister
  - 4. checked

**Q.4** The following sentence has been split into four segments. Identify the segment that contains a grammatical error.  
In order to connect / these themes to a wider / historical context, Rahul go / beyond aesthetic analysis.

- Ans**
- 1. In order to connect
  - 2. beyond aesthetic analysis
  - 3. these themes to a wider
  - 4. historical context, Rahul go

**Comprehension:**

In the following passage, some words have been deleted. Read the passage carefully and select the most appropriate option to fill in each blank.

There is nothing more (1)\_\_\_\_\_ than when you sit down at your table to study with the most sincere of intentions and instead of being able to finish the task at hand you find your thoughts (2)\_\_\_\_\_. However, there are certain techniques that you can use to (3)\_\_\_\_\_ your concentration. To begin with, one should (4)\_\_\_\_\_ to create the physical environment that is conducive to (5)\_\_\_\_\_ thought.

**SubQuestion No : 5**

**Q.5 Select the most appropriate option to fill in blank no. 1**

- Ans**
- 1. frustrating
  - 2. exciting
  - 3. interesting
  - 4. surprising

**Comprehension:**

In the following passage, some words have been deleted. Read the passage carefully and select the most appropriate option to fill in each blank.

There is nothing more (1)\_\_\_\_\_ than when you sit down at your table to study with the most sincere of intentions and instead of being able to finish the task at hand you find your thoughts (2)\_\_\_\_\_. However, there are certain techniques that you can use to (3)\_\_\_\_\_ your concentration. To begin with, one should (4)\_\_\_\_\_ to create the physical environment that is conducive to (5)\_\_\_\_\_ thought.

**SubQuestion No : 6**

**Q.6 Select the most appropriate option to fill in blank no. 2.**

- Ans**
- 1. wandering
  - 2. interesting
  - 3. tiring
  - 4. worrying

**Comprehension:**

In the following passage, some words have been deleted. Read the passage carefully and select the most appropriate option to fill in each blank.

There is nothing more (1)\_\_\_\_\_ than when you sit down at your table to study with the most sincere of intentions and instead of being able to finish the task at hand you find your thoughts (2)\_\_\_\_\_. However, there are certain techniques that you can use to (3)\_\_\_\_\_ your concentration. To begin with, one should (4)\_\_\_\_\_ to create the physical environment that is conducive to (5)\_\_\_\_\_ thought.

**SubQuestion No : 7**

**Q.7 Select the most appropriate option to fill in blank no. 3.**

- Ans**
- 1. enhance
  - 2. commit
  - 3. discover
  - 4. convince

**Comprehension:**

In the following passage, some words have been deleted. Read the passage carefully and select the most appropriate option to fill in each blank.

There is nothing more (1)\_\_\_\_\_than when you sit down at your table to study with the most sincere of intentions and instead of being able to finish the task at hand you find your thoughts (2)\_\_\_\_\_. However, there are certain techniques that you can use to (3)\_\_\_\_\_your concentration. To begin with, one should (4)\_\_\_\_\_to create the physical environment that is conducive to (5)\_\_\_\_\_thought.

**SubQuestion No : 8**

**Q.8** Select the most appropriate option to fill in blank no. 4.

- Ans**
- 1. attempt
  - 2. imagine
  - 3. announce
  - 4. lead

**Comprehension:**

In the following passage, some words have been deleted. Read the passage carefully and select the most appropriate option to fill in each blank.

There is nothing more (1)\_\_\_\_\_than when you sit down at your table to study with the most sincere of intentions and instead of being able to finish the task at hand you find your thoughts (2)\_\_\_\_\_. However, there are certain techniques that you can use to (3)\_\_\_\_\_your concentration. To begin with, one should (4)\_\_\_\_\_to create the physical environment that is conducive to (5)\_\_\_\_\_thought.

**SubQuestion No : 9**

**Q.9** Select the most appropriate option to fill in blank no. 5.

- Ans**
- 1. focussed
  - 2. joyful
  - 3. cautious
  - 4. dazzling

**Q.10** Select the most appropriate meaning of the underlined idiom in the following sentence.  
Manish told Rounak time and again of the ill consequences of his habit of being late to the college.

- Ans**
- 1. Repeatedly
  - 2. Hardly ever
  - 3. At intervals
  - 4. Not often

**Q.11** Select the most appropriate option to fill in the blank.

Seema has a dominating nature, so she wants to \_\_\_\_\_ of everything in her life.

- Ans**
- 1. keep touch
  - 2. keep calm
  - 3. keep record
  - 4. keep control

**Q.12** Select the most appropriate option to fill in the blank.  
I am doubtful about his story, though you seem to be \_\_\_\_\_.

- Ans**
- 1. regretting
  - 2. uncertain
  - 3. pleasant
  - 4. convinced



Q.13 Select the most appropriate ANTONYM of the given word.  
Powerful

- Ans
- 1. Strong
  - 2. Impotent
  - 3. Manly
  - 4. Wild

Q.14 Select the most appropriate ANTONYM of the underlined word.  
The government is planning to abolish child care leave for female employees.

- Ans
- 1. Ensure
  - 2. Eradicate
  - 3. Encourage
  - 4. Establish

Q.15 Select the INCORRECTLY spelt word.

- Ans
- 1. Appraisal
  - 2. Definate
  - 3. Stretch
  - 4. Genuine

Q.16 Select the most appropriate synonym of the given word.  
Estimate

- Ans
- 1. Evaluate
  - 2. Appropriate
  - 3. Profit
  - 4. Verify

Q.17 Select the most appropriate option that can substitute the underlined segment in the given sentence.  
We shall rehearse thrice before the final performance at least we make errors in the dialogues.

- Ans
- 1. for we make errors
  - 2. but we make errors
  - 3. can we make errors
  - 4. lest we make errors

Q.18 Select the most appropriate ANTONYM for the underlined word in the given sentence.  
Because the politician made a candid speech, he earned the respect of the voters.

- Ans
- 1. Reticent
  - 2. Prudent
  - 3. Deceitful
  - 4. Reckless

Q.19 Select the correct spelling of the underlined word in the given sentence.  
She decided to file a complaint with HR after being harrasad by her supervisor for several weeks.

- Ans
- 1. harassed
  - 2. harrassd
  - 3. harrased
  - 4. harased

Q.20 Select the most appropriate option that can substitute the underlined word in the following sentence.  
They studied during three hours.

- Ans
- 1. by
  - 2. for
  - 3. at
  - 4. from

Q.21 Select the most appropriate option that can substitute the underlined words in the given sentence.  
This newly arisen evidence could have proved to finally put the culprit behind bars.

- Ans
- 1. is proof
  - 2. can proof
  - 3. can be proven
  - 4. could have been proven

Q.22 Select the most appropriate ANTONYM of the given word.

Innovate

- Ans
- 1. Solve
  - 2. Finance
  - 3. Invent
  - 4. Copy

Q.23 Select the most appropriate idiom to fill the blank in the given situation.

They were waiting for their family members who were returning from a pilgrimage. Therefore, they were \_\_\_\_\_ on the platform.

- Ans
- 1. running behind time
  - 2. playing a joke
  - 3. pacing up and down
  - 4. rolling up their sleeves

Q.24 Select the most appropriate synonym of the underlined word.

The removal of petty restrictions has made life easier.

- Ans
- 1. Big
  - 2. Consequential
  - 3. Large
  - 4. Small

Q.25 Select the most appropriate option that can substitute the underlined segment in the given sentence. If there is no need to substitute it, select 'No substitution required'.

If you give away smoking, your health will improve.

- Ans
- 1. No substitution required
  - 2. give up
  - 3. give off
  - 4. give out

Q.1 In a certain code language, 'cooler is hot' is written as 'tp rc dl' and 'hot weather comes' is written as 'rc dn nz'. How is 'hot' written in the given language?

- Ans
- 1. rc
  - 2. nz
  - 3. dn
  - 4. dl

Q.2 Choose the alternative which closely resembles the mirror image of the given combination.



- Ans
- 1. sKcIjFTEEn
  - 2. sKcIjFTEEn
  - 3. nETFLiCKs
  - 4. nETFLiCKs

Q.3 What will come in the place of the question mark (?) in the following equation, if '+' and '-' are interchanged and '×' and '÷' are interchanged?

$$204 \times 4 - 9 \div 2 + 6 = ?$$

- Ans
- 1. 64
  - 2. 63
  - 3. 61
  - 4. 62

Q.4 Select the set in which the numbers are related in the same way as are the numbers of the following sets. (NOTE: Operations should be performed on the whole numbers, without breaking down the numbers into its constituent digits. E.g., 13 - Operations on 13 such as adding/deleting/multiplying etc. to 13 can be performed. Breaking down 13 into 1 and 3 and then performing mathematical operations on 1 and 3 is not allowed.)  
(6, 12, 48)  
(8, 16, 64)

- Ans
- 1. (12, 28, 112)
  - 2. (14, 28, 110)
  - 3. (14, 24, 112)
  - 4. (14, 28, 112)

Q.5 If 'A' stands for '+', 'B' stands for '×', 'C' stands for '-' and 'D' stands for '÷', what will come in place of the question mark (?) in the following equation?

$$82 \text{ B } 6 \text{ D } 114 \text{ A } 2 \text{ C } 35 = ?$$

- Ans
- 1. 470
  - 2. 460
  - 3. 450
  - 4. 480

Q.6 If 20 March 2011 was Sunday, then what was the day of the week on 20 March 2019?

- Ans
- 1. Monday
  - 2. Wednesday
  - 3. Saturday
  - 4. Friday

Q.7 What should come in place of the question mark (?) in the given series?

13, 17, 26, ?, 67, 103, 152

- Ans
- 1. 59
  - 2. 47
  - 3. 33
  - 4. 42

Q.8 Select the correct mirror image of the given combination when the mirror is placed at MN as shown below.

M  
|  
M 2 a P v d  
|  
N

- Ans
- 1. b v d a P 2 M
  - 2. P v d a P 2 M
  - 3. b v P a S M
  - 4. P v d a S M

Q.9 What should come in place of the question mark (?) in the given series?

268, 259, 250, 241, 232, ?

- Ans
- 1. 221
  - 2. 224
  - 3. 223
  - 4. 220

Q.10 In a certain code language,  
'M & N' means 'M is the wife of N',  
'M @ N' means 'M is the brother of N',  
'M \$ N' means 'M is the daughter of N',  
'M # N' means 'M is the son of N'.  
Based on the above, how is Q related to N if 'N # M @ O \$ P & Q'?

- Ans
- 1. Brother
  - 2. Father
  - 3. Mother's father
  - 4. Father's father

Q.11 Select the word-pair that best represents a similar relationship to the one expressed in the pair of words given below.  
(The words must be considered as meaningful English words and must not be related to each other based on the number of letters/number of consonants/vowels in the word.)

Dawn – Sunrise

- Ans
- 1. Touch – Toes
  - 2. Joy – Sad
  - 3. Easy – Simple
  - 4. Old – New

Q.12 Three statements are followed by conclusions numbered I, II. You have to consider these statements to be true, even if they seem to be at variance with commonly known facts. Decide which of the given conclusions logically follows from the given statement.

Statements:

All water is earth.

All earth is fire.

Some fire is air.

Conclusion (I): Some air is earth.

Conclusion (II): Some fire is water.

- Ans
- 1. Both conclusions (I) and (II) follow.
  - 2. Only conclusion (II) follows.
  - 3. Only conclusion (I) follows.
  - 4. Neither conclusion (I) nor (II) follows.

Q.13 Three of the following four letter-clusters are alike in a certain way and thus form a group. Select the letter-cluster that does NOT belong to that group (Note: The odd one out is not based on the number of consonants/vowels or their position in the letter cluster)

- Ans
- 1. XBF
  - 2. QUY
  - 3. LHJ
  - 4. FJN

Q.14 Select the correct mirror image of the given combination when the mirror is placed at MN as shown below.

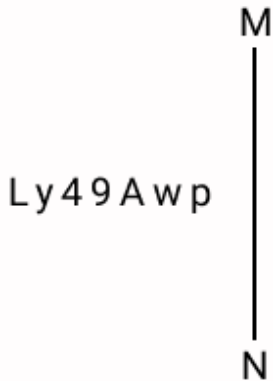

- Ans
- 1. d mA 9 4 p v J
  - 2. q w v 6 4 v L
  - 3. A w p 9 4 v J
  - 4. q w A 9 4 v J

Q.15 What should come in place of ? in the given series based on the English alphabetical order?

JMP UZE FMT QZI ?

- Ans
- 1. BMX
  - 2. LNP
  - 3. XHN
  - 4. SLP

Q.16 Six letters N, P, R, S, T and U are written on different faces of a dice. Two positions of this dice are shown in the figure. Which is the letter on the face opposite to the face containing U?

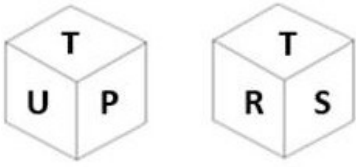

- Ans
- 1. P
  - 2. S
  - 3. N
  - 4. R

Q.17 How many rectangles are there in the given figure?

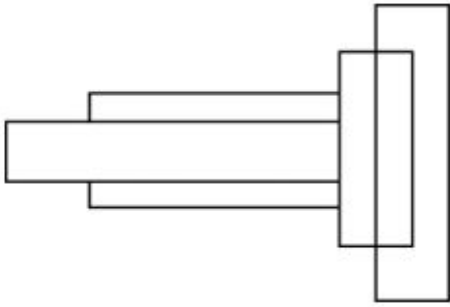

- Ans
- 1. 6
  - 2. 7
  - 3. 5
  - 4. 8

Adda247 Marathi

Q.18 A paper is folded and cut as shown below. How will it appear when unfolded?

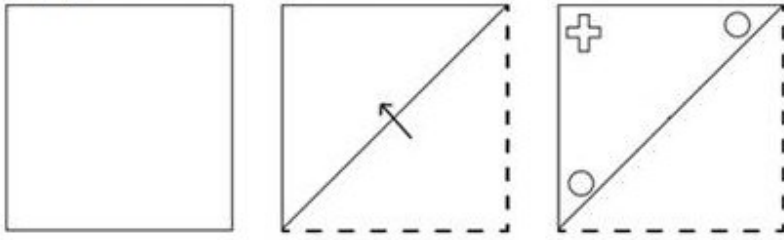

Ans

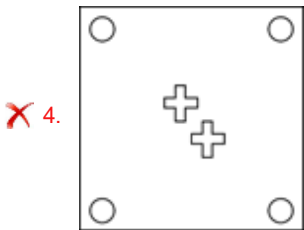
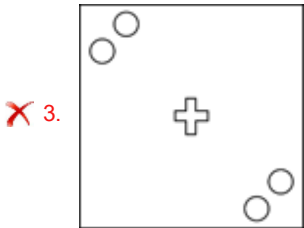
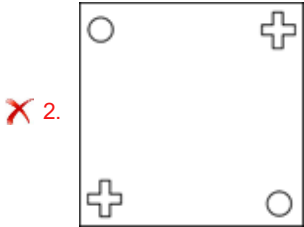
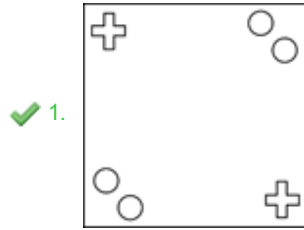

Q.19 In a certain code language, 'PBI' is coded as '27' and 'ZEBRA' is coded as '125'. What is the code for 'BIRD' in the given code language?

- Ans
- ✗ 1. 49
  - ✓ 2. 64
  - ✗ 3. 37
  - ✗ 4. 25

Q.20 Select the word-pair that best represents a similar relationship to the one expressed in the pair of words given below.

(The words must be considered as meaningful English words and must not be related to each other based on the number of letters/number of consonants/vowels in the word)

Strong : Robust

- Ans
- ✓ 1. Kind : Generous
  - ✗ 2. Knowledge : Ignorance
  - ✗ 3. Brave : Fearful
  - ✗ 4. Create : Destroy

Q.21 The position of how many letters will remain unchanged if each of the letters in the word DETAIL is arranged in the alphabetical order?

- Ans
- 1. None
  - 2. Three
  - 3. Two
  - 4. One

Q.22 Identify the figure given in the options that when put in place of the question mark (?) will logically complete the series.

I	B	I	X	
X ♡ B 7	X I ♡ B X 7	♡ B X 7	♡ I	?
7	♡	7	B	

Ans

1.

B
♡ I 7
X

2.

I
B X ♡
7

3.

B
I X 7
♡

4.

I
B 7 X
♡

Q.23 72 is related to 8 following a certain logic. Following the same logic, 198 is related to 22. To which of the following is 351 related following the same logic?  
 (NOTE : Operations should be performed on the whole numbers, without breaking down the numbers into its constituent digits. E.g. 13 – Operations on 13 such as adding /deleting /multiplying etc., to 13 can be performed. Breaking down 13 into 1 and 3 and then performing mathematical operations on 1 and 3 is not allowed.)

- Ans
- 1. 41
  - 2. 43
  - 3. 39
  - 4. 37



24. What will come in the place of '?' in the following equation if 'x' and '-' are interchanged and '+' and '÷' are interchanged?  
 $36 + 18 \times 9 \div 13 - 19 = ?$

- Ans
- 1. 234
  - 2. 246
  - 3. 280
  - 4. 240

25. Which of the following letter-clusters will replace the question mark (?) in the given series?

PAZ, REV, TIR, VOL, ?

- Ans
- 1. XUF
  - 2. XVG
  - 3. XVF
  - 4. XUE

Section : Quantitative Aptitude

Q.1 If  $f(p) = \sin^{p+2} x + \cos^{p+2} x$ , then the value of  $6f(2) - 4f(4) + 10f(0)$  is:

- Ans
- 1. 14
  - 2. 10
  - 3. 12
  - 4. 11

2. A policeman was asked to chase a thief. Before the policeman started the chase, he realised that the thief was 200 metres ahead of him and was running at a speed of 16 km/h. The policeman started the chase at a speed of 20 km/h. How far will the thief run before he is overtaken by the policeman?

- Ans
- 1. 1000 m
  - 2. 700 m
  - 3. 800 m
  - 4. 600 m

Q.3 A certain sum of money is lent out at simple interest. If that money becomes ₹24,000 in 2 years and ₹32,000 in 4 years, the annual rate of interest is:

- Ans
- 1. 30%
  - 2. 16%
  - 3. 25%
  - 4. 20%

Q.4 The volume of the hemisphere (to the nearest integer) with a radius of 5.5cm is (use  $\pi=3.14$ ):

- Ans
- 1. 378  $\text{cm}^3$
  - 2. 325  $\text{cm}^3$
  - 3. 348  $\text{cm}^3$
  - 4. 362  $\text{cm}^3$

Q.5 If  $x : y = 5 : 6$ , then  $2x + 3y : 3x + 5y$  is:

- Ans
- 1. 28 : 48
  - 2. 28 : 45
  - 3. 18 : 45
  - 4. 18 : 35

Q.6

The following table shows the production of food grains in a country over five years.

Year	Production (in ten lakh tonnes)			
	Wheat	Rice	Maize	Other grains
2016-17	650	250	200	450
2017-18	800	440	240	400
2018-19	680	390	220	500
2019-20	700	400	260	480
2020-21	640	440	300	520

What was the percentage increase in the production of rice in 2020-21 in comparison to the previous year?

- Ans
- 1. 10%
  - 2. 25%
  - 3. 20%
  - 4. 40%

Q.7

If  $A = \frac{9}{16} \div \frac{25}{36}$ ,  $B = 9 \div [(16 \div 25) \div 36]$ ,  $C = [9 \div (16 \div 25)] \div 36$ ,  $D = (9 \div 16) \div (25 \div 36)$ , then which of the following is true?

- Ans
- 1. B and D are equal.
  - 2. C and D are equal.
  - 3. A and B are equal.
  - 4. A and D are equal.

Q.8

If  $A = 60 \left[ \frac{6}{25} \div \left( \frac{16}{15} \text{ of } \frac{3}{8} \right) + 5 - \left( 1 - 2\frac{1}{12} \right) \right]$ , then the sum of the digits of A is:

- Ans
- 1. 7
  - 2. 3
  - 3. 5
  - 4. 6

Q.9

The ratio of the outer and the inner circumference of a circular path is 7:6. If the path is 45 m wide, then what is the radius (in m) of the inner circle?

- Ans
- 1. 240
  - 2. 120
  - 3. 150
  - 4. 270

Q.10

P and Q can do a work in 12 days and 9 days, respectively. They both worked together and earned ₹63,000. The share of P (in ₹) is:

- Ans
- 1. 21,000
  - 2. 36,000
  - 3. 9,000
  - 4. 27,000

Q.11 After an increase of 9% in salary, a person received ₹6,300. What was his salary before the increase (consider integral part only)?

- Ans
- 1. ₹3,879
  - 2. ₹5,779
  - 3. ₹5,000
  - 4. ₹4,000

Q.12 A vendor buys 20 dozen bananas for ₹1,200 and sells 5 dozen for ₹350, then his gain percentage is:

- Ans
- 1.  $15\frac{1}{3}\%$
  - 2.  $13\frac{2}{3}\%$
  - 3.  $21\frac{1}{3}\%$
  - 4.  $16\frac{2}{3}\%$

Q.13 In an isosceles triangle ABC, AB=AC. D is a point inside the triangle such that  $\angle BAD = 20^\circ = \angle DCB$ ,  $\angle CAD = 80^\circ$ . The value of  $\angle ABC$  is:

- Ans
- 1.  $25^\circ$
  - 2.  $15^\circ$
  - 3.  $20^\circ$
  - 4.  $40^\circ$

Q.14 Study the given graph and answer the question that follows.

The graph shows the profit percentage earned by two companies – A and B over a period of six years.

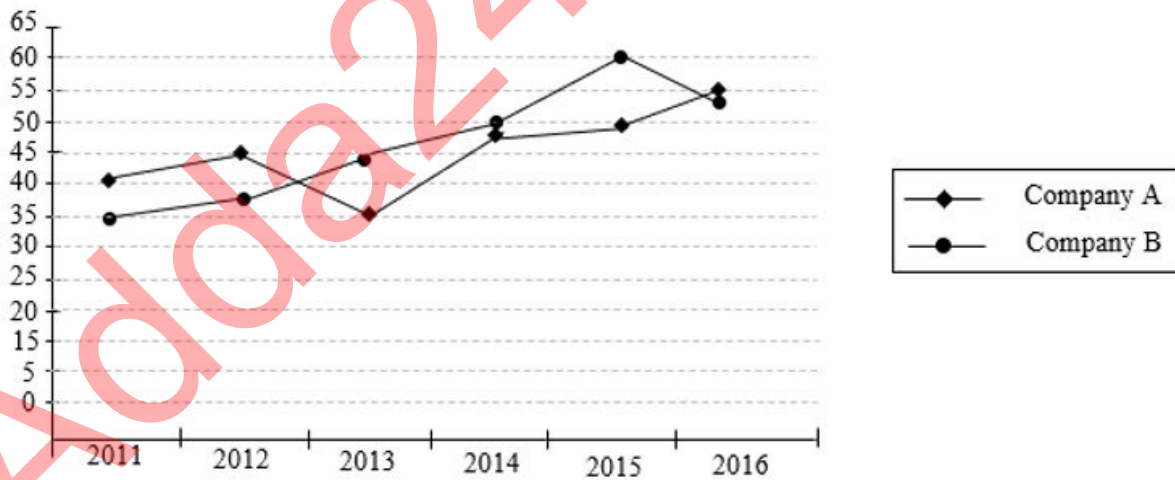

If the income of the company A in the year 2012 was ₹6.425 lakh, what was its expenditure in that year?

- Ans
- 1. ₹4.43 lakh
  - 2. ₹4.7 lakh
  - 3. ₹4.5 lakh
  - 4. ₹5.2 lakh

Q.15 A line from point A is drawn that is tangent to the circle at point B. A secant is also drawn from point A to the circle intersecting it at points C and D. If  $AB = 42$  cm and  $AC = 21$  cm, then what is the ratio between AB and CD?

- Ans
- 1. 2 : 3
  - 2. 2 : 5
  - 3. 3 : 2
  - 4. 3 : 4

Q.16 A cube of edge 4 cm is cut into cubes each of edge of 2 cm. The ratio of the total surface area of one of the small cubes to that of the large cube is equal to:

- Ans
- 1. 1 : 64
  - 2. 1 : 16
  - 3. 1 : 4
  - 4. 1 : 8

Q.17 The following pie chart gives the distribution of constituents in the human body.

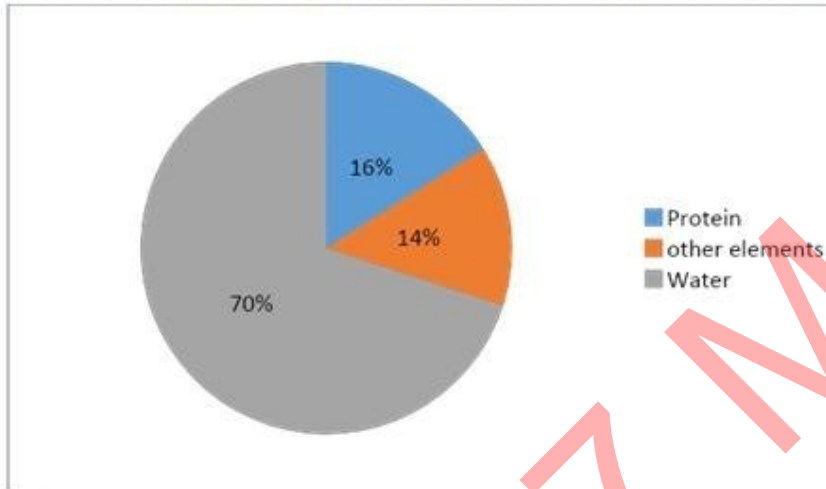

What is the central angle of the sector showing the distribution of protein and other constituents?

- Ans
- 1.  $108^\circ$
  - 2.  $34^\circ$
  - 3.  $120^\circ$
  - 4.  $45^\circ$

Q.18 Shopkeeper A marks up his price for an item at 25% and offers a discount of 15%. The same item is marked at 20% by another shopkeeper B and sold at a discount of 12%. Who gets a better deal in terms of % profit and by what profit percentage he sells that item?

- Ans
- 1. B by 5.6%
  - 2. B by 0.65%
  - 3. A by 0.55%
  - 4. A by 6.25%

Q.19 When 12 is subtracted from a number, it reduces to its 40%. Two-fifth of that number is:

- Ans
- 1. 20
  - 2. 12
  - 3. 8
  - 4. 50

Q.20 The length (in cm) of a direct common tangent to two circles of radii 14 cm and 5 cm whose centres are separated by a distance of 40 cm is:

- Ans
- 1. 40 cm
  - 2. 41 cm
  - 3.  $\sqrt{1539}$  cm
  - 4.  $\sqrt{1519}$  cm

Q.21 The given pie chart shows the total number of passengers (in percentage) travelling from Ahmedabad junction to various districts. Study the pie chart and answer the question that follows.

Total number of passengers travelling from Ahmedabad junction to various districts = 8,000

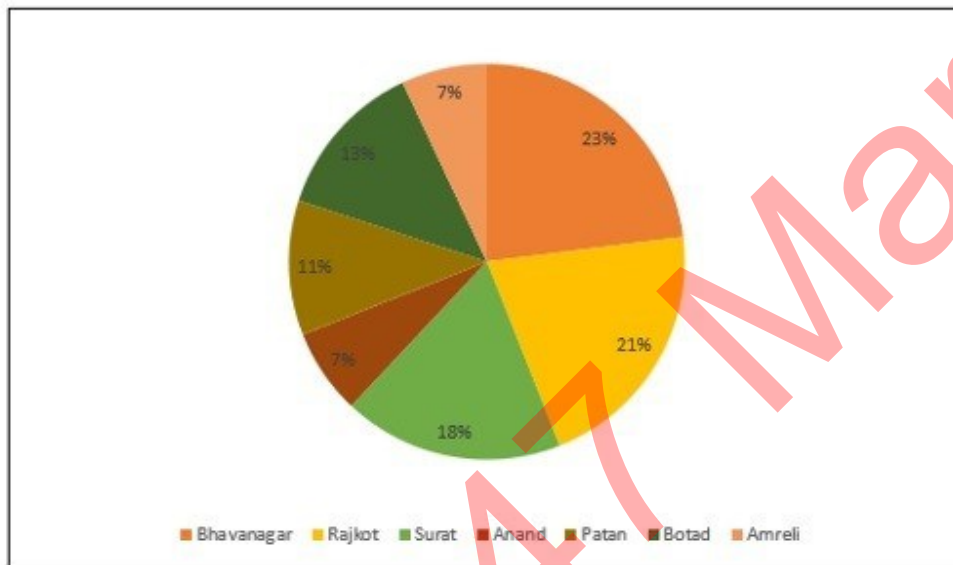

What is the average number of passengers travelling from Ahmedabad to Surat, Botad and Bhavanagar together?

- Ans
- 1. 1510
  - 2. 1360
  - 3. 1220
  - 4. 1440

Q.22 The curved surface area of a right circular cone is  $20\pi$  cm<sup>2</sup>. If its radius is 4 cm, then find the volume of cone.

- Ans
- 1.  $18\pi$  cm<sup>3</sup>
  - 2.  $21\pi$  cm<sup>3</sup>
  - 3.  $20\pi$  cm<sup>3</sup>
  - 4.  $16\pi$  cm<sup>3</sup>

Q.23 In an election there were three candidates. The first candidate got 40% votes and second candidate got 35% votes. If the total votes in the election are 50,000, find the number of votes got by the third candidate.

- Ans
- 1. 12000
  - 2. 1250
  - 3. 12500
  - 4. 13,500

Q.24

P got married 15 years ago. Today her age is  $1\frac{3}{5}$  times her age at the time of her marriage. At present her son's age is  $\frac{1}{5}$  of her age. What was her son's age 4 years ago as a fraction of P's age at that time?

Ans

1.  $\frac{1}{9}$

2.  $\frac{1}{8}$

3.  $\frac{5}{9}$

4.  $\frac{1}{10}$

Q.25 Ratna buys 10 kg of rice for ₹88 per kg and another 20 kg of rice for ₹187 per kg. What is the per kg cost (in ₹) of the total mixture of rice for her?

Ans

1. 148

2. 150

3. 158

4. 154

Section : General Awareness

1. Which was the first socio-religious organisation established in Bombay in 1840 to work for the annihilation of caste?

Ans  1. Satyashodhak Samaj

2. Vishwa Jain Sangathan

3. Paramhans Mandali

4. Dharma Sabha

2. Which of the following is NOT applicable to force?

Ans  1. Force may change the shape of an object

2. Force may change the direction of a moving object

3. Force may increase the mass of the object

4. Force may make an object move

3. In the year 2021, the Department of Public Enterprises has now been made part of the \_\_\_\_\_ Ministry, to speed up the privatisation process and exercise greater financial control over the state-run-enterprises.

Ans  1. Micro, Small and Medium Enterprises

2. Heavy Industries and Public Enterprises

3. Finance

4. Commerce and Industry

Q.4 Competitive behaviour and competitive market structure are \_\_\_\_\_ related.

Ans  1. not

2. directly

3. inversely

4. proportionately

Q.5 How many basic talams are there in Indian Classical Carnatic music?

- Ans
- 1. 37
  - 2. 7
  - 3. 21
  - 4. 11

Q.6 Which of the following is NOT a condition for acquiring the citizenship of India?

- Ans
- 1. Holding property
  - 2. Descent
  - 3. Registration
  - 4. Domicile

Q.7 The catchphrase of which census is 'Our census, our future'?

- Ans
- 1. 1981
  - 2. 2001
  - 3. 1991
  - 4. 2011

Q.8 The Gulf of Khambhat, the Gulf of Kutch and Gangetic delta provide ideal conditions for utilising \_\_\_\_\_ energy.

- Ans
- 1. solar
  - 2. atomic
  - 3. geo thermal
  - 4. tidal

Q.9 How many times has India hosted the ICC Men's T-20 Cricket World Cup as of 2023?

- Ans
- 1. 3
  - 2. 4
  - 3. 2
  - 4. 1

Q.10 'Reservation in promotion' comes under which Article of the Constitution?

- Ans
- 1. Article 15 (3B)
  - 2. Article 19 (2)
  - 3. Article 14 (4A)
  - 4. Article 16 (4A)

Q.11 Who took oath as the Chief Minister of Karnataka, in May 2023?

- Ans
- 1. Siddaramaiah
  - 2. Mallikarjun Kharge
  - 3. MK Stalin
  - 4. DK Sivakumar

Q.12

Match the items in List I with those in List II.

**List I**

**List II**

i. Balanced Growth Theory

a. Rosenstein Rodan

ii. Big Push Theory

b. Feldman-Mahalanobis

iii. Secular Deterioration

c. Ragnar Nurkse

iv. Capital Goods and Heavy Industry

d. Prebisch-Singer

Ans

- 1. i-c, ii-d, iii-a, iv-b
- 2. i-d, ii-a, iii-b, iv-c
- 3. i-c, ii-a, iii-d, iv-b
- 4. i-a, ii-b, iii-d, iv-c

Q.13 As of 2022, which among of the following is the leading tidal energy generation site of India?

Ans

- 1. Sunderbans
- 2. Seashore of Maharashtra
- 3. Gulf of Kutch
- 4. Gulf of Mannar

Q.14 Which of the following is an example of multi-factor authentication for PC security?

Ans

- 1. Antivirus software
- 2. Fingerprint scan
- 3. OS protection
- 4. Firewall protection

Q.15 Which of the following is a feature of Directive Principles of State Policy, and also distinguishes it from Fundamental Rights?

Ans

- 1. It protects the interest of the individual.
- 2. It is prohibitive in nature.
- 3. It is non-justiciable.
- 4. It is justiciable.

Q.16 Which planet is the second largest planet in our solar system and also has the biggest and brightest rings around it? Ans

- 1. Saturn
- 2. Earth
- 3. Uranus
- 4. Jupiter

Q.17 Which of the following muscles regulates the exit of food from the stomach into the small intestine?

Ans

- 1. Gastrocnemius
- 2. Pectoralis
- 3. Rectus
- 4. Sphincter



Q.18 Which of the following awards is presented for lifetime achievement in sports and games? It was instituted to honour those sportspersons who have contributed to sports by their performance and continue to contribute to the promotion of sports even after their retirement from an active sporting career.

- Ans
- 1. Arjuna Award
  - 2. Dhyanchand Award
  - 3. Dronacharya Award
  - 4. Major Dhyan Chand Khel Ratna

Q.19 What function does the public key serve in digital signature verification?

- Ans
- 1. To ensure confidentiality during transmission
  - 2. To encrypt the digital signature
  - 3. To decrypt the digital signature
  - 4. To calculate the hash value of the message or file content

Q.20 Which of the following is the official language of Afghanistan?

- Ans
- 1. Uzbek
  - 2. Dhivehi
  - 3. Dari
  - 4. Turkmen

Q.21 Bharatanatyam dance form is associated with:

- Ans
- 1. Karnataka
  - 2. Tamil Nadu
  - 3. Himachal Pradesh
  - 4. Haryana

Q.22 With which Gharana is the famous Tarana singer, Pandit Rattan Mohan Sharma associated?

- Ans
- 1. Talwandi Gharana
  - 2. Patiala Gharana
  - 3. Agra Gharana
  - 4. Mewati Gharana

Q.23 What is the minimum number of football players required in a team for a match to start?

- Ans
- 1. 11
  - 2. 8
  - 3. 10
  - 4. 7

Q.24 The founder of the Pala empire was:

- Ans
- 1. Rayala
  - 2. Gopala
  - 3. Devapala
  - 4. Dharmapala

Q.25 'Tamu Lochar' is one of the traditional festivals of the \_\_\_\_\_ of Sikkim. It is celebrated to mark the beginning of their new year, which falls on the 15th day of Pusa, according to the Hindu calendar Vikram Samvat and 30th December in the English calendar.

- Ans
- 1. Mangar community
  - 2. Bhutia community
  - 3. Lepcha community
  - 4. Gurung community

Adda247 Marathi

## Combined Higher Secondary Level Examination 2024 Tier I

Exam Date	10/07/2024
Exam Time	2:30 PM - 3:30 PM
Subject	CHSL Exam 2024 Tier I

### Section : English Language

1. The following sentence has been split into four segments. Identify the segment that contains a grammatical error. I used to eat into / in the evening / when my parents / were on night shifts.

- Ans
- 1. I used to eat into
  - 2. when my parents
  - 3. in the evening
  - 4. were on night shifts

Q.2 The following sentence has been split into four segments. Identify the segment that contains a grammatical error. (1) Ganga was (2) out shopping at the mall (3) and ran over (4) her schoolmate.

- Ans
- 1. 4
  - 2. 1
  - 3. 2
  - 4. 3

3. The following sentence has been split into four segments. Identify the segment that contains an error. Shall have / you bring / your note-book / tomorrow?

- Ans
- 1. Shall have
  - 2. you bring
  - 3. tomorrow
  - 4. your note-book

Q.4 Select the option with the correct use of future tense.

- Ans
- 1. If you worked hard in the same manner, you will soon achieve success.
  - 2. If you had work hard in the same manner, you will soon achieve success.
  - 3. If you have work hard in the same manner, you will soon achieve success.
  - 4. If you work hard in the same manner, you will soon achieve success.

### Comprehension:

In the following passage, some words have been left out. Select the most appropriate option to fill in each blank.

In today's fast-paced and technology-driven world, (1) \_\_\_\_\_ is crucial to disconnect occasionally for the sake of our health. (2) \_\_\_\_\_ exposure to screens and the demands of the digital era can lead to stress, anxiety and reduced well-being. Taking time to unplug and engage (3) \_\_\_\_\_ activities that promote relaxation, such as spending time in nature, (4) \_\_\_\_\_ hobbies or simply enjoying quality time with loved ones allows us to recharge, find balance and (5) \_\_\_\_\_ our mental and physical health.

### SubQuestion No : 5

Q.5 Select the most appropriate option to fill in blank no. 1.

- Ans
- 1. that
  - 2. this
  - 3. these
  - 4. it

**Comprehension:**

In the following passage, some words have been left out. Select the most appropriate option to fill in each blank.

In today's fast-paced and technology-driven world, (1) \_\_\_\_\_ is crucial to disconnect occasionally for the sake of our health. (2) \_\_\_\_\_ exposure to screens and the demands of the digital era can lead to stress, anxiety and reduced well-being. Taking time to unplug and engage (3) \_\_\_\_\_ activities that promote relaxation, such as spending time in nature, (4) \_\_\_\_\_ hobbies or simply enjoying quality time with loved ones allows us to recharge, find balance and (5) \_\_\_\_\_ our mental and physical health.

**SubQuestion No : 6**

**Q.6** Select the most appropriate option to fill in blank no. 2.

- Ans**
- 1. Interrupted
  - 2. Sporadic
  - 3. Constant
  - 4. Redundant

**Comprehension:**

In the following passage, some words have been left out. Select the most appropriate option to fill in each blank.

In today's fast-paced and technology-driven world, (1) \_\_\_\_\_ is crucial to disconnect occasionally for the sake of our health. (2) \_\_\_\_\_ exposure to screens and the demands of the digital era can lead to stress, anxiety and reduced well-being. Taking time to unplug and engage (3) \_\_\_\_\_ activities that promote relaxation, such as spending time in nature, (4) \_\_\_\_\_ hobbies or simply enjoying quality time with loved ones allows us to recharge, find balance and (5) \_\_\_\_\_ our mental and physical health.

**SubQuestion No : 7**

**Q.7** Select the most appropriate option to fill in blank no. 3.

- Ans**
- 1. in
  - 2. into
  - 3. to
  - 4. for

**Comprehension:**

In the following passage, some words have been left out. Select the most appropriate option to fill in each blank.

In today's fast-paced and technology-driven world, (1) \_\_\_\_\_ is crucial to disconnect occasionally for the sake of our health. (2) \_\_\_\_\_ exposure to screens and the demands of the digital era can lead to stress, anxiety and reduced well-being. Taking time to unplug and engage (3) \_\_\_\_\_ activities that promote relaxation, such as spending time in nature, (4) \_\_\_\_\_ hobbies or simply enjoying quality time with loved ones allows us to recharge, find balance and (5) \_\_\_\_\_ our mental and physical health.

**SubQuestion No : 8**

**Q.8** Select the most appropriate option to fill in blank no. 4.

- Ans**
- 1. constructing
  - 2. pursuing
  - 3. chasing
  - 4. trailing

**Comprehension:**

In the following passage, some words have been left out. Select the most appropriate option to fill in each blank.

In today's fast-paced and technology-driven world, (1) \_\_\_\_\_ is crucial to disconnect occasionally for the sake of our health. (2) \_\_\_\_\_ exposure to screens and the demands of the digital era can lead to stress, anxiety and reduced well-being. Taking time to unplug and engage (3) \_\_\_\_\_ activities that promote relaxation, such as spending time in nature, (4) \_\_\_\_\_ hobbies or simply enjoying quality time with loved ones allows us to recharge, find balance and (5) \_\_\_\_\_ our mental and physical health.

**SubQuestion No : 9**

**Q.9** Select the most appropriate option to fill in blank no. 5.

- Ans**
- 1. precede
  - 2. focus
  - 3. prioritise
  - 4. underscore

Q.10 Select the most appropriate option to fill in the blank.  
I don't like dirty cars, so you should keep it \_\_\_\_\_.

- Ans
- 1. shabby
  - 2. similar
  - 3. new
  - 4. spotless

Q.11 Select the most appropriate idiom to complete the given sentence.  
With the increasing market prices and stagnant salaries, he is \_\_\_\_\_.

- Ans
- 1. taking a break
  - 2. feeling the pinch
  - 3. beating the rap
  - 4. getting it off his chest

Q.12 Select the most appropriate ANTONYM of the given word.

Stoic

- Ans
- 1. Tolerant
  - 2. Apathetic
  - 3. Fervent
  - 4. Cooperative

Q.13 Select the most appropriate ANTONYM of the underlined word in the given sentence.  
The stone was also said to have occult powers.

- Ans
- 1. latent
  - 2. intelligible
  - 3. ambiguous
  - 4. unfathomable

Q.14 Select the INCORRECTLY spelt word.

- Ans
- 1. Connoisseur
  - 2. Circumlocution
  - 3. Haphazard
  - 4. Disintigrate

Q.15 Read the given sentence carefully. Change the meaning of the sentence by replacing the underlined word with its ANTONYM from the following options.

His father warned him not to use vulgar language at home.

- Ans
- 1. decorous
  - 2. ribald
  - 3. impervious
  - 4. licentious

Q.16 Select the option that will improve the underlined part of the given sentence.

She's under the allusion that she'll get the job.

- Ans
- 1. illusion
  - 2. hallucination
  - 3. vision
  - 4. unreality

Q.17 Select the most appropriate option that can substitute the underlined segment in the given sentence.  
The common masses have waited for three hours to meet the king in the royal court.

- Ans
- 1. has been waiting
  - 2. had waiting
  - 3. have been waiting
  - 4. will waiting

Q.18 Complete the given sentence with an appropriate homophone from the given options.  
There was no one \_\_\_\_\_ a few of my friends.

- Ans
- 1. except
  - 2. expect
  - 3. accept
  - 4. excerpt

Q.19 Choose an appropriate word that can substitute the bracketed word and complete the sentence meaningfully.  
Shelley was very happy (while) I accepted her invitation to her birthday party.

- Ans
- 1. when
  - 2. as
  - 3. after
  - 4. before

Q.20 There is a spelling error in the given sentence. Select the option that contains the INCORRECTLY spelt word.  
The choice of buying a yahct was poor.

- Ans
- 1. buying
  - 2. yahct
  - 3. choice
  - 4. poor

Q.21 Select the most appropriate synonym of the given word.

Absurd

- Ans
- 1. Sudden
  - 2. Arbitrary
  - 3. Irrational
  - 4. Abstruse

Q.22 Select the most appropriate option to substitute the underlined segment in the following sentence.  
There was some drawing-pins in my desk.

- Ans
- 1. There is some
  - 2. There has some
  - 3. Theirs some
  - 4. There are some

Q.23 Select the most appropriate ANTONYM of the given word.  
Calm

- Ans
- 1. Urban
  - 2. Impressed
  - 3. Quiet
  - 4. Upset

Q.24 Select the most appropriate option to substitute the underlined part of the given sentence.  
Mr. Sengupta's complaint to the higher authority was only a red herring.

- Ans
- 1. candid confession
  - 2. fortunate evidence
  - 3. clever bluff
  - 4. discouraging act

Q.25 Select the most appropriate word to fill in the blank.

He has \_\_\_\_\_ vision because of his illness.

- Ans
- 1. blurred
  - 2. unfocused
  - 3. obscured
  - 4. faded

Section : General Intelligence

Q.1 If 'A' stands for '÷', 'B' stands for '-', 'C' stands for '×' and 'D' stands for '+', what will come in place of the question mark (?) in the following equation?

$$36 B 8 A 56 C 49 D 53 = ?$$

- Ans
- 1. 53
  - 2. 82
  - 3. 46
  - 4. 30

2. The position of how many letters will change if each of the letters in the word SKYLINE is arranged in alphabetical order?

- Ans
- 1. Seven
  - 2. Six
  - 3. Five
  - 4. Four

Q.3 'RENT' is related to 'IVMG' in a certain way based on the English alphabetical order. In the same way, 'PAYABLE' is related to 'KZBZYOV'. To which of the following is 'BARGUANDY' related, following the same logic?

- Ans
- 1. YZITFAMWB
  - 2. YZITVZMWB
  - 3. YZITFZMWB
  - 4. YZITFZMYB

Q.4 How many triangles are there in the given figure?

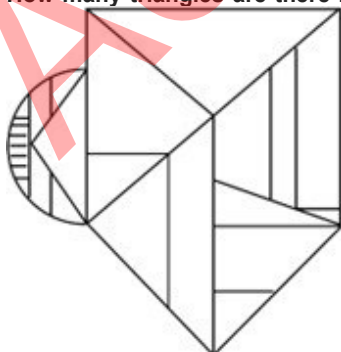

- Ans
- 1. 13
  - 2. 11
  - 3. 10
  - 4. 12

Q.5 What will come in the place of '?' in the following equation, if '×' and '÷' are interchanged?

$$45 \times 9 + 23 - 16 \div 7 = ?$$

- Ans
- 1. -84
  - 2. -79
  - 3. -64
  - 4. -76

Q.6 15 is related to 195 following a certain logic. Following the same logic, 19 is related to 247. To which of the following is related 24 following the same logic?  
(NOTE : Operations should be performed on the whole numbers, without breaking down the numbers into its constituent digits. E.g. 13 – Operations on 13 such as adding /deleting /multiplying etc., to 13 can be performed. Breaking down 13 into 1 and 3 and then performing mathematical operations on 1 and 3 is not allowed.)

- Ans
- 1. 322
  - 2. 332
  - 3. 300
  - 4. 312

Q.7 What should come in place of the question mark (?) in the given series?  
160, 187, 216, 247, ?

- Ans
- 1. 290
  - 2. 280
  - 3. 209
  - 4. 208

Q.8 In a certain code language,

'A+ B' means 'A is the son of B',  
'A - B' means 'A is the brother of B',  
'A × B' means 'A is the wife of B',  
'A ÷ B' means 'A is the daughter of B'.

Based on the above, how is L related to M if 'L - N ÷ O × M +P'?

- Ans
- 1. Father's father
  - 2. Brother
  - 3. Son
  - 4. Father

Q.9 In a certain code language, 'my best friend' is written as 'ck rl mk' and 'friend is life' is written as 'rt mp ck'. How is 'friend' written in the given language?

- Ans
- 1. rt
  - 2. ck
  - 3. rl
  - 4. mk



Q.10 Select the option figure in which the given figure (X) is embedded as its part (rotation is NOT allowed).

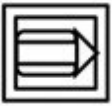

(X)

Ans

✓ 1.



✗ 2.

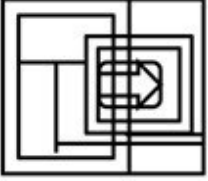

✗ 3.

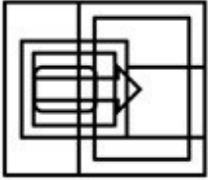

✗ 4.

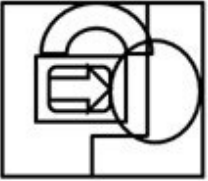

Adda247 Marathi

Q.11 A paper is folded and cut as shown below. How will it appear when unfolded?

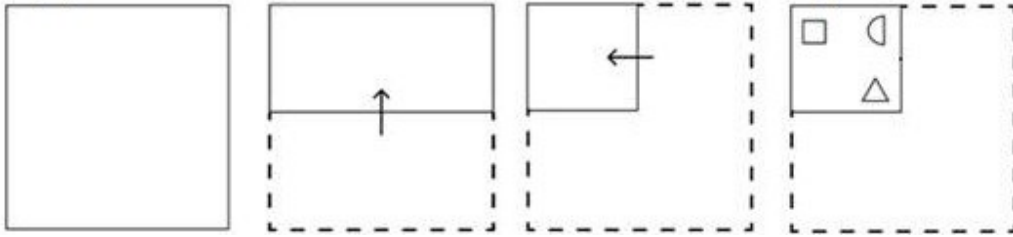

Ans

✗ 1.

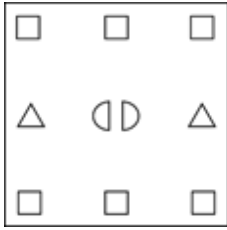

✗ 2.

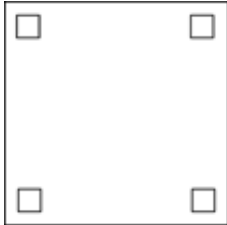

✓ 3.

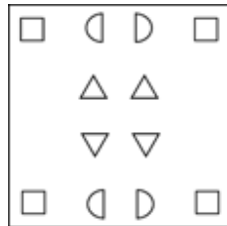

✗ 4.

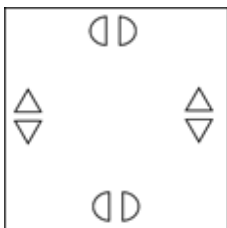

Adda247 Marathi

Q.12 Identify the figure in the options that when put in place of the question mark (?) will logically complete the series?

@ # +	@ @ # # + +	@ @ @ # # # + + +	@ @ @ @ # # # # + + + +	?
-------	-------------	-------------------	-------------------------	---

Ans

1.



2.

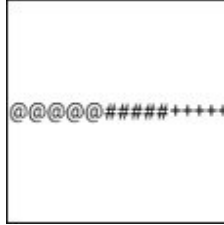

3.



4.

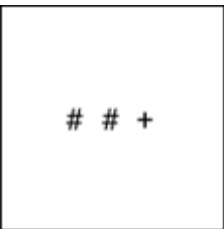

Q.13 What should come in place of the question mark (?) in the given series?

23, 44, 65, 86, ?, 128

Ans

1. 103

2. 109

3. 107

4. 105

Q.14 The position of how many letters will remain unchanged if each of the letters in the word COMPLEXITY is arranged from left to right in alphabetical order?

Ans

1. One

2. Two

3. None

4. Three

Q.15 Read the given statements and conclusions carefully. Assuming that the information given in the statements is true, even if it appears to be at variance with commonly known facts, decide which of the given conclusions logically follow(s) from the statements.

Statements:

Some laptops are computers.

No computer is a robot.

Some robots are humans.

Conclusions:

(I) All humans can never be computers.

(II) Some robots are laptops

- Ans
- 1. Only conclusion II follows
  - 2. Only conclusion I follows
  - 3. Both conclusions I and II follow
  - 4. None of the conclusions follow

Q.16 What should come in place of the question mark (?) in the given series based on the English alphabetical order?

BRK, XUH, TXE, PAB, ?

- Ans
- 1. NCX
  - 2. MDX
  - 3. LDY
  - 4. MCZ

Q.17 Select the word-pair that best represents a similar relationship to the one expressed in the pair of words given below.

(The words must be considered as meaningful English words and must not be related to each other based on the number of letters/number of consonants/vowels in the word)

Conquer : Surrender

- Ans
- 1. Lively : Vibrant
  - 2. Rich : Affluent
  - 3. Unite : Divide
  - 4. Gentle : Mild

Q.18 'A - B' means 'A is B's wife'.

'A + B' means 'A is B's brother'.

'A × B' means 'A is B's father'.

'A ÷ B' means 'A is B's sister'.

Using the same meaning of the mathematical operators as given above, in 'T × X ÷ Y + Z' what is T of Z's ?

- Ans
- 1. Brother
  - 2. Son
  - 3. Mother
  - 4. Father

Q.19 What should come in place of ? in the given series based on the English alphabetical order?

VOH YPN BQT ? HSF

- Ans
- 1. MOJ
  - 2. ERZ
  - 3. AXY
  - 4. JHI

**Q.20** Select the set in which the numbers are related in the same way as are the numbers of the following sets.  
(NOTE : Operations should be performed on the whole numbers, without breaking down the numbers into its constituent digits. E.g. 13 – Operations on 13 such as adding/deleting/multiplying etc. to 13 can be performed. Breaking down 13 into 1 and 3 and then performing mathematical operations on 1 and 3 is not allowed.)  
(84, 28, 7)  
(144, 48, 12)

- Ans**
- 1. (180, 50, 15)
  - 2. (180, 60, 10)
  - 3. (180, 60, 15)
  - 4. (160, 60, 15)

**Q.21** What will come in the place of the question mark (?) in the following equation, if '+' and '-' are interchanged and '×' and '÷' are interchanged?

$$5 - 63 + 9 + 10 \times 6 = ?$$

- Ans**
- 1. 39
  - 2. 33
  - 3. 36
  - 4. 30

Adda247 Marathi

Q.22 Select the option in which the given figure is embedded (rotation is NOT allowed).



Ans

✗ 1.

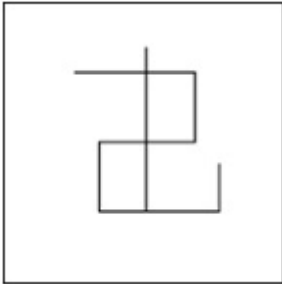

✗ 2.

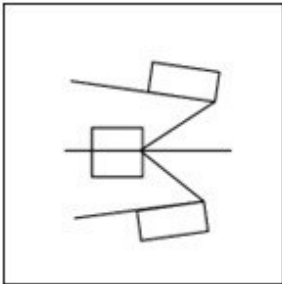

✓ 3.

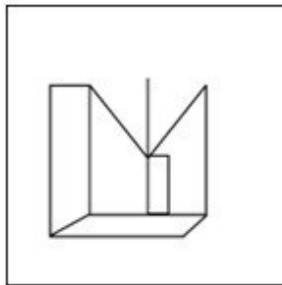

✗ 4.

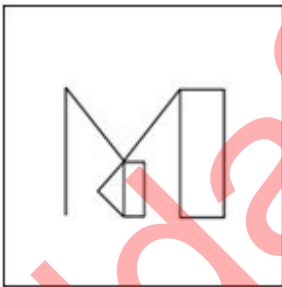

Q.23 Which of the following numbers will replace the question mark (?) in the given series?  
165 192 227 270 321 ?

Ans ✗ 1. 347

✗ 2. 361

✓ 3. 380

✗ 4. 392

Q.24 What would be the Roman numeral on the opposite side of 'VI' if the given sheet is folded to form a cube?

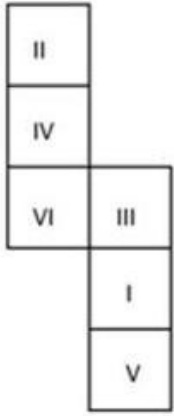

- Ans
- 1. V
  - 2. III
  - 3. I
  - 4. II

Q.25 Select the option figure in which the given figure is embedded as its part (rotation is NOT allowed).

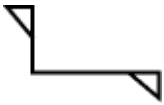

Ans

1.

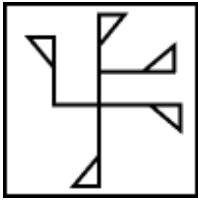

2.

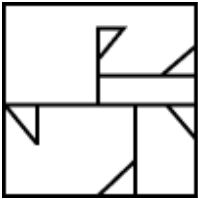

3.

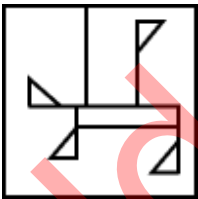

4.

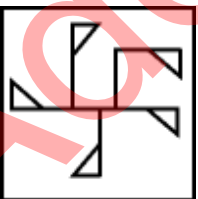

Q.1

A student has 5 subjects in an examination. The distribution of hard work of 16 hours a day over 5 subjects and marks obtained 400 out of 500 are shown in the charts.

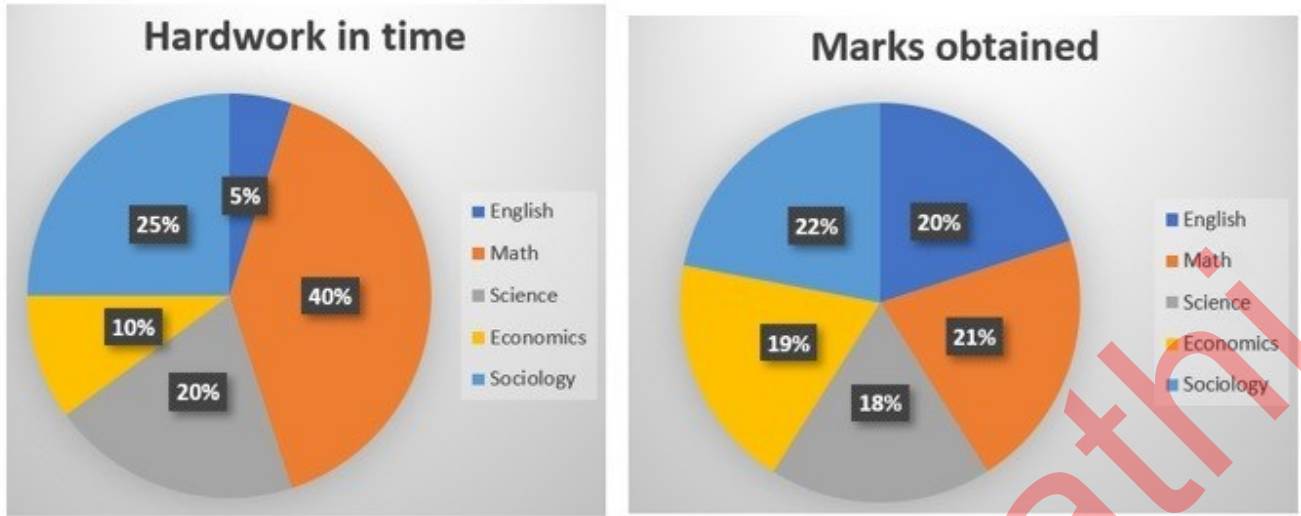

In which subject did the student get the highest outcome of the hard work (ratio of marks to hard work is highest)?

Ans

- ✓ 1. English
- ✗ 2. Math
- ✗ 3. Economics
- ✗ 4. Science



Q.2

The bar graph given below shows the sales of books (in thousands) from five branches of a publishing company during two consecutive years 2015 and 2016.

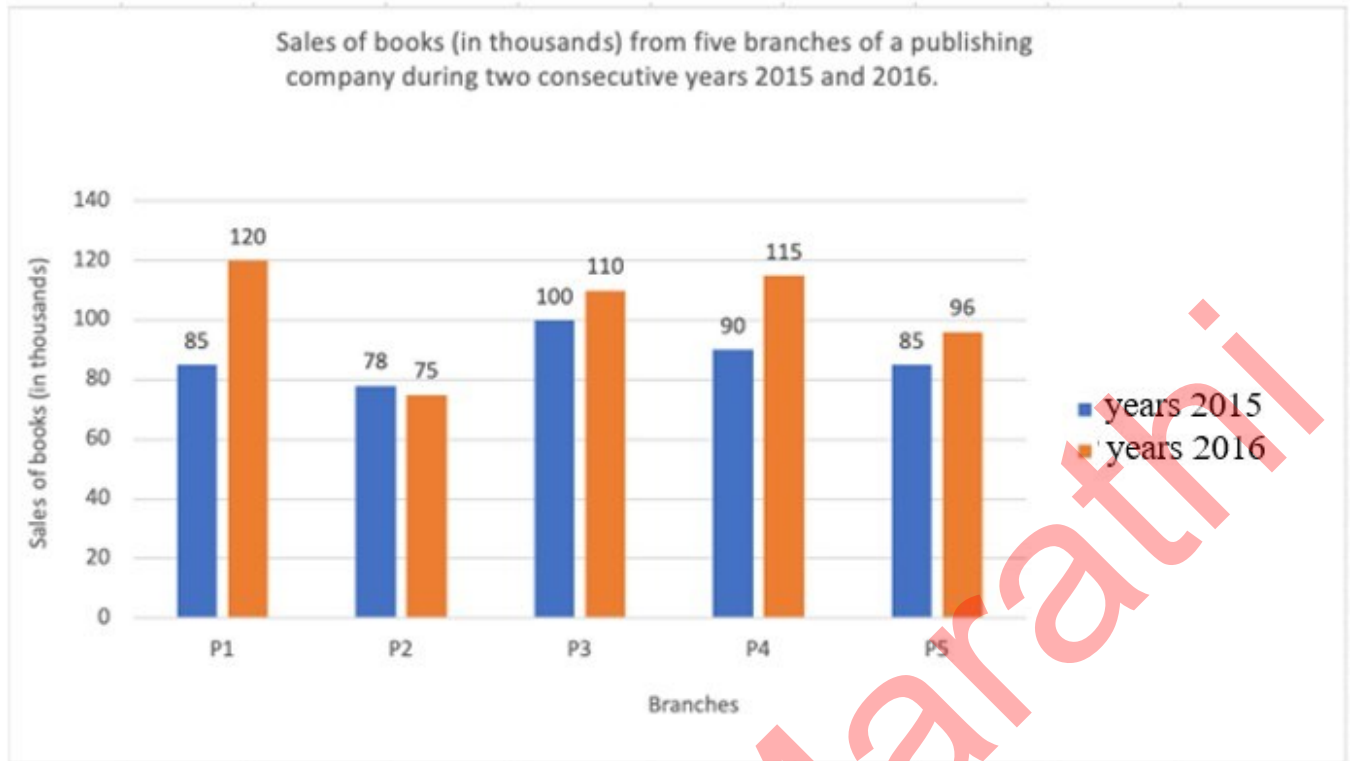

What percentage (rounded off to 2 decimal places) of the average sales of branches P1, P3 and P5 in 2016 is the average sales of branches P1, P2, P3 and P4 in 2015?

- Ans
- 1. 88.15%
  - 2. 76.53%
  - 3. 81.21%
  - 4. 80.12%

Q.3 The value of  $[3^3\{(40 \times 5) + (7 \times 6)\} \div 11] + (2^3 \times 15 \div 24)$  is:

- Ans
- 1. 959
  - 2. 595
  - 3. 599
  - 4. 559

Q.4 A cuboid with dimensions 20cm, 12cm, and 10 cm is cut into 8 identical pieces by 3 cuts. What will be the total surface area of all the pieces?

- Ans
- 1.  $1680 \text{ cm}^2$
  - 2.  $3360 \text{ cm}^2$
  - 3.  $2240 \text{ cm}^2$
  - 4.  $1220 \text{ cm}^2$

Q.5 An article is of size  $9 \text{ cm} \times 6 \text{ cm} \times 3 \text{ cm}$ . The number of such articles that can be packed in a box measuring  $63 \text{ cm} \times 42 \text{ cm} \times 21 \text{ cm}$  is:

- Ans
- 1. 343
  - 2. 243
  - 3. 49
  - 4. 196

Q.6 Reena and Riya together can complete a piece of work in 36 days. Riya and Geeta together can complete it in 54 days. Reena and Geeta together can complete it in 81 days. In how many days can Reena alone complete the work?

- Ans
- 1.  $82\frac{4}{7}$  days
  - 2.  $87\frac{4}{7}$  days
  - 3.  $97\frac{4}{7}$  days
  - 4.  $92\frac{4}{7}$  days

Q.7 Which of the following ratios is greater?

- Ans
- 1. 7 : 4
  - 2. 2 : 3
  - 3. 8 : 3
  - 4. 1 : 5

Q.8 Let ABCD be a quadrilateral and AC, BD be diagonals. The length of BD = 20 cm and the heights of the triangles ABD and BCD are, respectively, 6 cm, 8 cm. Find the area of the quadrilateral ABCD (in  $\text{cm}^2$ ).

- Ans
- 1. 140
  - 2. 120
  - 3. 148
  - 4. 1282

Q.9 Chords AB and CD of a circle, when produced, meet at a point P outside the circle. If AB = 6 cm, CD = 3 cm and PD = 5 cm, then PB is equal to:

- Ans
- 1. 9 cm
  - 2. 8 cm
  - 3. 4 cm
  - 4. 6 cm

Q.10 A certain sum of money amounts to ₹1,860 in 2 years and to ₹2,130 in  $3\frac{1}{2}$  years at simple interest. Find the sum and the rate of interest, respectively.

- Ans
- 1. ₹1,500, 12%
  - 2. ₹1,200, 10%
  - 3. ₹1,500, 15%
  - 4. ₹1,200, 12%

Q.11 The given chart represents the sales of automobiles in India (by type, in million units) from the year 2011 to 2014. Study the chart and answer the question that follows.

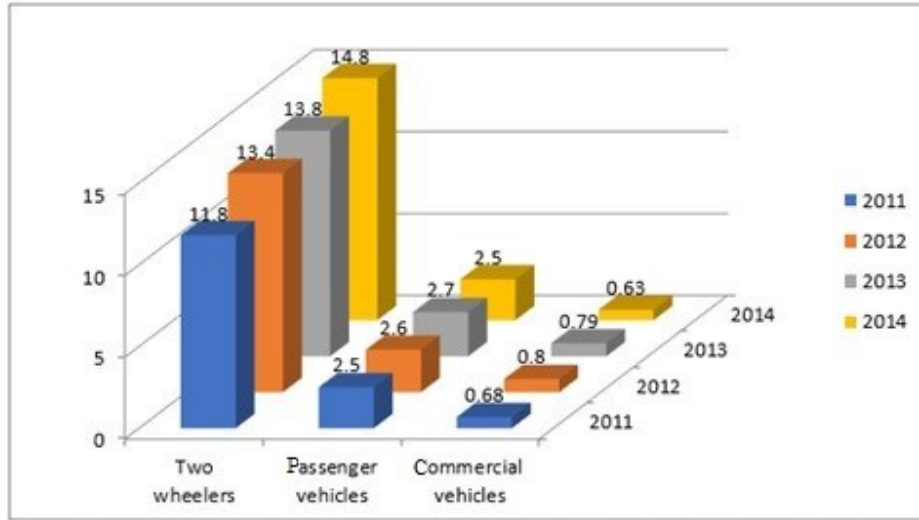

The number of commercial vehicles sold in 2012 was approximately what percentage of the total number of vehicles sold in 2011? (Correct to two decimal places)

- Ans
- 1. 6.12%
  - 2. 5.34%
  - 3. 4.56%
  - 4. 3.88%

Q.12 With a uniform speed, a car covers a distance in 16 hours. Had the speed been increased by 20 km/h, the same distance would have been covered in 12 hours. The total distance covered by the car is:

- Ans
- 1. 720 km
  - 2. 1080 km
  - 3. 960 km
  - 4. 480 km

Q.13 The centres of two circles of radii 20 cm and 32 cm are 60 cm apart. What is the ratio of the length of the direct common tangent to the length of the transverse common tangent to these circles?

- Ans
- 1.  $3\sqrt{3}:\sqrt{7}$
  - 2.  $3\sqrt{2}:\sqrt{7}$
  - 3.  $3\sqrt{7}:\sqrt{3}$
  - 4.  $7\sqrt{3}:3$

Q.14 In a triangle PQR, RS intersects PQ at point S. The sides of the triangle QR = 36 cm, SQ = 27 cm, RS = 18 cm and  $\angle QRS = \angle QPR$ . What is the ratio of the perimeter of  $\triangle PRS$  to that of  $\triangle QSR$ ?

Ans

1.  $\frac{8}{6}$

2.  $\frac{9}{12}$

3.  $\frac{7}{9}$

4.  $\frac{5}{8}$

Q.15 A merchant sells 195 kg of wheat for ₹10,260 at a profit of ₹4.50 per kg of wheat. What is the cost price (in ₹, to the nearest integer) of 15 kg of wheat?

Ans

1. 722

2. 682

3. 595

4. 750

Q.16 A coat marked at ₹145 is offered at ₹ 127.6 . The rate of retail discount offered is:

Ans

1. 11%

2. 12%

3. 13%

4. 10%

Q.17 If  $42 \div 3 + k \times 3 - 22 \div 11 + 4 = 28$ , then the value of k is:

Ans

1. 0

2. 1

3. 4

4. 2

Q.18 In an election, a candidate secures 40% of the votes, but is defeated by the only other candidate with a majority of 298 votes. Find the total number of votes recorded.

Ans

1. 1,470

2. 1,270

3. 1,490

4. 1,290

Q.19 The sides AB and AC of  $\triangle ABC$  are produced to points D and E, respectively. The bisectors of  $\angle CBD$  and  $\angle BCE$  meet at P. If  $\angle A = 72^\circ$ , then the measure of  $\angle P$  is:

Ans

1.  $55^\circ$

2.  $65^\circ$

3.  $54^\circ$

4.  $35^\circ$

- Q.20 The cost of 21 pencils and 9 pens is ₹276, and the cost of 6 pencils and 3 pens is ₹84. The cost of 1 pencil and 1 pen is: Ans
- 1. ₹20
  - 2. ₹10
  - 3. ₹40
  - 4. ₹30

Q.21 If  $4\sin^2\theta - 4\sqrt{3}\sin\theta + 3 = 0$ , then find the value of  $\theta$ . ( $0 < \theta < 90^\circ$ )

- Ans
- 1.  $30^\circ$
  - 2.  $75^\circ$
  - 3.  $60^\circ$
  - 4.  $45^\circ$

Q.22 A public library has an average attendance of 410 on Sundays and 230 for the remaining days. The average attendance per day of a month of 30 days beginning with Sunday would be:

- Ans
- 1. 230
  - 2. 254
  - 3. 320
  - 4. 260

Q.23 Due to decrease in manpower, the production in a factory decreases by 25%. By what per cent should the working hours be increased to restore the original production?

- Ans
- 1. 25%
  - 2. 50%
  - 3.  $43\frac{6}{7}\%$
  - 4.  $33\frac{1}{3}\%$

Q.24 Two numbers are, respectively, 30% and 40% more than the third number. The ratio of the second number to the first number is:

- Ans
- 1. 26:28
  - 2. 14:13
  - 3. 39:42
  - 4. 13:14

Q.25 Total number of students in different subjects of a college and percentage of girls and boys are shown in the below table.

Girls students and boys student are NOT having multiple subjects.

Subjects	Number of Students	Girls %	Boys %
Mathematics	840	40	60
Chemistry	220	70	30
Physics	450	30	70
Biology	200	80	20

What is the ratio of girl students of Mathematics and Chemistry to the number of boy students of Physics and Biology?

- Ans
- 1. 49 : 39
  - 2. 36 : 49
  - 3. 61 : 98
  - 4. 98 : 71

Section : General Awareness

1. \_\_\_\_\_ was posthumously conferred the second-highest civilian award in India, the Padma Vibhushan in the field of public affairs in 2023.

- Ans
- 1. GMC Balayogi
  - 2. Dilip Mahalanabis
  - 3. Mulayam Singh Yadav
  - 4. Balkrishna Doshi

2. A proton bonds to the oxygen atom of a solvent water to give a \_\_\_\_\_ hydronium ion.

- Ans
- 1. square pyramid
  - 2. trigonal pyramidal
  - 3. tetrahedral
  - 4. square planar

3. In July 2021, which state government announced the creation of an independent department to protect and preserve the 'faith, culture and traditions of tribes and indigenous communities' of the state?

- Ans
- 1. Uttar Pradesh
  - 2. Bihar
  - 3. Karnataka
  - 4. Assam

Q.4 Who among the following is a Choreographer in Indian film Industry?

- Ans
- 1. Anu Malik
  - 2. Pritam
  - 3. Prabhu Deva
  - 4. Arijit Singh

Q.5 Which does social networking service place the biggest emphasis on professional networking?

- Ans
- 1. Facebook
  - 2. Google+
  - 3. LinkedIn
  - 4. Twitter

Q.6 'Lai-Phi' and 'Chin-Phi' are the cultural costumes of which state?

- Ans
- 1. Nagaland
  - 2. Uttarakhand
  - 3. Manipur
  - 4. Sikkim

Q.7 In MS Word, which option allows you to copy the selected text or object to the Clipboard while simultaneously removing it from its original location?

- Ans
- 1. Drag-and-Drop
  - 2. Paste
  - 3. Copy
  - 4. Cut

Q.8 The headquarters of the Indian Institute of Tourism and Travel Management are located at:

- Ans
- 1. Bhuvneshwar
  - 2. New Delhi
  - 3. Guwahati
  - 4. Gwalior

Q.9 In April 2022, Chief Justice of India NV Ramana recommended the creation of an "independent umbrella institution", so as to bring various agencies under one roof". Which of the following agencies did he suggest be brought under this umbrella?

- Ans
- 1. ED, CBI and SFIO
  - 2. SFIO and CBI
  - 3. ED and NIA
  - 4. CBI, SFIO and NIA

Q.10 Gurpurab is celebrated to commemorate the birthday of Guru Nank dev ji. He was the \_\_\_\_\_ guru of Sikhs?

- Ans
- 1. second
  - 2. third
  - 3. first
  - 4. fourth

Q.11 In which direction is the general elevation of the peninsular plateau of India?

- Ans
- 1. From North to South
  - 2. From West to East
  - 3. From South to North
  - 4. From East to West

Q.12 All historical monuments have signages with instructions that public should not write on the walls. To which fundamental duty does the given statement belong?

- Ans
- 1. To develop the scientific temper
  - 2. To defend the country and render national service
  - 3. To promote harmony and spirit of common brotherhood
  - 4. To safeguard public property and to abjure violence

Q.13 Where is the largest football stadium in India located?

- Ans
- 1. Kolkata
  - 2. Goa
  - 3. Bengaluru
  - 4. New Delhi

Q.14 In which of the following years was the National Anthem adopted in its Hindi version by the Constituent Assembly?

- Ans
- 1. 1947
  - 2. 1950
  - 3. 1942
  - 4. 1954

Q.15 \_\_\_\_\_ oblong orbit overlaps the orbit of Neptune.

- Ans
- 1. Mars'
  - 2. Pluto's
  - 3. Jupiter's
  - 4. Venus'

Q.16 Match the columns.

**List I**

- i. National Manufacturing Policy
- ii. Make in India initiative
- iii. Startup India scheme
- iv. Smart City Project

**List II**

- a. 2014
- b. 2016
- c. 2011
- d. 2015

- Ans
- 1. i-d, ii-c, iii-a, iv-b
  - 2. i-b, ii-a, iii-d, iv-c
  - 3. i-c, ii-a, iii-b, iv-d
  - 4. i-c, ii-d, iii-b, iv-a

Q.17 Lakshmibai National College of Physical Education is located at \_\_\_\_\_.

- Ans
- 1. Shahdara, Delhi
  - 2. Patiala, Punjab
  - 3. Gwalior, Madhya Pradesh
  - 4. Thiruvananthapuram, Kerala

Q.18 What is the literacy rate of India as per the National Survey of India-2022?

- Ans
- 1. 78.3%
  - 2. 74.2%
  - 3. 72.1%
  - 4. 77.7%

Q.19 Which of the following word sequences is correct as per the Preamble to the Constitution?

- Ans
- 1. Sovereign, socialist, secular, democratic, republic
  - 2. Socialist, secular, democratic, republic, sovereign
  - 3. Secular, democratic, secular, socialist, sovereign
  - 4. Sovereign, secular, socialist, democratic, republic



**Q.20** Which non-essential amino acid is synthesised by the hydroxylation of phenylalanine in a reaction catalysed by phenylalanine hydroxylase?

- Ans**
- 1. Glutamine
  - 2. Tyrosine
  - 3. Cysteine
  - 4. Glycine

**Q.21** Who invaded India during the rule of Tughlaq Dynasty?

- Ans**
- 1. Timur
  - 2. Mahmud of Ghazni
  - 3. Chengiz Khan
  - 4. Muhammad Ghori

**Q.22** What is the impact of proportional taxes?

- Ans**
- 1. Increases the marginal propensity to consume
  - 2. Reduces the autonomous expenditure multiplier
  - 3. Increases the induced expenditure multiplier
  - 4. Increases the autonomous expenditure multiplier

**Q.23** Annamacharya composed Sankirtans in praise of which God?

- Ans**
- 1. Lord Rama
  - 2. Lord Krishna
  - 3. Lord Venkateshwara
  - 4. Lord Shiva

**Q.24** Which important event that started in 1930 played a significant role in motivating and mobilizing Indians to join the non-violent movement for independence?

- Ans**
- 1. Swadeshi movement
  - 2. Gadar Movement
  - 3. Quit India Movement
  - 4. Salt Satyagraha

**Q.25** What are the standard measurements of a cricket pitch?

- Ans**
- 1. 20 yards by 12 ft
  - 2. 22 yards by 12 ft
  - 3. 20 yards by 10 ft
  - 4. 22 yards by 10 ft

## Combined Higher Secondary Level Examination 2024 Tier I

Exam Date	10/07/2024
Exam Time	5:15 PM - 6:15 PM
Subject	CHSL Exam 2024 Tier I

### Section : English Language

1. Select the option with the correct use of article(s).

- Ans
- 1. William Wordsworth was a romantic poet. He did things in an unusual manner.
  - 2. William Wordsworth was romantic poet. He did things in an unusual manner.
  - 3. William Wordsworth was the romantic poet. He did things in a unusual manner.
  - 4. William Wordsworth was a romantic poet. He did things in a unusual manner.

2. The following sentence has been divided into four segments. Identify the segment that contains a grammatical error.

The manager noticed / that Pragya / was first to reach / the office on Saturday.

- Ans
- 1. that Pragya
  - 2. The manager noticed
  - 3. was first to reach
  - 4. the office on Saturday.

3. Parts of the following sentence have been given as options. Select the option that contains an error. The chief guest gave out prizes to the meritorious students of the school.

- Ans
- 1. of the school.
  - 2. gave out prizes
  - 3. to the meritorious students
  - 4. The chief guest

Q.4 The following sentence has been split into four segments. Identify the segment that contains a grammatical error.

Mathematics help/ in developing/ the logical mindset /of students.

- Ans
- 1. in developing
  - 2. the logical mindset
  - 3. Mathematics help
  - 4. of students

**Comprehension:**

In the following passage, some words have been deleted. Read the passage carefully and select the most appropriate option to fill in each blank.

Water is 1. \_\_\_\_\_ for life and for good health. Not only is it necessary for us to be able to meet our daily needs but safe drinking water can 2. \_\_\_\_\_ many water-related diseases. India has one of the largest number of cases of 3. \_\_\_\_\_ such as diarrhoea, dysentery, and cholera. Over 1,600 Indians, most of them children below the age of five, 4. \_\_\_\_\_ die every day because of water-related diseases. These deaths can be prevented if people have 5. \_\_\_\_\_ to safe drinking water.

**SubQuestion No : 5****Q.5 Select the most appropriate option to fill in blank 1.**

- Ans
- 1. primary
  - 2. essential
  - 3. intrinsic
  - 4. insistent

**Comprehension:**

In the following passage, some words have been deleted. Read the passage carefully and select the most appropriate option to fill in each blank.

Water is 1. \_\_\_\_\_ for life and for good health. Not only is it necessary for us to be able to meet our daily needs but safe drinking water can 2. \_\_\_\_\_ many water-related diseases. India has one of the largest number of cases of 3. \_\_\_\_\_ such as diarrhoea, dysentery, and cholera. Over 1,600 Indians, most of them children below the age of five, 4. \_\_\_\_\_ die every day because of water-related diseases. These deaths can be prevented if people have 5. \_\_\_\_\_ to safe drinking water.

**SubQuestion No : 6****Q.6 Select the most appropriate option to fill in blank 2.**

- Ans
- 1. forbid
  - 2. prevent
  - 3. restrain
  - 4. hamper

**Comprehension:**

In the following passage, some words have been deleted. Read the passage carefully and select the most appropriate option to fill in each blank.

Water is 1. \_\_\_\_\_ for life and for good health. Not only is it necessary for us to be able to meet our daily needs but safe drinking water can 2. \_\_\_\_\_ many water-related diseases. India has one of the largest number of cases of 3. \_\_\_\_\_ such as diarrhoea, dysentery, and cholera. Over 1,600 Indians, most of them children below the age of five, 4. \_\_\_\_\_ die every day because of water-related diseases. These deaths can be prevented if people have 5. \_\_\_\_\_ to safe drinking water.

**SubQuestion No : 7****Q.7 Select the most appropriate option to fill in blank 3.**

- Ans
- 1. diseases
  - 2. distress
  - 3. laments
  - 4. sufferings

**Comprehension:**

In the following passage, some words have been deleted. Read the passage carefully and select the most appropriate option to fill in each blank.

Water is 1. \_\_\_\_\_ for life and for good health. Not only is it necessary for us to be able to meet our daily needs but safe drinking water can 2. \_\_\_\_\_ many water-related diseases. India has one of the largest number of cases of 3. \_\_\_\_\_ such as diarrhoea, dysentery, and cholera. Over 1,600 Indians, most of them children below the age of five, 4. \_\_\_\_\_ die every day because of water-related diseases. These deaths can be prevented if people have 5. \_\_\_\_\_ to safe drinking water.

**SubQuestion No : 8****Q.8 Select the most appropriate option to fill in blank 4.**

- Ans
- 1. distinctly
  - 2. assuredly
  - 3. reportedly
  - 4. ostensibly

**Comprehension:**

In the following passage, some words have been deleted. Read the passage carefully and select the most appropriate option to fill in each blank.

Water is 1. \_\_\_\_\_ for life and for good health. Not only is it necessary for us to be able to meet our daily needs but safe drinking water can 2. \_\_\_\_\_ many water-related diseases. India has one of the largest number of cases of 3. \_\_\_\_\_ such as diarrhoea, dysentery, and cholera. Over 1,600 Indians, most of them children below the age of five, 4. \_\_\_\_\_ die every day because of water-related diseases. These deaths can be prevented if people have 5. \_\_\_\_\_ to safe drinking water.

**SubQuestion No : 9**

**Q.9** Select the most appropriate option to fill in blank 5.

- Ans
- 1. entrance
  - 2. access
  - 3. providence
  - 4. accession

**Q.10** Select the most appropriate option that can substitute the underlined segment in the following sentence.  
Had you been to Dubai, I would also go with you.

- Ans
- 1. I shall be gone
  - 2. I will have went
  - 3. I would has also gone
  - 4. I would have gone

**Q.11** Select the most appropriate meaning of the given idiom.  
Costing an arm and a leg

- Ans
- 1. Very attractive and cheap
  - 2. Very rough and tough
  - 3. Very costly and luxurious
  - 4. Very entertaining and jovial

**Q.12** Select the most appropriate ANTONYM of the word given in brackets to fill in the blank.  
You can't stop the \_\_\_\_\_ (outflow) of current.

- Ans
- 1. deluge
  - 2. influx
  - 3. torrent
  - 4. income

**Q.13** Select the most appropriate ANTONYM of the given word.  
Massive

- Ans
- 1. Tiny
  - 2. Tall
  - 3. Formidable
  - 4. Heavy

**Q.14** Select the most appropriate option that can substitute the underlined word in the given sentence.

She argued against the unnecessary split in the committee.

- Ans
- 1. division
  - 2. blend
  - 3. combination
  - 4. mix

Q.15 Select the most appropriate option that can substitute the underlined segment in the following sentence.  
This serum contains ingredients enabling the hair to grow.

- Ans
- 1. the enable grow hair
  - 2. for growth hair
  - 3. for growing many hair
  - 4. that enable the hair to grow

Q.16 Select the INCORRECTLY spelt word.

- Ans
- 1. Dilemma
  - 2. Committee
  - 3. Warranty
  - 4. Neice

Q.17 Select the word segment from the options that can substitute the bracketed word segment meaningfully.  
Telangana artists (are know for the amazing bronze castings).

- Ans
- 1. Are known for their amazing bronze castings
  - 2. Have been knew to the amazing bronze castings
  - 3. Is known to the amazing bronze castings
  - 4. Have to know the amazing bronze castings

Q.18 Select the most appropriate option that can substitute the underlined segment in the given sentence. If there is no need to substitute it, select 'No substitution required'.

It has been found that the trees are being destroyed by a moth.

- Ans
- 1. have destroyed
  - 2. is being destroyed
  - 3. have been destroying
  - 4. No substitution required

Q.19 Select the most appropriate option to fill in the blank.

Tom is trying to \_\_\_\_\_ as soon as possible.

- Ans
- 1. receive a job
  - 2. experience a job
  - 3. get a job
  - 4. learn a job

Q.20 Select the most appropriate meaning of the given idiom.  
Going through a sticky patch

- Ans
- 1. To experience a bad period in life
  - 2. Try to paste something unsuccessfully
  - 3. To walk on a muddy road
  - 4. To feel sad

Q.21 Select the most appropriate ANTONYM of the underlined word in the given sentence.  
His feeble opponent was no match to him and ultimately he won the challenge.

- Ans
- 1. Strong
  - 2. Mystic
  - 3. Major
  - 4. Intelligent

Q.22 Select the most appropriate ANTONYM of the given word.

Impulsive

- Ans
- 1. Passive
  - 2. Aggressive
  - 3. Hasty
  - 4. Cautious

Q.23 Identify the incorrectly spelt word and select its correct spelling.  
There are a number of artists currently creating unique, collectble teapots.

- Ans
- 1. currantly
  - 2. collectable
  - 3. collectibile
  - 4. currintly

Q.24 Select the most appropriate ANTONYM of the word 'Commence' from the given sentence.  
Let's put an end to this discussion about voodoo and instead talk about something amusing.

- Ans
- 1. end
  - 2. voodoo
  - 3. amusing
  - 4. discussion

Q.25 Select the most appropriate synonym of the given word.  
Evasive

- Ans
- 1. Cohesive
  - 2. Ambiguous
  - 3. Accessible
  - 4. Abrasive

Section : General Intelligence

Q.1 How many rectangles are there in the following figure?

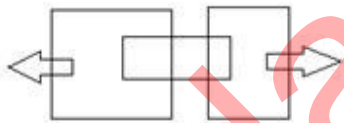

- Ans
- 1. 10
  - 2. 8
  - 3. 11
  - 4. 7

2. What should come in place of the question mark (?) in the given series based on the English alphabetical order?  
DGB, GKG, JOL, MSQ, ?

- Ans
- 1. RXV
  - 2. PWV
  - 3. QWU
  - 4. PVT

Q.3 What will come in the place of the question mark (?) in the following equation, if '+' and '×' are interchanged and '-' and '÷' are interchanged?

$$123 - 41 \times 14 + 2 \div 7 = ?$$

- Ans
- 1. 20
  - 2. 22
  - 3. 23
  - 4. 24

Q.4 In a certain code language,  
'M & N' means 'M is the wife of N',  
'M @ N' means 'M is the son of N',  
'M \$ N' means 'M is the mother of N'.  
Based on the above, how is R related to O if 'N \$ O @ P @ Q & R'?

- Ans
- 1. Father's father
  - 2. Mother's brother
  - 3. Father's brother
  - 4. Mother's father

Q.5 Which two numbers should be interchanged to make the given equation correct?

$$35 + (25 \times 3 - 45) \div 2 + (15 \times 4) = 125$$

(NOTE: Numbers must be interchanged and not the constituent digits e.g. if 2 and 3 are to be interchanged in the equation  $43 \times 3 + 4 \div 2$ , then interchanged equation is  $43 \times 2 + 4 \div 3$ )

- Ans
- 1. 2 and 15
  - 2. 25 and 35
  - 3. 15 and 25
  - 4. 35 and 45

Q.6 In a certain code language, 'try something new' is coded as 'db kl jk' and 'something hurt him' is coded as 'db pt uk'. How is 'something' coded in that language?

- Ans
- 1. uk
  - 2. jk
  - 3. db
  - 4. kl

Q.7 Which figure should replace the question mark (?) if the following figure series were to be continued?

O	□	S	O	↑	S	O	↑	
S		↑		O		N		
↑		2		N		P		
N	2	P	N	2	P	☆	2	?

Ans

✗ 1.

↑	☆
O	
N	
2	P

✗ 2.

↑	N
O	
2	
P	☆

✗ 3.

N	☆
P	
2	
↑	O

✓ 4.

N	O
↑	
2	
P	☆

Q.8 Select the set in which the numbers are related in the same way as are the numbers of the following sets.  
 (NOTE : Operations should be performed on the whole numbers, without breaking down the numbers into its constituent digits. E.g. 13 – Operations on 13 such as adding /subtracting /multiplying etc. to 13 can be performed. Breaking down 13 into 1 and 3 and then performing mathematical operations on 1 and 3 is not allowed)  
 (32, 35, 201)  
 (26, 29, 165)

- Ans
- ✗ 1. (28, 31, 197)
  - ✗ 2. (34, 37, 203)
  - ✗ 3. (39, 42, 256)
  - ✓ 4. (23, 26, 147)

Q.9 Select the word-pair that best represents a similar relationship to the one expressed in the pair of words given below.

(The words must be considered as meaningful English words and must not be related to each other based on the number of letters/number of consonants/vowels in the word)

Lend : Borrow

- Ans
- ✗ 1. Cold : Frigid
  - ✓ 2. Cruel : Kind
  - ✗ 3. Silent : Quiet
  - ✗ 4. Neat : Tidy



Q.10 In a certain code language, 'RIVER' is coded as 'SJWFS' and 'SYSTEM' is coded as 'TZTUFN'. How is 'PACK' coded in that language?

- Ans
- 1. QCEL
  - 2. RCEK
  - 3. QBDL
  - 4. RBDL

Q.11 Select the option figure in which the given figure (X) is embedded as its part (rotation is NOT allowed).



(X)

Ans

1.

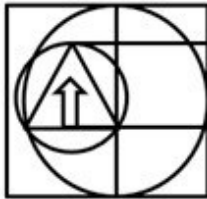

2.

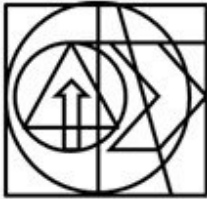

3.

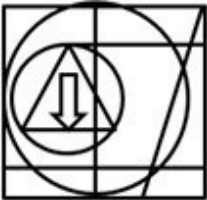

4.



Adda247 Marathi

Q.12 Select the option in which the given figure is embedded (rotation is NOT allowed).

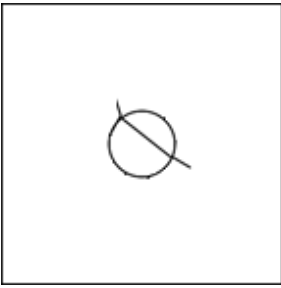

Ans

✗ 1.



✗ 2.

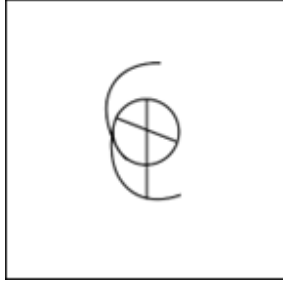

✗ 3.

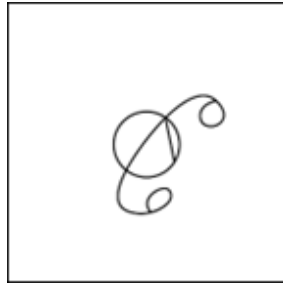

✓ 4.

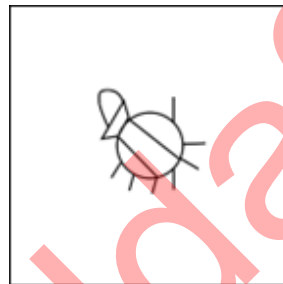

Q.13 What should come in place of ? in the given series?

33 32 35 34 37 ?

Ans

✗ 1. 38

✗ 2. 37

✓ 3. 36

✗ 4. 40

Q.14 Select the correct mirror image of the given figure when the mirror is placed at MN as shown below.

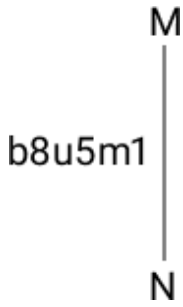

- Ans
- 1.  $\text{p8u2w1}$
  - 2.  $\text{1m2u8d}$
  - 3.  $\text{b8u5m1}$
  - 4.  $\text{1w5u8q}$

Q.15 102 is related to 34 following a certain logic. Following the same logic, 171 is related to 57. To which of the following is related 237 following the same logic?

(NOTE : Operations should be performed on the whole numbers, without breaking down the numbers into its constituent digits. E.g. 13 – Operations on 13 such as adding /deleting /multiplying etc., to 13 can be performed. Breaking down 13 into 1 and 3 and then performing mathematical operations on 1 and 3 is not allowed.)

- Ans
- 1. 73
  - 2. 79
  - 3. 71
  - 4. 77

Q.16 What will come in the place of the question mark (?) in the following equation, if '+' and '-' are interchanged and '×' and '÷' are interchanged?

$$24 \div 10 + 68 \times 2 - 16 = ?$$

- Ans
- 1. 242
  - 2. 222
  - 3. 252
  - 4. 232

Q.17 What would be the number on the opposite side of '7' if the given sheet is folded to form a cube?

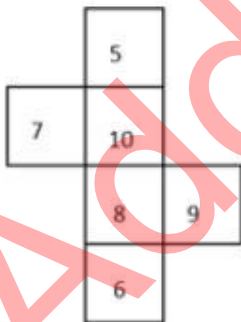

- Ans
- 1. 9
  - 2. 8
  - 3. 6
  - 4. 5

Q.18 What will come in the place of the question mark (?) in the following equation, if '+' and '-' are interchanged and '×' and '÷' are interchanged?

$$92 \times 2 - 13 + 2 \div 6 = ?$$

- Ans
- 1. 48
  - 2. 47
  - 3. 46
  - 4. 49

Q.19 If 17 December 2012 was Monday, then what was the day of the week on 18 November 2020?

- Ans
- 1. Tuesday
  - 2. Sunday
  - 3. Thursday
  - 4. Wednesday

Q.20 QTWA is related to ZCFJ in a certain way based on the English alphabetical order. In the same way, MKBZ is related to VIKI. To which of the following is EYCM related, following the same logic?

- Ans
- 1. NLVH
  - 2. NLHV
  - 3. NVHL
  - 4. NHLV

Q.21 Four letter-clusters have been given, out of which three are alike in some manner and one is different. Select the one that is different.

(Note: The odd one out is not based on the number of consonants/vowels or their position in the letter cluster)

- 1) FGNOP
- 2) IJQRS
- 3) OPWXY
- 4) RSXYZ

- Ans
- 1. OPWXY
  - 2. IJQRS
  - 3. RSXYZ
  - 4. FGNOP

Q.22 If 27 September 2001 was a Thursday, then what was the day of the week on 22 October 2009?

- Ans
- 1. Thursday
  - 2. Wednesday
  - 3. Friday
  - 4. Sunday

Q.23 Three statements are followed by conclusions numbered I, II. You have to consider these statements to be true, even if they seem to be at variance with commonly known facts. Decide which of the given conclusions logically follow/s from the given statement.

Statements:

Some leaves are trees.

All stones are grain.

Some grains are leaves.

Conclusion (I): All grains are trees.

Conclusion (II): Some leaves are stones.

- Ans
- 1. Only conclusion (II) follows.
  - 2. Neither conclusion (I) nor (II) follows.
  - 3. Both conclusions (I) and (II) follow.
  - 4. Only conclusion (I) follows.

**Q.24** Select the term from among the given options that can replace the question mark (?) in the following series based on the English alphabetical order.

XYZ, YAC, ?, AEI, BGL, CIO

- Ans**
- ✓ 1. ZCF
  - ✗ 2. ZAB
  - ✗ 3. YZL
  - ✗ 4. MOP

**Q.25** A square sheet of paper is folded along the dotted line successively along the directions shown and is then punched in the last. How would the paper look when unfolded?

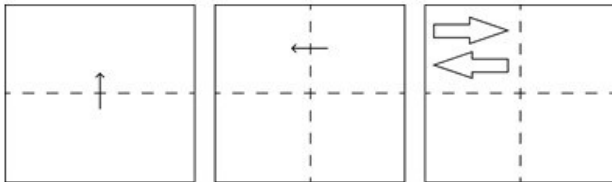

- Ans**
- ✗ 1.
  - ✗ 2.
  - ✗ 3.
  - ✓ 4.

Section : Quantitative Aptitude

**Q.1** If the surface areas of two spheres are in the ratio of 49 : 81, then find the ratio of their volumes.

- Ans**
- ✗ 1. 27 : 64
  - ✗ 2. 125 : 512
  - ✓ 3. 343 : 729
  - ✗ 4. 216 : 512

Q.2 For what value of  $k$  ( $k > 0$ ) will the lines  $5x + ky - 2 = 0$  and  $(k + 1)x + 4y + 7 = 0$  be parallel?

- Ans
- 1. 4
  - 2. 3
  - 3. 2
  - 4. 5

Q.3 P completes a work in 12 days and Q in 24 days. In how many days P and Q working together can complete the same work?

- Ans
- 1. 12 days
  - 2. 8 days
  - 3. 6 days
  - 4. 16 days

Q.4 The details of books of 6 subjects on the first floor of the college library are given in the following table.

	English	French	Computers	Circuit Theory	Maths	Graph Theory
No. of books	7532	308	14,308	9948	17,462	642

The ratio of Maths and Computers to Circuit Theory and Graph Theory is:

- Ans
- 1. 1 : 3
  - 2. 2 : 1
  - 3. 3 : 1
  - 4. 2 : 3

Q.5 The following table gives the percentage of marks obtained by six students in five different subjects in an examination.

The numbers in the brackets give the maximum marks in each subject.

Student's Name	Subjects (Maximum marks)				
	Maths(150)	English(130)	Hindi(120)	Physics(100)	Chemistry(60)
Aanya	90	100	90	90	80
Aarav	100	80	90	70	70
Lavi	90	90	80	60	50
Monika	80	70	100	50	100
Devyansh	50	60	100	100	90
Tanmay	60	80	70	70	80

What are the average marks obtained by all the six students in Hindi?

- Ans
- 1. 172
  - 2. 127
  - 3. 610
  - 4. 106

Q.6 A solid metallic cube having surface area of  $54 \text{ cm}^2$  is melted to form smaller cubes of surface area  $\frac{8}{12} \text{ cm}^2$  each. Find the number of smaller cubes.

- Ans
- 1. 729
  - 2. 216
  - 3. 343
  - 4. 512

Q.7 If the surface area of the sphere is  $616 \text{ cm}^2$ , then the radius of the sphere is equal to:

- Ans
- 1. 18.0cm
  - 2. 14.0cm
  - 3. 7.0cm
  - 4. 3.5cm

Q.8 In an election between two candidates, 15% of the votes were invalid and one candidate got 52% of the total valid votes. If the total number of votes was 8000, what was the number of valid votes that the other candidate got?

- Ans
- 1. 3264
  - 2. 3536
  - 3. 3840
  - 4. 6800

Q.9 When  $2^{256}$  is divided by 17, the remainder would be:

- Ans
- 1. 2
  - 2. 5
  - 3. 0
  - 4. 1

Q.10 A number is divisible by 11 if and only if the difference of the sum of the digits in the even and odd positions in the number is:

- Ans
- 1. 0
  - 2. 1
  - 3. 0 or multiple of 11
  - 4. 11

Q.11 In  $\Delta ABC$ , if  $AB = \sqrt{3}$  units,  $BC = 1$  unit and  $AC = 2$  units, then  $\angle ACB$  is equal to:

- Ans
- 1.  $60^\circ$
  - 2.  $90^\circ$
  - 3.  $30^\circ$
  - 4.  $45^\circ$

Q.12

Study the given pie-charts and answer the question that follows.

The pie-charts show the characteristics of foreign tourists visiting India during a given year.

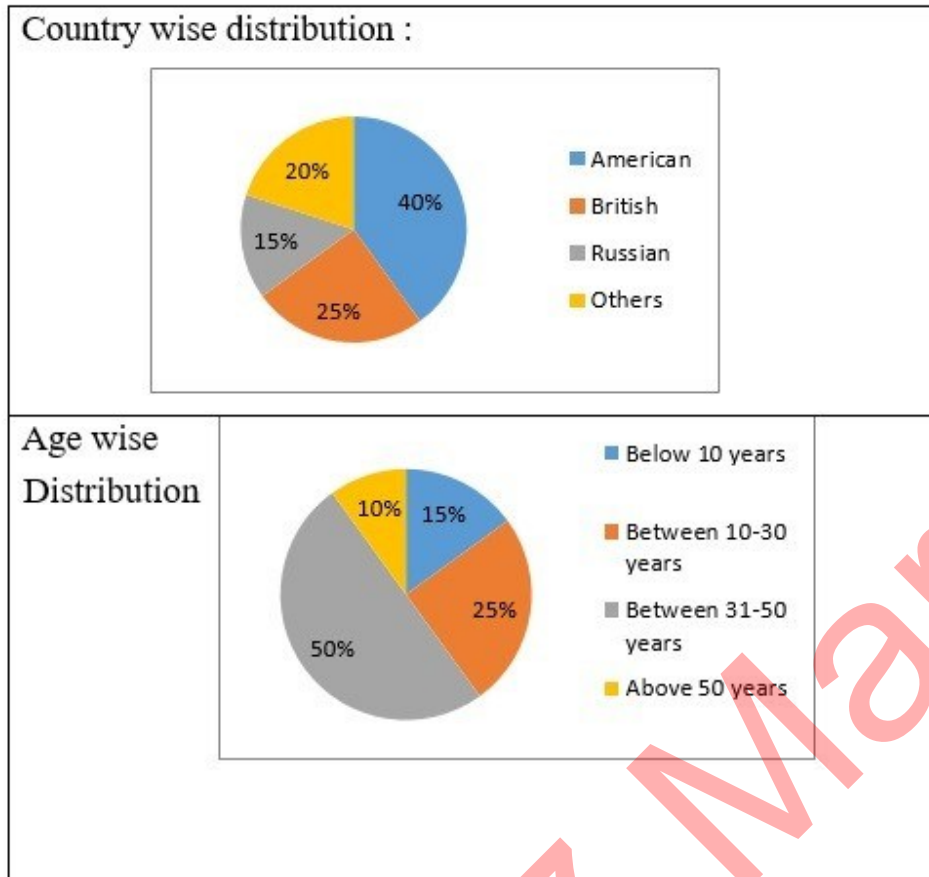

If in a given year, 2,50,000 tourists visited India and the age wise distribution of data applies to all the countries, then what is the ratio of American tourists below 10 years to the other tourists above 50 years?

- Ans
- 1. 1 : 3
  - 2. 3 : 1
  - 3. 5 : 1
  - 4. 1 : 5

Q.13 Two numbers are respectively 61% and 35% less than a third number. The first number is what percentage of the second number?

- Ans
- 1. 24%
  - 2. 48%
  - 3. 30%
  - 4. 60%

Q.14 Two chords AB and CD of a circle are produced to intersect each other at a point P outside the circle. If AB = 7 cm, BP = 4.2 cm and PD = 2.8 cm, then the length of CD is:

- Ans
- 1. 11 cm
  - 2. 18 cm
  - 3. 16 cm
  - 4. 14 cm



Q.15 A costs thrice as much as B. A is sold at a loss of 10%, and B is sold at  $\frac{5}{4}$  of its own price. If the selling price of A is ₹5,800 more than the selling price of B, then the cost price of A is:

- Ans
- 1. ₹4,000
  - 2. ₹12,000
  - 3. ₹15,000
  - 4. ₹9,600

Q.16 If '÷' means '×', '×' means '÷', '+' means '-', '-' means '+', then  $47 \div (10 \times 5) + (4 - 5) - 6$  is:

- Ans
- 1. 91
  - 2. 59
  - 3. 79
  - 4. 100

Q.17 The given pie-diagram shows the expenditure incurred on the preparation of a book by a publisher, under various heads. Study the pie-diagram and answer the question that follows.

Various Expenditures (in percentage) incurred in Publishing a Book

■ A-Paper ■ B-Printing ■ C-Binding ■ D-Royalty ■ E-Miscellaneous

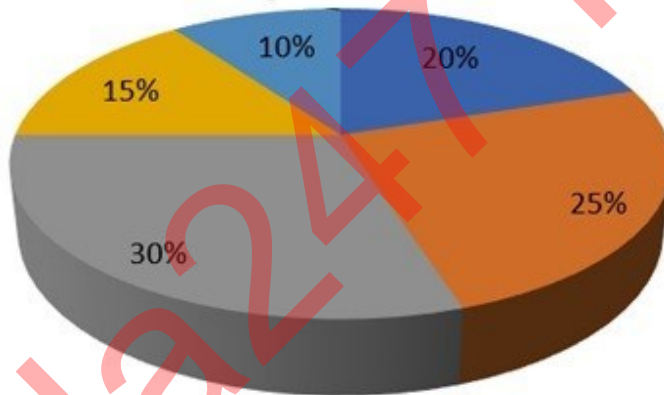

Which two expenditures together will form an angle of  $108^\circ$  at the centre of the pie-diagram?

- Ans
- 1. A and D
  - 2. B and E
  - 3. D and E
  - 4. A and E

Q.18 If the average weight of 40 apples is 33 kg and that of 32 apples is 60 kg, then the average weight (in kg) of all the apples is:

- Ans
- 1. 46.5
  - 2. 45
  - 3. 44
  - 4. 45.2

Q.19 Evaluate  $(9\sin \theta + 2 \cos \theta) / (9\sin \theta - 2\cos \theta)$ , if  $3 \tan \theta = 4$ .

Ans

1.  $\frac{9}{7}$

2.  $\frac{5}{7}$

3.  $\frac{7}{5}$

4.  $\frac{6}{5}$

Q.20 In an election between two candidates, Ananth and Aravind, Ananth got 55% of the total valid votes, and 20% of the votes were invalid. If the total number of votes was 30,000, find the number of valid votes that Aravind got.

Ans

1. 10800

2. 1080

3. 24000

4. 13200

Q.21 In an isosceles triangle, the vertex angle is four times the sum of the base angles. The measure of the square root of the vertex angle is:

Ans

1.  $16^\circ$

2.  $18^\circ$

3.  $10^\circ$

4.  $12^\circ$

Q.22 A bucket contains a mixture of milk and water in the proportion of 7: 5. If 9 litres of milk is replaced by water, then the ratio becomes 7:9. How much milk was there in the bucket initially?

Ans

1. 36 litres

2. 35 litres

3. 30 litres

4. 25 litres

Q.23 Ramu invested some money at 8% simple interest per annum, and it was grown up to ₹820 in 8 years. If the same sum was invested at 20% simple interest per annum for a period of 10 years, find the amount.

Ans

1. ₹1,000

2. ₹1,200

3. ₹1,320

4. ₹1,500

Q.24 A man walking at the speed of 4 km/h covers a certain distance in 6 hours and 15 minutes. If he covers the same distance by cycle in 5 hours and 10 minutes, then the speed of the cycle in km/h is:

Ans

1.  $2\frac{9}{31}$

2.  $3\frac{11}{31}$

3.  $4\frac{26}{31}$

4.  $3\frac{21}{31}$

Q.25  $\triangle ABC$  and  $\triangle PQR$  are similar. The areas of these two triangles are 289 sq.cm and 576 sq.cm, respectively. If PR = 12 cm, then AC = ?

- Ans
- 1. 7.25 cm
  - 2. 8.5 cm
  - 3. 12 cm
  - 4. 6 cm

Section : General Awareness

1. Folk music sung on the birth of a child in some Indian states like Bihar, Uttar Pradesh, etc. is called \_\_\_\_\_.

- Ans
- 1. gari
  - 2. banna
  - 3. kohbar
  - 4. sohar

2. The country's infrastructure vision for FY-2025 and the first exercise to be conducted in India is named as \_\_\_\_\_.

- Ans
- 1. National Infrastructure Plan
  - 2. National Infrastructure Pipeline
  - 3. National Infrastructure Projects
  - 4. National Infrastructure Planning

3. Which of the following books was unveiled by the Union Minister Giriraj Singh in year 2022?

- Ans
- 1. Heartfelt: The legacy of faith
  - 2. Agenda for Members of Panchayati Raj Institutions for Rural Development
  - 3. Modi @20: Dreams meet delivery
  - 4. Pandemic disruptions and Odisha's lessons in governance

Q.4 'The Life Divine', 'The Synthesis of Yoga' and 'Savitri' are the popular works of which of the following extremist freedom fighters of India?

- Ans
- 1. Lala Lajpat Rai
  - 2. Aurobindo Ghosh
  - 3. Bal Gangadhar Tilak
  - 4. Bipin Chandra Pal

Q.5 Which of the following statements accurately describes application software?

- Ans
- 1. Application software is used only by software developers and does not impact regular users.
  - 2. Application software refers to the operating system that provides a user-friendly interface to interact with the computer.
  - 3. Application software is responsible for managing and controlling computer hardware components.
  - 4. Application software is designed to perform specific tasks or functions to meet the user's needs.

Q.6 Which is the only surviving specimen of the ancient Sanskrit theatre recognised by UNESCO as a Masterpiece of the Oral and Intangible Heritage of Humanity?

- Ans
- 1. Kutiyattam
  - 2. Kathakali
  - 3. Yakshagana
  - 4. Bhavai

Q.7 The velocity of circulation of money will be higher when the \_\_\_\_\_ is less than the requirements of the economy.

- Ans
- 1. velocity of money
  - 2. elasticity of money
  - 3. demand for money
  - 4. supply of money

Q.8 Suppose a mine worker asks his son, aged 9 years, to help him in his work instead of going to school. Which Article of the Constitution of India will be violated in this case?

- Ans
- 1. Article 18
  - 2. Article 24
  - 3. Article 20
  - 4. Article 29

Q.9 In 1835, who developed the process of applying a thin layer of metallic silver to one side of a clear glass pane and created the first mirror?

- Ans
- 1. CV Raman
  - 2. Victor Francis Hess
  - 3. CH Townes
  - 4. Justus von Liebig

Q.10 Where is the Kailasa temple built by Rashtrakutas located?

- Ans
- 1. Ellora
  - 2. Amravati
  - 3. Kanchi
  - 4. Hampi

Q.11 The 10<sup>th</sup> Five-Year Plan aimed at reducing poverty by:

- Ans
- 1. 2%
  - 2. 5%
  - 3. 8%
  - 4. 9%

Q.12 Which of the following is NOT mentioned in fundamental duties provided under Indian Constitution?

- Ans
- 1. To join Defence forces
  - 2. To develop scientific temper
  - 3. To safeguard public property
  - 4. To respect the national flag

Q.13 In MS Word, which option allows you to quickly remove all formatting from selected text while retaining the underlying text content?

- Ans
- 1. Clear Formatting
  - 2. Paste Special
  - 3. Cut
  - 4. Format Painter

Q.14 Which of the following statements is correct?

- Ans
- 1. Mars is the warmest planet.
  - 2. The size of Jupiter and Mars is similar.
  - 3. The size of Earth and Venus is almost similar.
  - 4. The density of Saturn is similar to that of Earth.

Q.15 Kalbelia dance, also known as the 'Sapera Dance', is the folk dance of \_\_\_\_\_.

- Ans
- 1. Madhya Pradesh
  - 2. Rajasthan
  - 3. Gujarat
  - 4. Uttar Pradesh

Q.16 In which of the following sports/games is the attacking player known as a 'raider'?

- Ans
- 1. Badminton
  - 2. Kabaddi
  - 3. Tennis
  - 4. Hockey

Q.17 On 12 February 2023, the President of India appointed the Governor of states. Which of the following is NOT correctly matched?

- Ans
- 1. Phagu Chauhan – Meghalaya
  - 2. Ramesh Baish – Maharashtra
  - 3. S Abdul Nazeer – Bihar
  - 4. Shiv Pratap Shukla – Himachal Pradesh

Q.18 Where was the 36<sup>th</sup> National Games of India held in the year 2022?

- Ans
- 1. Kerala
  - 2. Delhi
  - 3. Goa
  - 4. Gujarat

Q.19 International Kite Festival is a popular cultural festival of which state?

- Ans
- 1. Manipur
  - 2. Gujarat
  - 3. Goa
  - 4. Chhattisgarh

Q.20 In March 2023, the Government of India announced the set up of how many PM MITRA (Pradhan Mantri Mega Integrated Textile Region and Apparel) parks for the textile industry?

- Ans
- 1. 9
  - 2. 5
  - 3. 2
  - 4. 7

Q.21 The Salal Project, also called the Salal Hydroelectric Power Station, is on which river?

- Ans
- 1. Ganga
  - 2. Ravi
  - 3. Krishna
  - 4. Chenab

Q.22 When is National Javelin Day celebrated in India?

- Ans
- 1. 7<sup>th</sup> August
  - 2. 6<sup>th</sup> August
  - 3. 12<sup>th</sup> January
  - 4. 29<sup>th</sup> August

Q.23 In which of the following plants do roots arise from parts of a plant other than the radicle?

- Ans
- 1. Monstera
  - 2. Turnip
  - 3. Mustard plant
  - 4. Maize

Q.24 What is Miyan ki Todi in Hindustani music?

- Ans
- 1. Chhand
  - 2. Raag
  - 3. Kirtan
  - 4. Tanam

Q.25 What is the literacy rate of males in India as per the report published in the National Survey of India-2022?

- Ans
- 1. 83.4%
  - 2. 86.3%
  - 3. 84.7%
  - 4. 81.2%

Adda247 Marathi

## Combined Higher Secondary Level Examination 2024 Tier I

Exam Date	11/07/2024
Exam Time	9:00 AM - 10:00 AM
Subject	CHSL Exam 2024 Tier I

### Section : English Language

1. Parts of the following sentence have been given as options. Select the option that contains an error.

She was fond of walking along the path besides the lake.

- Ans
- 1. besides the lake
  - 2. along the path
  - 3. She was
  - 4. fond of walking

2. Parts of the following sentence have been underlined and given as options. Select the option that contains an error. Policeman came to my village and asked about a person who burgled a house last night.

- Ans
- 1. policeman
  - 2. a house
  - 3. my village
  - 4. a person

3. Select the option that will improve the given sentence by using the most appropriate verb.  
Soorya walking to college every day.

- Ans
- 1. Soorya is walking to college every day.
  - 2. Soorya walked to college every day.
  - 3. Soorya walk to college every day.
  - 4. Soorya have walked to college every day.

- Q.4 The following sentence has been divided into parts. One of them may contain an error. Select the part that contains the error from the given options. If you don't find any error mark 'No error' as your answer.  
Father took the newspaper / in his hand to / go through it once again.

- Ans
- 1. in his hand to
  - 2. Father took the newspaper
  - 3. go through it once again
  - 4. No error

**Comprehension:**

In the following passage, some words have been deleted. Read the passage carefully and select the most appropriate option to fill in each blank.

What is literacy? It is the golden key that (1)\_\_\_\_\_ the gates to a whole new world. It heralds the dawn of a new (2)\_\_\_\_\_. But the media hype seems to give the impression that literacy simply means the ability to sign one's name, instead of putting thumb impression. Isn't that a very (3)\_\_\_\_\_, simplistic interpretation of the word?

Taking up this narrow meaning of the word, politicians proclaim that their states have achieved 80 or 90 per cent literacy or even (4)\_\_\_\_\_. But quite often, what happens is, once the training course is over, to produce (5)\_\_\_\_\_, the neo-literates soon lapse into illiteracy.

**SubQuestion No : 5****Q.5** Select the most appropriate option to fill in blank no. 1.

- Ans**
- 1. opens
  - 2. closes
  - 3. controls
  - 4. leads

**Comprehension:**

In the following passage, some words have been deleted. Read the passage carefully and select the most appropriate option to fill in each blank.

What is literacy? It is the golden key that (1)\_\_\_\_\_ the gates to a whole new world. It heralds the dawn of a new (2)\_\_\_\_\_. But the media hype seems to give the impression that literacy simply means the ability to sign one's name, instead of putting thumb impression. Isn't that a very (3)\_\_\_\_\_, simplistic interpretation of the word?

Taking up this narrow meaning of the word, politicians proclaim that their states have achieved 80 or 90 per cent literacy or even (4)\_\_\_\_\_. But quite often, what happens is, once the training course is over, to produce (5)\_\_\_\_\_, the neo-literates soon lapse into illiteracy.

**SubQuestion No : 6****Q.6** Select the most appropriate option to fill in blank no. 2.

- Ans**
- 1. year
  - 2. day
  - 3. month
  - 4. season

**Comprehension:**

In the following passage, some words have been deleted. Read the passage carefully and select the most appropriate option to fill in each blank.

What is literacy? It is the golden key that (1)\_\_\_\_\_ the gates to a whole new world. It heralds the dawn of a new (2)\_\_\_\_\_. But the media hype seems to give the impression that literacy simply means the ability to sign one's name, instead of putting thumb impression. Isn't that a very (3)\_\_\_\_\_, simplistic interpretation of the word?

Taking up this narrow meaning of the word, politicians proclaim that their states have achieved 80 or 90 per cent literacy or even (4)\_\_\_\_\_. But quite often, what happens is, once the training course is over, to produce (5)\_\_\_\_\_, the neo-literates soon lapse into illiteracy.

**SubQuestion No : 7****Q.7** Select the most appropriate option to fill in blank no. 3.

- Ans**
- 1. limited
  - 2. daunted
  - 3. wide
  - 4. small



**Comprehension:**

In the following passage, some words have been deleted. Read the passage carefully and select the most appropriate option to fill in each blank.

What is literacy? It is the golden key that (1)\_\_\_\_\_the gates to a whole new world. It heralds the dawn of a new (2)\_\_\_\_\_. But the media hype seems to give the impression that literacy simply means the ability to sign one's name, instead of putting thumb impression. Isn't that a very (3)\_\_\_\_\_, simplistic interpretation of the word?

Taking up this narrow meaning of the word, politicians proclaim that their states have achieved 80 or 90 per cent literacy or even (4)\_\_\_\_\_. But quite often, what happens is, once the training course is over, to produce (5)\_\_\_\_\_, the neo-literates soon lapse into illiteracy.

**SubQuestion No : 8****Q.8 Select the most appropriate option to fill in blank no. 4.**

- Ans
- 1. better
  - 2. higher
  - 3. lower
  - 4. moderate

**Comprehension:**

In the following passage, some words have been deleted. Read the passage carefully and select the most appropriate option to fill in each blank.

What is literacy? It is the golden key that (1)\_\_\_\_\_the gates to a whole new world. It heralds the dawn of a new (2)\_\_\_\_\_. But the media hype seems to give the impression that literacy simply means the ability to sign one's name, instead of putting thumb impression. Isn't that a very (3)\_\_\_\_\_, simplistic interpretation of the word?

Taking up this narrow meaning of the word, politicians proclaim that their states have achieved 80 or 90 per cent literacy or even (4)\_\_\_\_\_. But quite often, what happens is, once the training course is over, to produce (5)\_\_\_\_\_, the neo-literates soon lapse into illiteracy.

**SubQuestion No : 9****Q.9 Select the most appropriate option to fill in blank no. 5.**

- Ans
- 1. education
  - 2. literates
  - 3. beginners
  - 4. pupils

**Q.10 Select the most appropriate synonym of the given word.  
Magnificent**

- Ans
- 1. Modest
  - 2. Regular
  - 3. Humble
  - 4. Splendid

**Q.11 Select the most appropriate synonym of the given word.****Indigenous**

- Ans
- 1. Aboriginal
  - 2. Artificial
  - 3. Tangible
  - 4. Literary

**Q.12 Select the most appropriate spelling of the underlined word in the given sentence.  
He lost all senisation in his legs through a cramp.**

- Ans
- 1. syansation
  - 2. sensition
  - 3. sansation
  - 4. sensation

Q.13 The following sentence has been split into four segments. Identify the segment that contains a grammatical error. When Serena / will arrive, / she will / call you.

- Ans
- 1. call you
  - 2. will arrive
  - 3. she will
  - 4. When Serena

Q.14 Select the most appropriate meaning of the given idiom.  
A sting in the tail

- Ans
- 1. An unexpected, typically unpleasant or problematic end to something
  - 2. Something which seems bad at first but contains a pleasant part at the end
  - 3. To initiate a situation that is very complicated or problematic
  - 4. A situation in which a large group has to do something to satisfy a small group

Q.15 Identify the INCORRECTLY spelt word in the following sentence.  
To avoid indigetion, it is necessary to chew food properly.

- Ans
- 1. chew
  - 2. necessary
  - 3. properly
  - 4. indigetion

Q.16 Select the most appropriate option that can substitute the underlined words in the following sentence.  
The interdisciplinary approach utilised in this study facilitates comprehensive understanding of the complex phenomenon under investigation.

- Ans
- 1. facilitated a comprehensive understanding
  - 2. will have facilitated a comprehensive understanding
  - 3. utilises a comprehensive understanding
  - 4. is facilitates a comprehensive understanding

Q.17 Select the most appropriate ANTONYM of the given word.  
Abandon

- Ans
- 1. Adopt
  - 2. Randomize
  - 3. Destroy
  - 4. Surrender

Q.18 Select the most appropriate meaning of the given idiom.  
Gift of the gab

- Ans
- 1. Witty
  - 2. Humorous
  - 3. Talent for speaking
  - 4. Talent for singing

Q.19 Select the most appropriate collocation to fill in the blank.  
Ujjwal was imprisoned for \_\_\_\_\_ a crime.

- Ans
- 1. making
  - 2. undertaking
  - 3. committing
  - 4. involving

Q.20 Identify the most appropriate ANTONYM of the given word.  
He worked alone as he did not want anyone to hamper his project.

- Ans
- 1. Care
  - 2. Help
  - 3. Impede
  - 4. Finish

Q.21 Select the most appropriate ANTONYM of the underlined word in the given sentence.  
He is not friendly with him in the office.

- Ans
- 1. Revel
  - 2. Hostile
  - 3. Gregarious
  - 4. Intelligent

Q.22 Select the most appropriate option that can substitute the underlined segment in the given sentence.  
No sooner did we reach at the party that it began to rain.

- Ans
- 1. it began to rain
  - 2. before it began to rain
  - 3. than it began to rain
  - 4. as it began to rain

Q.23 Select the most appropriate option that can substitute the underlined segment in the given sentence. If there is no need to substitute it, select 'No substitution required'.

I cannot use my office at the moment because it being painted.

- Ans
- 1. it is being painted
  - 2. it had been paint
  - 3. it has being painted
  - 4. No substitution required

Q.24 Select the most appropriate synonym of 'amazement' to fill the blank.  
Leena was filled with \_\_\_\_\_ when she saw the diamond ring as her wedding gift.

- Ans
- 1. happiness
  - 2. measurement
  - 3. haughtiness
  - 4. astonishment

Q.25 Select the most appropriate pair of words to fill in the blanks.  
Yesterday, he \_\_\_\_\_ pizza and \_\_\_\_\_ burgers in one go.

- Ans
- 1. eight; ate
  - 2. ate; ate
  - 3. eight; eight
  - 4. ate; eight

Q.1 Select the correct mirror image of the given figure when the mirror is placed at MN as shown below.

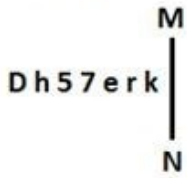

- Ans
- 1. Dh57erk
  - 2. k7e5rhd
  - 3. k7e5rhd
  - 4. Dh57erk

Q.2 What will come in the place of the question mark (?) in the following equation, if '+' and '-' are interchanged and '×' and '÷' are interchanged?

$$204 \times 6 - 6 \div 4 + 7 = ?$$

- Ans
- 1. 41
  - 2. 21
  - 3. 51
  - 4. 31

Q.3 14 is related to 43 by certain logic. Following the same logic, 17 is related to 52. To which of the following is 19 related, following the same logic?(NOTE: Operations should be performed on the whole numbers, without breaking down the numbers into its constituent digits. E.g. 13 – Operations on 13 such as adding/subtracting/multiplying etc. to 13 can be performed. Breaking down 13 into 1 and 3 and then performing mathematical operations on 1 and 3 is not allowed.)

- Ans
- 1. 57
  - 2. 50
  - 3. 38
  - 4. 58

Q.4 JHDC is related to KGEb in a certain way based on the English alphabetical order. In the same way, QOKJ is related to RNLI. To which of the following is USON related, following the same logic?

- Ans
- 1. VRPM
  - 2. VSQM
  - 3. VRQM
  - 4. VSPM

Q.5 If 'A' stands for '+', 'B' stands for '×', 'C' stands for '÷' and 'D' stands for '-', then the resultant of which of the following will be 100?

- Ans
- 1. 15 C 9 D 810 A 9 B 55
  - 2. 15 D 9 B 810 A 9 C 55
  - 3. 15 B 9 D 810 A 9 C 55
  - 4. 15 A 9 D 810 B 9 C 55

Q.6 Identify the figure given in the options which when put in place of the question mark (?) will logically complete the series?

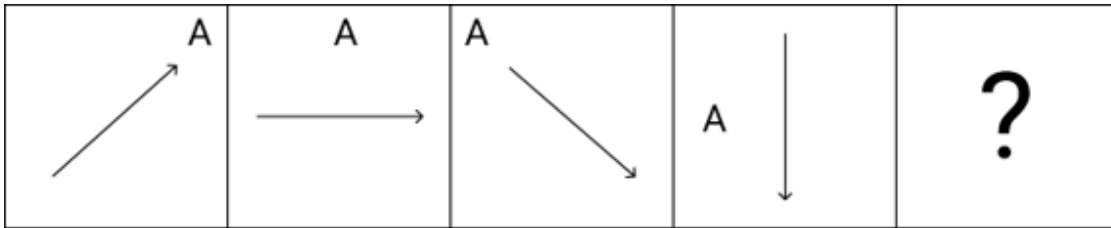

Ans

✗ 1.

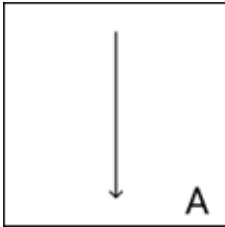

✗ 2.

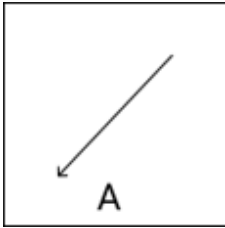

✓ 3.

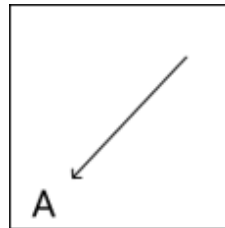

✗ 4.

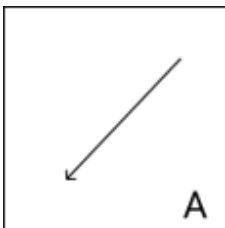

Q.7 If 24 July 1999 was Saturday, then what was the day of the week on 28 July 2003?

Ans ✓ 1. Monday

✗ 2. Saturday

✗ 3. Sunday

✗ 4. Tuesday

Q.8 Select the option figure in which the given figure is embedded as its part (rotation is NOT allowed).



Ans

1.

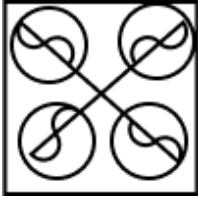

2.



3.

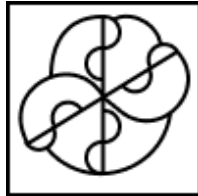

4.



Q.9 How many rectangles are there in the following figure?

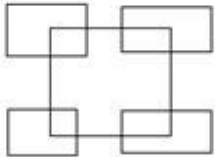

Ans  1. 10

2. 7

3. 9

4. 5

Q.10 Which of the following numbers will replace the question mark (?) in the given series?

214 111 179 126 144 141 109 156 ?

Ans  1. 96

2. 89

3. 61

4. 74

Q.11 What would be the number on the opposite side of '23' if the given sheet is folded to form a cube?

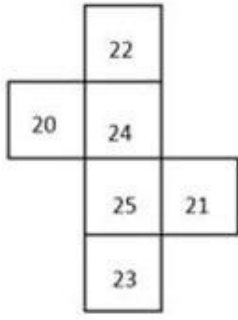

- Ans
- 1. 24
  - 2. 20
  - 3. 21
  - 4. 22

Adda247 Marathi

Q.12 Select the option in which the given figure X is embedded (rotation is NOT allowed).

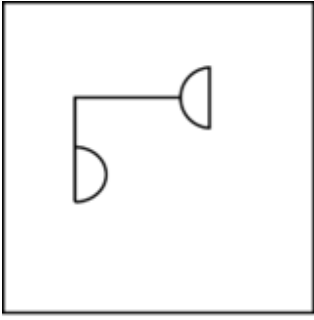

(X)

Ans

✗ 1.

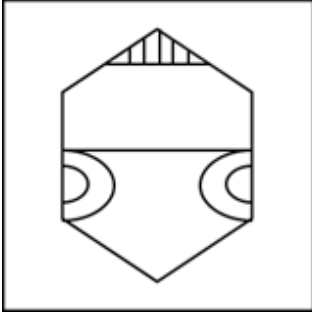

✗ 2.



✗ 3.

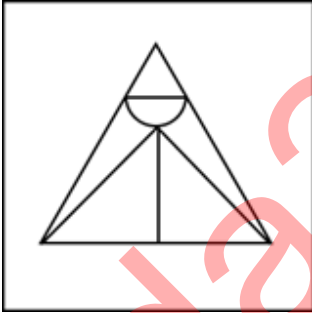

✓ 4.

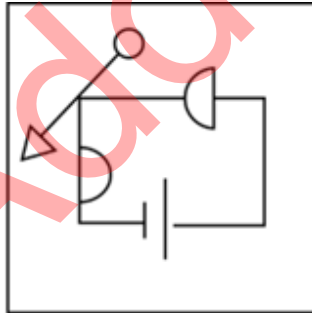

Q.13 Select the set in which the numbers are related in the same way as are the numbers of the following sets.  
(NOTE: Operations should be performed on the whole numbers, without breaking down the numbers into their constituent digits. E.g. 13 – Operations on 13 such as adding/subtracting/multiplying etc. to 13 can be performed. Breaking down 13 into 1 and 3 and then performing mathematical operations on 1 and 3 is not allowed.)  
(12, 4, 16)  
(27, 9, 36)

Ans ✗ 1. (39, 15, 52)

✗ 2. (39, 13, 54)

✗ 3. (37, 13, 52)

✓ 4. (39, 13, 52)



Q.14 If 'A' stands for '+', 'B' stands for '×', 'C' stands for '+' and 'D' stands for '−', what will come in place of the question mark (?) in the following equation?

$$62 \text{ B } 2 \text{ D } 190 \text{ A } 5 \text{ C } 7 = ?$$

- Ans
- 1. 90
  - 2. 91
  - 3. 93
  - 4. 92

Q.15 GJHK is related to IMKM in a certain way based on the English alphabetical order. In the same way, QTRU is related to SWUV. To which of the following is ILJM related, following the same logic?

- Ans
- 1. KOMO
  - 2. KNMN
  - 3. KMON
  - 4. KPNP

Q.16 Select the word-pair that best represents a similar relationship to the one expressed in the pair of words given below. (The words must be considered as meaningful English words and must not be related to each other based on the number of letters/number of consonants/vowels in the word.)  
Leaf : Oak

- Ans
- 1. Berry : Fruit
  - 2. Bulb : Tulip
  - 3. Needle : Pine
  - 4. Tree : Forest

Q.17 Select the correct option that when filled in the blanks in the same sequence will make the series logically complete.  
QUAI\_Q\_YIL\_U\_ILQUU\_L

- Ans
- 1. LWQUI
  - 2. LIQAU
  - 3. LUQWI
  - 4. LXIUQ

Q.18 What should come in place of the question mark (?) in the given series?

$$66, 77, 99, 132, 176, ?$$

- Ans
- 1. 232
  - 2. 230
  - 3. 233
  - 4. 231

Q.19 In a certain code language, 'BORN' is coded as '8234' and 'NORM' is coded as '6328'. How is 'M' coded in the given language?

- Ans
- 1. 8
  - 2. 2
  - 3. 4
  - 4. 6

Q.20 In this question, three statements are given, followed by three conclusions numbered I, II and III. Assuming the statements to be true, even if they seem to be at variance with commonly known facts, decide which of the conclusion(s) logically follows/follow from the statements.

Statements:

All ladders are chairs.

All chairs are tables.

No table is a stair.

Conclusions:

I. Some tables are ladders.

II. No chair is a stair.

III. Some ladders are stairs.

- Ans
- 1. Only conclusion II follows.
  - 2. Only conclusion III follows.
  - 3. Both conclusions I and II follow.
  - 4. Only conclusion I follows.

Q.21 Four letter-clusters have been given, out of which three are alike in some manner and one is different. Select the letter-cluster that is different.

(Note: The odd one out is not based on the number of consonants/vowels or their position in the letter cluster)

- Ans
- 1. MNOL
  - 2. AZCX
  - 3. PKRI
  - 4. PLRI

Q.22 In a certain language,

A & B means A is the wife of B,

A ÷ B means A is the daughter of B,

A × B means A is the son of B,

A + B means A is the sister of B and

A @ B means A is the father of B.

P & Q @ L + T & U @ V

Based on the above, how is Q related to V?

- Ans
- 1. Sister
  - 2. Mother
  - 3. Father's mother
  - 4. Mother's father

Q.23 What should come in place of the question mark (?) in the given series?

33, 61, 117, 229, ?

- Ans
- 1. 354
  - 2. 543
  - 3. 453
  - 4. 435

Q.24 In a certain code language, 'DZLV' is coded as 'HDJT' and 'CQYH' is coded as 'GUWF'. What is the code for 'MTBE' in the given code language?

- Ans
- 1. YAYB
  - 2. QZYB
  - 3. QXZC
  - 4. YZXB

Q.25

A square sheet of paper is folded along the dotted line successively along the directions shown and is then punched in the end. How would the paper look when unfolded?



Ans

- 1.
- 2.
- 3.
- 4.

Section : Quantitative Aptitude

1. The sum of two numbers is 76. Three times the larger number is 46 more than four times the smaller one. Find the two numbers.

- Ans
- 1. 35 and 41
  - 2. 40 and 36
  - 3. 44 and 32
  - 4. 50 and 26

Q.2 If the number  $6p5157q$  is divisible by 88, then  $p \times q = \underline{\hspace{2cm}}$ , where p and q are single digit numbers.

- Ans
- 1. 15
  - 2. 18
  - 3. 20
  - 4. 12

Q.3 A number increased by 20% gives 240. Find the number.

- Ans
- 1. 240
  - 2. 280
  - 3. 200
  - 4. 250

Q.4 PBA and PDC are two secants. AD is the diameter of the circle with the centre at O.  $\angle A = 30^\circ$ ,  $\angle P = 20^\circ$ . Find the measure of  $\angle DBC$ .

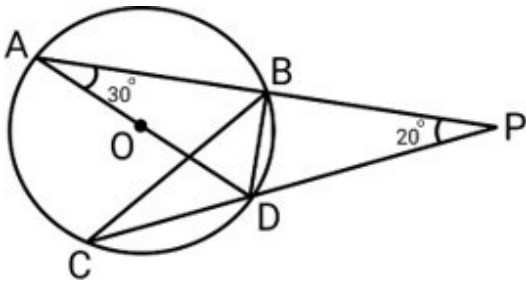

- Ans
- 1.  $50^\circ$
  - 2.  $30^\circ$
  - 3.  $45^\circ$
  - 4.  $40^\circ$

Q.5 The value of  $\left(\frac{\sin \theta}{1 + \cos \theta} + \frac{1 + \cos \theta}{\sin \theta}\right) \left(\frac{1}{\tan \theta + \cot \theta}\right)$  is equal to:

- Ans
- 1.  $\tan \theta$
  - 2. 1
  - 3.  $2 \cos \theta$
  - 4.  $2 \sin \theta$

Q.6 By selling an article for ₹2,160, Prashant allows a 20% discount and earns 28% profit. If the article is sold without any discount, the profit will be:

- Ans
- 1. 55%
  - 2. 60%
  - 3. 65%
  - 4. 50%

Q.7 The ratio of red to green sweets in a bag is 3 : 4. How many red sweets are there in the bag if the number of green sweets is 120?

- Ans
- 1. 100
  - 2. 80
  - 3. 70
  - 4. 90

Q.8 A solid metallic sphere of radius 6 cm is melted and recast into spherical balls of radius 3 cm. The number of spherical balls thus obtained is:

- Ans
- 1. 6
  - 2. 10
  - 3. 4
  - 4. 8

- Q.9 The following line graph shows the units manufactured by a company in some months. In which month did the company report the highest growth (in %) in production as compared with the respective previous month's production?

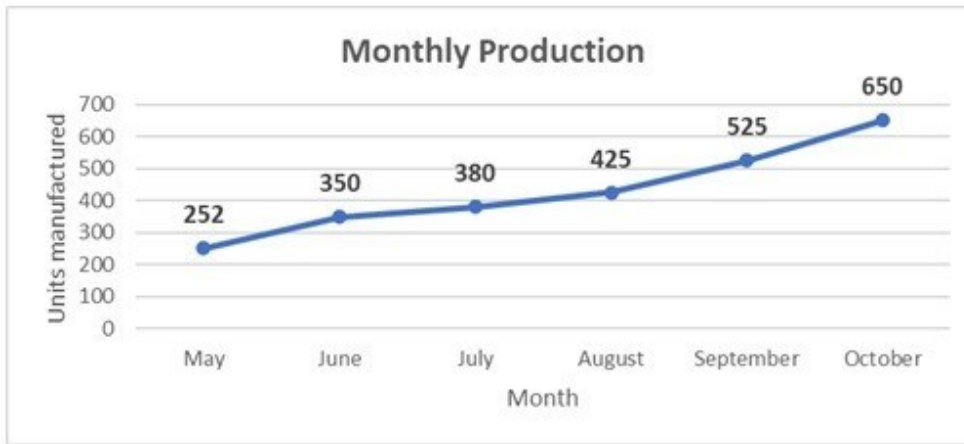

- Ans
- 1. July
  - 2. October
  - 3. June
  - 4. September

Q.10

What is the value of  $\frac{\left[\frac{1}{4} \div \frac{1}{4} \times \frac{1}{4}\right] \times \frac{1}{4}}{\left[\frac{1}{8} + \frac{1}{8} \times \frac{1}{8}\right]} + \left(1 - \frac{4}{9}\right)$ ?

- Ans
- 1. 2
  - 2. 0
  - 3. 3
  - 4. 1

Q.11 PQR is a triangle. MN is a line segment intersecting PQ in M and PR in N such that  $MN \parallel QR$  and divides  $\Delta PQR$  into two parts, which are equal in area. What is the ratio of MQ to PQ?

- Ans
- 1.  $\sqrt{2} : (\sqrt{2} - 1)$
  - 2.  $\sqrt{2} : 1$
  - 3.  $(\sqrt{2} - 1) : \sqrt{2}$
  - 4.  $1 : \sqrt{2}$

Q.12 Find the altitude (in cm) from the vertex Q to side PR of triangle PQR with side lengths  $PQ = 40$  cm,  $PR = 40$  cm and  $QR = 60$  cm.

- Ans
- 1.  $25\sqrt{7}$
  - 2.  $15\sqrt{7}$
  - 3.  $30\sqrt{7}$
  - 4.  $20\sqrt{7}$

Q.13

Study the given graph and answer the question that follows.

The graph shows the marks obtained by Riya and Rida in six subjects in the CBSE 12<sup>th</sup> exam. The maximum marks in Maths, Physics and Chemistry are 140, and that in English, IP and Biology are 180.

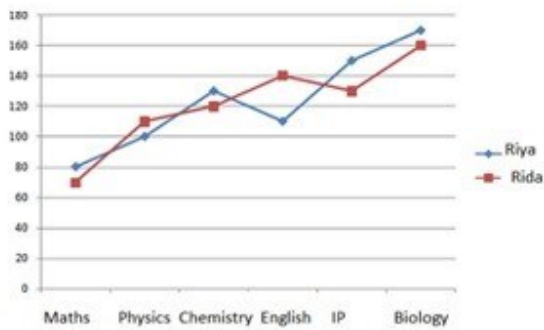

What is the difference between the percentage of marks obtained by Riya and Rida in IP?

Ans

- ✓ 1. 11.11%
- ✗ 2. 19%
- ✗ 3. 20%
- ✗ 4. 31%

Q.14

Nirmal completed the school project in 45 days. How many days will Amit take to complete the same work if he is 25% more efficient than Nirmal?

Ans

- ✓ 1. 36
- ✗ 2. 25
- ✗ 3. 38
- ✗ 4. 30

Q.15

A police travelling at 65 km/h is chasing a thief who is 1200 m away from him and is travelling at 41 km/h. Find the time taken by the policeman to catch the thief.

Ans

- ✗ 1. 1 min
- ✓ 2. 3 min
- ✗ 3. 2 min
- ✗ 4. 4 min

Q.16

A shopkeeper sells goods at 40% loss on cost price but uses 25% less weight. What is his percentage profit or loss?

Ans

- ✗ 1. Profit, 20%
- ✗ 2. Loss, 10%
- ✓ 3. Loss, 20%
- ✗ 4. Profit, 10%

Q.17

A laptop charger is sold for Rs.2,540 in cash or for a down payment of Rs.1,340 in cash together with Rs.1,205 to be paid after one month. Find the rate of interest charged in the instalment scheme.

Ans

- ✗ 1. 20% p.a.
- ✗ 2. 10% p.a.
- ✓ 3. 5% p.a.
- ✗ 4. 15% p.a.

Q.18 What is the area of a quadrilateral ABCD, (shown below) in which sides AB and BC are equal, sides AD and CD are of lengths 5 cm and 13 cm, respectively, and side AD is perpendicular to the diagonal AC?

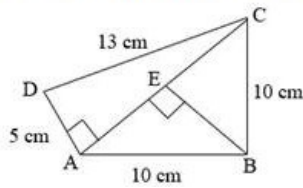

- Ans
- 1.  $75 \text{ cm}^2$
  - 2.  $78 \text{ cm}^2$
  - 3.  $82 \text{ cm}^2$
  - 4.  $80 \text{ cm}^2$

Q.19 The given table represents the percentage marks of three students in three subjects. Study the table and answer the question.

subject \ Student	Geography	History	Economics
Rohan	78	77	74
Sohan	84	80	82
Mohan	87	83	86

The average marks (to the nearest integer) obtained by the students in History and Economics (repectively) are:

- Ans
- 1. 80 and 81
  - 2. 81 and 80
  - 3. 78 and 80
  - 4. 80 and 78

Q.20 The following table shows the loan disbursed by four banks (in Crores) over four years:

Banks	2016	2017	2018	2019
A	10	15	20	22
B	5	10	15	18
C	20	25	15	20
D	5	10	25	20

In which year total disbursement of loans of banks A and B is exactly equal to the total disbursement of loans of banks C and D?

- Ans
- 1. 2017
  - 2. 2019
  - 3. 2016
  - 4. 2018

Q.21 The population of a village was 4,00,000. It increased by 20% in the first year and increased by 30% in the second year. Its population after two years is \_\_\_\_\_.

- Ans
- 1. 6,25,000
  - 2. 6,24,000
  - 3. 5,40,000
  - 4. 5,20,000

Q.22 Find the surface area (in  $\text{cm}^2$ ) of a cardboard box in the shape of a cuboid whose length is 60 cm, breadth is half its length and height is one-third of its breadth.

- Ans
- 1. 2700
  - 2. 5400
  - 3. 10800
  - 4. 8100

Q.23 The average age of Ruby and Soni is 40 years. The ratio of their ages is 11 : 5, respectively. What is the age (in years) of Soni?

- Ans
- 1. 15
  - 2. 30
  - 3. 55
  - 4. 25

Q.24 By what percentage should a racer increase the speed to reduce the time by 25% to cover a fixed distance?

- Ans
- 1. 31%
  - 2. 41%
  - 3.  $37\frac{1}{3}\%$
  - 4.  $33\frac{1}{3}\%$

Q.25 From a circle of radius  $r$  units, the largest equilateral triangle is cut out. What is the length (in units) of the side of the triangle?

- Ans
- 1.  $\sqrt{2}r$
  - 2.  $\frac{r}{\sqrt{3}}$
  - 3.  $\sqrt{3}r$
  - 4.  $\frac{r}{\sqrt{2}}$

Section : General Awareness

1. On 11 August 2021, the General Insurance Business (Nationalisation) Amendment Bill, 2021 was passed by the Parliament and it amended the \_\_\_\_\_.

- Ans
- 1. Life Insurance (Nationalisation) Act, 1975
  - 2. General Business (Nationalisation) Act, 1970
  - 3. Motor Insurance (Nationalisation) Act, 1980
  - 4. General Insurance Business (Nationalisation) Act, 1972



2. \_\_\_\_\_ was named as the new Shiv Sena president at the party national executive meeting in Mumbai in 2023.

- Ans
- 1. Eknath Shinde
  - 2. Narayan Rane
  - 3. Rahul Ramesh Shewale
  - 4. Aditya Uddhav Thackeray

3. The Parliament of India has passed the 86th Constitutional Amendment Act 2002, which establishes the basic rights of primary education for children between:

- Ans
- 1. 7-16 Years
  - 2. 5-11 years
  - 3. 6-14 Years
  - 4. 6-17 Years

Q.4 Which Commission drew the boundary line between India and Pakistan?

- Ans
- 1. Radcliffe Boundary Commission
  - 2. Gandhi Irwin Pact
  - 3. Hilton Young Commission
  - 4. Bretton woods Commission

Q.5 In which Gharana do singers perform the Khandhar Vani and Gauhar Vani?

- Ans
- 1. Talwandi Gharana
  - 2. Darbhanga Gharana
  - 3. Dagari Gharana
  - 4. Bettiah Gharana

Q.6 Delhi ridge is the water divide between which of the following rivers?

- Ans
- 1. Ganges and Yamuna
  - 2. Indus and Mahi
  - 3. Ganges and Indus
  - 4. Ganges and Sind

Q.7 The slide number can be added to each slide of the MS PowerPoint presentation from which of the following?

- Ans
- 1. Page Formatting
  - 2. View
  - 3. Footer
  - 4. Table Design

Q.8 Which of the following statements most accurately describes the Cyclostomata group?

- Ans
- 1. They are ectothermic animals having mucus glands in the skin, and a three-chambered heart.
  - 2. They are warm-blooded, oviparous, bipedal, feathered, winged and toothless vertebrates.
  - 3. They are characterised by having an elongated eel-like body, circular mouth, slimy skin and are scaleless.
  - 4. Their skin is covered with scales/plates and their hearts have only two chambers.

Q.9 What is/are the objective(s) of Fiscal Policy?

- 1) Boost growth
- 2) Control inflation

- Ans
- 1. Neither 1 nor 2
  - 2. Both 1 and 2
  - 3. Only 2
  - 4. Only 1

Q.10 The Fundamental Duties of Citizens were introduced by the 42nd Amendment in the year:

- Ans
- 1. 1978
  - 2. 1980
  - 3. 1976
  - 4. 1988

Q.11 In which year did Swami Vivekananda give his speech at the Chicago Parliament of Religions?

- Ans
- 1. 1892
  - 2. 1891
  - 3. 1890
  - 4. 1893

Q.12 Where did India win its last Olympic medal in men's hockey? (As of March, 2024).

- Ans
- 1. Tokyo
  - 2. Rio
  - 3. Munich
  - 4. Mexico City

Q.13 Which of the following statement/(s) is /are true with respect to Supreme Court Observation in A.G. Perarivalan vs The State Of Tamil Nadu State?

1. It highlighted that the Governor's powers are qualified by the constitutional mandate, chiefly requiring them to act in aid and advice of the council of ministers
2. The bench headed by justice L Nageswara Rao ordered the freedom of one of the convicts in the Rajiv Gandhi assassination case.
3. The bench was of the opinion that there are three sources of power-Governor, Council of Ministers and the Constitution.

- Ans
- 1. Only 1
  - 2. Both 1 and 2
  - 3. Only 3
  - 4. Both 2 and 3

Q.14 Which of the following is NOT the colour of a warning card in kabaddi?

- Ans
- 1. Black
  - 2. Red
  - 3. Green
  - 4. Yellow

Q.15 Articles 344 (1) and 351 of the Constitution of India are related to the:

- Ans
- 1. Third Schedule
  - 2. Sixth Schedule
  - 3. Fifth Schedule
  - 4. Eighth Schedule

Q.16 Which Mughal ruler was responsible for the execution of Guru Tegh Bahadur in the year 1675?

- Ans
- 1. Aurangzeb
  - 2. Shahjahan
  - 3. Akbar
  - 4. Jahangir

Q.17 Match the states in column A with their official languages in column B.

Column A (States)	Column B (Official Languages)
1. Andhra Pradesh	a. Malayalam
2. Kerala	b. Telugu
3. Karnataka	c. Konkani
4. Goa	d. Kannada

- Ans
- 1. 1-b, 2-a, 3-c, 4-d
  - 2. 1-b, 2-a, 3-d, 4-c
  - 3. 1-a, 2-b, 3-d, 4-c
  - 4. 1-a, 2-b, 3-c, 4-d

Q.18 Which of the following isotopes is used as a fuel in nuclear power plants for generating electricity?

- Ans
- 1. Uranium- 235
  - 2. Arsenic-74
  - 3. Carbon-14
  - 4. Sodium-24

Q.19 Most major sports awards are accompanied by a cash reward. Which of the following is the only national sports award that does NOT include a cash reward?

- Ans
- 1. Rashtriya Khel Protsahan Puruskar
  - 2. Major Dhyan Chand Khel Ratna
  - 3. Maulana Abul Kalam Azad Trophy
  - 4. Dronacharya Award

Q.20 Which Indian festival is a festival of lights?

- Ans
- 1. Holi
  - 2. Onam
  - 3. Bihu
  - 4. Diwali

Q.21 The famous folk music of Rajasthan that was developed in royal courts is known as:

- Ans
- 1. Dandiya
  - 2. Sohar
  - 3. Lavani
  - 4. Maand

Q.22 The Howrah bridge was officially opened in the year \_\_\_\_\_.

- Ans
- 1. 1943
  - 2. 1948
  - 3. 1930
  - 4. 1935

Q.23 Which of the following statements about planet Saturn is true?

- Ans
- 1. Satellites like Enceladus and Titan of Saturn are home to internal oceans, could possibly support life.
  - 2. Saturn is the fourth planet from the Sun and the largest planet in our solar system.
  - 3. Saturn's environment is conducive to life.
  - 4. Saturn is a massive ball made up mostly of nitrogen.

**Q.24** The Lucknow Gharana of Kathak was founded by \_\_\_\_\_, a devotee of the Bhakti movement who lived in southeast Uttar Pradesh.

- Ans**
- 1. Bhagwan Ram
  - 2. Ishwari Prasad
  - 3. Shyam Kumar
  - 4. Ram Kumar

**Q.25** In Microsoft Office, how is the font size determined?

- Ans**
- 1. Pixels
  - 2. Points
  - 3. Inches
  - 4. Centimetres

Adda247 Marathi

## Combined Higher Secondary Level Examination 2024 Tier I

Exam Date	11/07/2024
Exam Time	11:45 AM - 12:45 PM
Subject	CHSL Exam 2024 Tier I

### Section : English Language

1. The following sentence has been split into four segments. Identify the segment that contains a grammatical error. It is his job / to chase out / clients with / outstanding debts.

Ans  1. clients with  
 2. to chase out  
 3. outstanding debts  
 4. It is his job

2. Parts of the following sentence have been given as options. Select the option that contains an error. Mumbai is the city of dreams but it is a expensive city too.

Ans  1. a expensive city too  
 2. but it is  
 3. Mumbai is the  
 4. city of dreams

3. Select the most appropriate option to fill in the blanks.  
(Ø = No article)  
\_\_\_\_\_ road to Taj Mahal passes through \_\_\_\_\_ forest.

Ans  1. A; the  
 2. Ø; Ø  
 3. The; a  
 4. A; a

- Q.4 The given sentence is divided into four segments. Select the option that has the segment with a grammatical error. He do not / fear the / repercussions of / this decision.

Ans  1. repercussions of  
 2. this decision.  
 3. He do not  
 4. fear the

**Comprehension:**

In the following passage, some words have been deleted. Read the passage carefully and select the most appropriate option to fill in each blank.

When Prime Minister Narendra Modi announced that rupees with the denominations of 500/- and 1000/- would 1.\_\_\_\_\_ to be the legal tender from the 9th of November, the whole country was stunned. This decision caused a sensation in the whole country. Social media was flooded with messages and information. People started counting the cash they had 2.\_\_\_\_\_ for years legally or illegally. The main objective of this move was to curb black money, corruption and fake money menace. All the people but those who indulged in 3.\_\_\_\_\_ welcomed the move. The whole opposition shook hands against this move under one pretence or the other. They called this decision a 4.\_\_\_\_\_ law and wanted the government to roll it back. Severe criticisms were made to target the decision. The government also carried out 5.\_\_\_\_\_ attacks.

**SubQuestion No : 5****Q.5 Select the most appropriate option to fill in blank No. 1.**

- Ans
- 1. collaborate
  - 2. seize
  - 3. cease
  - 4. unify

**Comprehension:**

In the following passage, some words have been deleted. Read the passage carefully and select the most appropriate option to fill in each blank.

When Prime Minister Narendra Modi announced that rupees with the denominations of 500/- and 1000/- would 1.\_\_\_\_\_ to be the legal tender from the 9th of November, the whole country was stunned. This decision caused a sensation in the whole country. Social media was flooded with messages and information. People started counting the cash they had 2.\_\_\_\_\_ for years legally or illegally. The main objective of this move was to curb black money, corruption and fake money menace. All the people but those who indulged in 3.\_\_\_\_\_ welcomed the move. The whole opposition shook hands against this move under one pretence or the other. They called this decision a 4.\_\_\_\_\_ law and wanted the government to roll it back. Severe criticisms were made to target the decision. The government also carried out 5.\_\_\_\_\_ attacks.

**SubQuestion No : 6****Q.6 Select the most appropriate option to fill in blank No. 2.**

- Ans
- 1. dispersed
  - 2. distributed
  - 3. accumulated
  - 4. withdrawn

**Comprehension:**

In the following passage, some words have been deleted. Read the passage carefully and select the most appropriate option to fill in each blank.

When Prime Minister Narendra Modi announced that rupees with the denominations of 500/- and 1000/- would 1.\_\_\_\_\_ to be the legal tender from the 9th of November, the whole country was stunned. This decision caused a sensation in the whole country. Social media was flooded with messages and information. People started counting the cash they had 2.\_\_\_\_\_ for years legally or illegally. The main objective of this move was to curb black money, corruption and fake money menace. All the people but those who indulged in 3.\_\_\_\_\_ welcomed the move. The whole opposition shook hands against this move under one pretence or the other. They called this decision a 4.\_\_\_\_\_ law and wanted the government to roll it back. Severe criticisms were made to target the decision. The government also carried out 5.\_\_\_\_\_ attacks.

**SubQuestion No : 7****Q.7 Select the most appropriate option to fill in blank No. 3.**

- Ans
- 1. amalgamation
  - 2. indecision
  - 3. malpractices
  - 4. announcement

**Comprehension:**

In the following passage, some words have been deleted. Read the passage carefully and select the most appropriate option to fill in each blank.

When Prime Minister Narendra Modi announced that rupees with the denominations of 500/- and 1000/- would 1. \_\_\_\_\_ to be the legal tender from the 9th of November, the whole country was stunned. This decision caused a sensation in the whole country. Social media was flooded with messages and information. People started counting the cash they had 2. \_\_\_\_\_ for years legally or illegally. The main objective of this move was to curb black money, corruption and fake money menace. All the people but those who indulged in 3. \_\_\_\_\_ welcomed the move. The whole opposition shook hands against this move under one pretence or the other. They called this decision a 4. \_\_\_\_\_ law and wanted the government to roll it back. Severe criticisms were made to target the decision. The government also carried out 5. \_\_\_\_\_ attacks.

**SubQuestion No : 8**

**Q.8** Select the most appropriate option to fill in blank No. 4.

- Ans**
- 1. like
  - 2. draconian
  - 3. comprehensive
  - 4. fragile

**Comprehension:**

In the following passage, some words have been deleted. Read the passage carefully and select the most appropriate option to fill in each blank.

When Prime Minister Narendra Modi announced that rupees with the denominations of 500/- and 1000/- would 1. \_\_\_\_\_ to be the legal tender from the 9th of November, the whole country was stunned. This decision caused a sensation in the whole country. Social media was flooded with messages and information. People started counting the cash they had 2. \_\_\_\_\_ for years legally or illegally. The main objective of this move was to curb black money, corruption and fake money menace. All the people but those who indulged in 3. \_\_\_\_\_ welcomed the move. The whole opposition shook hands against this move under one pretence or the other. They called this decision a 4. \_\_\_\_\_ law and wanted the government to roll it back. Severe criticisms were made to target the decision. The government also carried out 5. \_\_\_\_\_ attacks.

**SubQuestion No : 9**

**Q.9** Select the most appropriate option to fill in blank No. 5.

- Ans**
- 1. ineffectual
  - 2. revengeful
  - 3. case
  - 4. example

**Q.10** Select the most appropriate idiom that can substitute the underlined word segment in the given sentence.  
I know Covid has made you terribly ill, but the good thing is that you have developed immunity against it for further infections.

- Ans**
- 1. the silver spoon
  - 2. the silver lining in the cloud
  - 3. being in the quicksilver
  - 4. crossing palms with silver

**Q.11** Select the INCORRECTLY spelt word.

- Ans**
- 1. Psychometric
  - 2. Concentrate
  - 3. Vindication
  - 4. Conglomerate

**Q.12** Select the most appropriate option that can substitute the underlined segment in the given sentence.  
At his wit's end, he decided to return to his parents as he was unable to cope up with the stress of adjusting at a new place.

- Ans**
- 1. Not knowing what to do
  - 2. Taking all notes
  - 3. After thinking
  - 4. Deciding after contemplation

Q.13 Select the most appropriate option that can substitute the underlined segment in the following sentence.  
He passed away in the year 1950 at 10 a.m. on 13 July.

- Ans
- 1. in the year 1950 at 10 a.m. on 13 July
  - 2. at 10 a.m. on 13 July in the year 1950
  - 3. on 13 July at 10 a.m. in the year 1950
  - 4. in the year 1950 on 13 July at 10 a.m.

Q.14 Select the most appropriate homophones to fill in the blanks.  
Her father \_\_\_\_\_ her to opt for a chemistry \_\_\_\_\_ in her final year.

- Ans
- 1. aloud; course
  - 2. aloud; coarse
  - 3. allowed; coarse
  - 4. allowed; course

Q.15 Select the most appropriate synonym of the given word.

Perilous

- Ans
- 1. Dangerous
  - 2. Ugly
  - 3. Bad
  - 4. Adverse

Q.16 Select the most appropriate homonym to fill in the blank.

Please \_\_\_\_\_ more sugar to the juice so that it becomes sweeter.

- Ans
- 1. ad
  - 2. add
  - 3. aide
  - 4. aid

Q.17 Select the most appropriate option that can substitute the underlined segment in the given sentence.  
The meeting closed with a vote of thanks.

- Ans
- 1. completed
  - 2. finished
  - 3. stopped
  - 4. concluded

Q.18 Select the most appropriate option that can substitute the underlined segment in the given sentence.

I was in Oman around two months.

- Ans
- 1. from
  - 2. for
  - 3. into
  - 4. since

Q.19 Select the correct collocation to complete the following sentence.

She suppressed a \_\_\_\_\_ urge to yawn.

- Ans
- 1. tough
  - 2. stout
  - 3. hard
  - 4. strong



Q.20 Select the most appropriate ANTONYM of the given word.  
Precarious

- Ans
- 1. Luminous
  - 2. Reliable
  - 3. Colossal
  - 4. Doubtful

Q.21 Select the most appropriate meaning of the given idiom.  
Out of the frying pan and into the fire

- Ans
- 1. Things getting intense by the hour
  - 2. Being a horrible cook
  - 3. Being with someone through good times as well as bad times
  - 4. Things going from bad to worse

Q.22 Select the most appropriate ANTONYM of the underlined word in the given sentence.  
The vendor said that the apples were of superior quality.

- Ans
- 1. Excellent
  - 2. Inferior
  - 3. Small
  - 4. Distasteful

Q.23 Select the most appropriate synonym of the given word.  
Advanced

- Ans
- 1. Foreign
  - 2. Progressive
  - 3. Discarded
  - 4. Elementary

Q.24 Select the most appropriate synonym of the underlined word.  
My grandmother is fond of giving homilies to all my friends who visit my place.

- Ans
- 1. Suggestions
  - 2. Sermons
  - 3. Alternatives
  - 4. Strictures

Q.25 Select the correctly spelt word.

- Ans
- 1. Immediately
  - 2. Immedeatly
  - 3. Imediately
  - 4. Immediatly

Section : General Intelligence

1. Select the letter-cluster from among the given options that can replace the question mark (?) in the following series.  
EFG, KLM, QRS, ?

- Ans
- 1. WXZ
  - 2. XYZ
  - 3. WXY
  - 4. UVW

Q.2 In a certain code language, '78623' is coded as 'TAKEN' and '32685' is coded as 'TOKEN'. What is the code for '5' in that language?

- Ans
- 1. E
  - 2. A
  - 3. O
  - 4. T

3. Three of the following four are alike in a certain way and thus form a group. Which is the one that does NOT belong to that group?

(Note: The odd one out is not based on the number of consonants/vowels or their position in the letter cluster.)

- Ans
- 1. QSV
  - 2. LNP
  - 3. BDG
  - 4. FHK

Q.4 Three statements are followed by conclusions numbered I, II. You have to consider these statements to be true, even if they seem to be at variance with commonly known facts. Decide which of the given conclusions logically follow/s from the given statement.

Statements:

Some tables are gates.

All mats are tables.

All plates are gates.

Conclusion (I): All gates are mats.

Conclusion (II): All tables are plates.

- Ans
- 1. Both conclusions (I) and (II) follow.
  - 2. Only conclusion (II) follows.
  - 3. Only conclusion (I) follows.
  - 4. Neither conclusion (I) nor (II) follows.

Q.5 Six numbers 1, 2, 4, 5, 7 and 9 are written on different faces of a dice. Two positions of this dice are shown in the figure. Which is the number on the face opposite to the face containing 9?

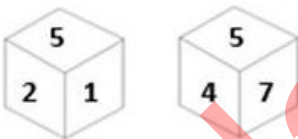

- Ans
- 1. 1
  - 2. 7
  - 3. 2
  - 4. 5

Q.6 If 'A' stands for '+', 'B' stands for '×', 'C' stands for '÷' and 'D' stands for '−', what will come in place of the question mark (?) in the following equation?

$$128 \text{ A } 4 \text{ C } 16 \text{ B } 7 \text{ D } 5 = ?$$

- Ans
- 1. 129
  - 2. 159
  - 3. 139
  - 4. 149

Q.7 In a certain code language, 'YOUR' is coded as '5627' and 'CROY' is coded as '2769'. What is the code for 'C' in the given code language?

- Ans
- 1. 9
  - 2. 2
  - 3. 6
  - 4. 7

Q.8 What will come in the place of the question mark (?) in the following equation, if '+' and '-' are interchanged and '×' and '÷' are interchanged?

$$10 - 12 \div 7 + 84 \times 21 = ?$$

- Ans
- 1. 95
  - 2. 85
  - 3. 93
  - 4. 90

Q.9 If 19 July 2000 is Wednesday, then what will be the day of the week on 14 June 2009?

- Ans
- 1. Friday
  - 2. Sunday
  - 3. Tuesday
  - 4. Thursday

Q.10 Six letters D, H, K, L, R and Y are written on different faces of a dice. Two positions of this dice are shown in the figure. Which is the letter on the face opposite to the face containing H?

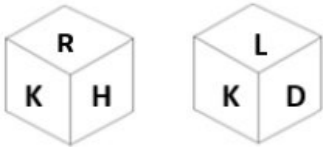

- Ans
- 1. K
  - 2. L
  - 3. D
  - 4. Y

Q.11 The sequence of folding a piece of paper and the manner in which the folded paper is punched is shown in the following figures. How would this paper look when unfolded?

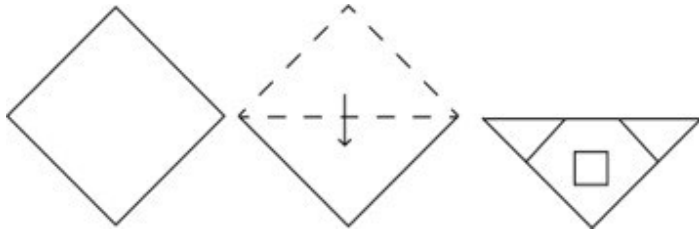

Ans

- ✓ 1.
- ✗ 2.
- ✗ 3.
- ✗ 4.

Adda247 Marathi

Q.12 A paper is folded and cut as shown below. How will it appear when unfolded?

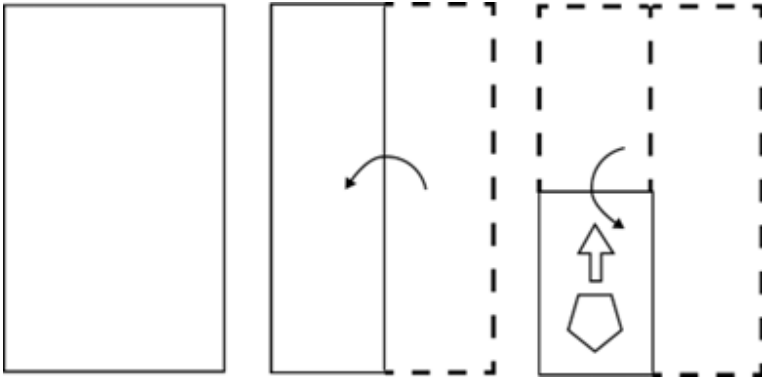

Ans

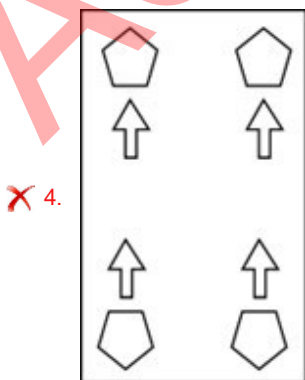
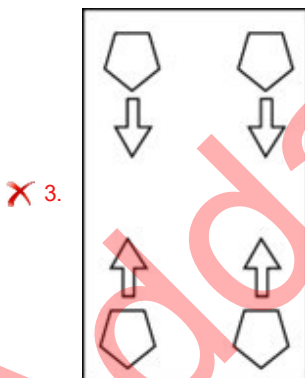
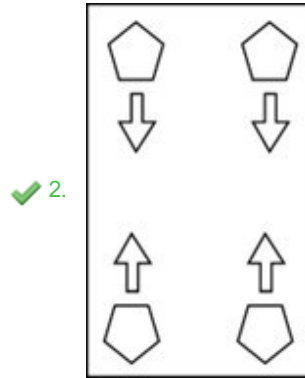
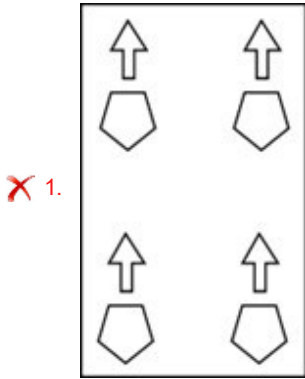

Q.13 What should come in place of ? in the given series based on the English alphabetical order?

RKD ? ZUP QMI HEB

- Ans
- 1. ZYZ
  - 2. ICW
  - 3. WCI
  - 4. ABC

Q.14 Select the set in which the numbers are related in the same way as are the numbers of the following sets.  
(NOTE : Operations should be performed on the whole numbers, without breaking down the numbers into its constituent digits. E.g. 13 – Operations on 13 such as adding /subtracting /multiplying etc. to 13 can be performed. Breaking down 13 into 1 and 3 and then performing mathematical operations on 1 and 3 is not allowed)  
(81, 53, 70)  
(94, 66, 83)

- Ans
- 1. (68, 40, 67)
  - 2. (77, 59, 76)
  - 3. (99, 71, 88)
  - 4. (86, 58, 65)

Q.15 Which of the following numbers will replace the question mark (?) in the given series?

19, ?, 43, 55, 67

- Ans
- 1. 33
  - 2. 34
  - 3. 31
  - 4. 41

Q.16 What will come in the place of the question mark (?) in the following equation, if '+' and '-' are interchanged and '-' and '×' are interchanged?

$$28 \div 90 + 6 - 5 \times 17 = ?$$

- Ans
- 1. 84
  - 2. 82
  - 3. 80
  - 4. 86

Q.17 What should come in place of ? in the given series?

131 141 161 191 231 ?

- Ans
- 1. 271
  - 2. 291
  - 3. 281
  - 4. 261

Q.18 38 is related to 80 following a certain logic. Following the same logic, 42 is related to 88. To which of the following is 29 related, following the same logic?

- Ans
- 1. 78
  - 2. 66
  - 3. 54
  - 4. 62

Q.19 If 2 August 2016 is a Tuesday, then what will the day of the week on 19 October 2020?

- Ans
- 1. Saturday
  - 2. Wednesday
  - 3. Monday
  - 4. Thursday

Q.20 Select the option that is embedded in the given figure (rotation is NOT allowed).

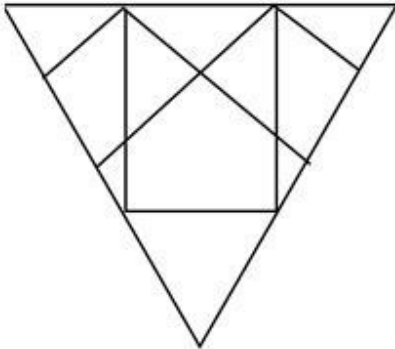

Ans

- 1.
- 2.
- 3.
- 4.

Q.21 In a certain code language,  
'M & N' means 'M is the wife of N',  
'M @ N' means 'M is the brother of N',  
'M \$ N' means 'M is the mother of N',  
'M # N' means 'M is the sister of N'.  
Based on this, how is Q related to U, if 'P & Q @ R \$ T # U'?

- Ans
- 1. Mother's brother
  - 2. Father
  - 3. Brother
  - 4. Father's brother

**Q.22** Select the pair which follows the same pattern as that followed by the two set of pairs given below. Both pairs follow the same pattern.

FJM : UQN

DPQ : WKJ

**Ans**  1. MNO : ONM

2. IEB : ACK

3. OVC : LEX

4. LHE : VUT

**Q.23** MAZQ is related to GUTK in a certain way based on the English alphabetical order. In the same way, CPNR is related to WJHL. To which of the following is KOEV related, following the same logic?

**Ans**  1. EYIP

2. EIYP

3. EYPI

4. EIPY

**Q.24** What is the maximum number of rectangles in the given figure?

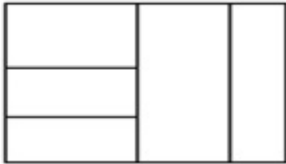

**Ans**  1. 12

2. 9

3. 8

4. 10



Q.25 Which figure should replace the question mark (?) if the following figure series were to be continued?

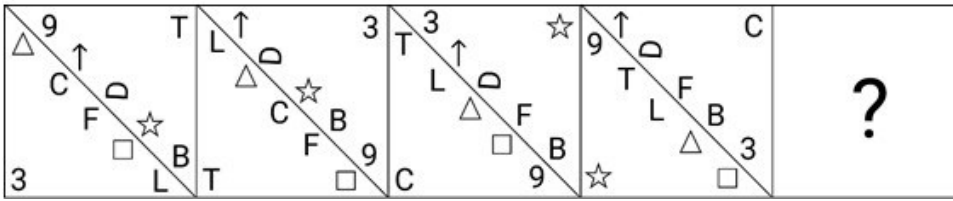

Ans

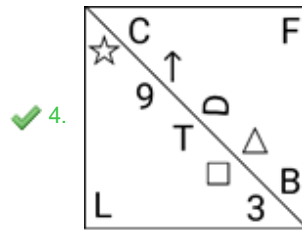
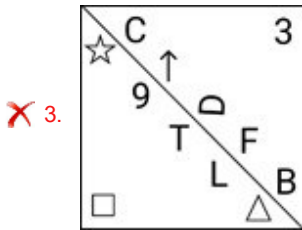
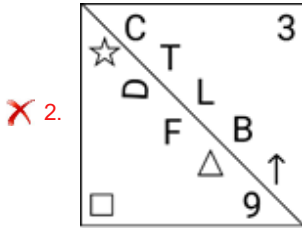
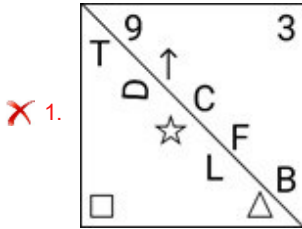

Section : Quantitative Aptitude

Q.1 The measure of each side of an equilateral triangle is 16 cm. What is the ratio of its perimeter to the sum of its medians?

Ans

✗ 1.  $\sqrt{3} : 2$

✗ 2.  $1 : 2\sqrt{3}$

✗ 3.  $2\sqrt{3} : 1$

✓ 4.  $2 : \sqrt{3}$

Q.2 Study the given pie-chart and answer the question that follows.

The pie-chart represents the total number of valid votes obtained by four students who contested for school leadership. The total number of valid votes polled was 720.

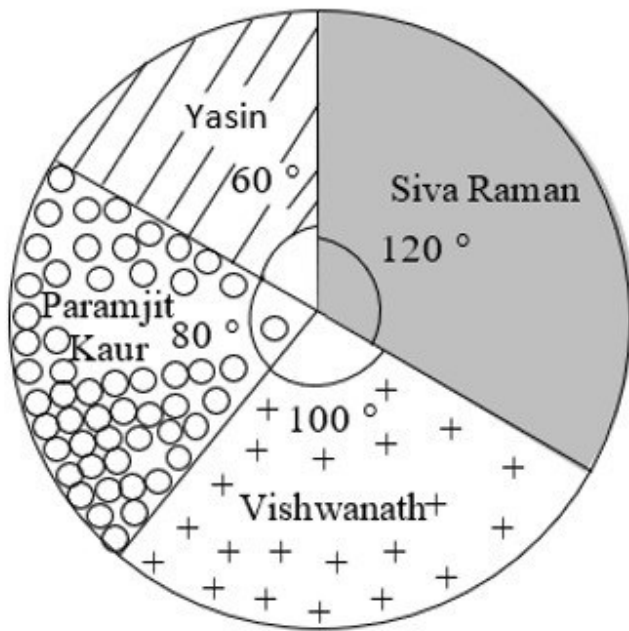

By how many votes did the winner defeat the nearest contestant?

- Ans
- 1. 30
  - 2. 40
  - 3. 20
  - 4. 10

Q.3 In an election, there were only two candidates. One of the candidates secured 44% of the votes and is defeated by the other candidate by 1440 votes. If there were no invalid votes, then the total number of votes polled is:

- Ans
- 1. 15000
  - 2. 12000
  - 3. 14000
  - 4. 13000

Q.4 Pomegranate juice contains 10% sugar solution and orange juice contains 30% sugar solution. What is the percentage of sugar solution in a mixture of two litres of pomegranate juice and three litres of orange juice?

- Ans
- 1. 22%
  - 2. 25%
  - 3. 20%
  - 4. 40%

Q.5 Three cubes each of side 5 cm are joined end to end. The surface area of the resulting cuboid is:

- Ans
- 1. 150 cm<sup>2</sup>
  - 2. 175 cm<sup>2</sup>
  - 3. 350 cm<sup>2</sup>
  - 4. 75 cm<sup>2</sup>

Q.6 A vertical pole of length 6 m casts a 4 m long shadow on the ground. At the same time, a tower casts a 28 m long shadow. Find the height of the tower.

- Ans
- 1. 42 m
  - 2. 32 m
  - 3. 36 m
  - 4. 48 m

Q.7 The sum of the digits of a two-digit number is 9. The number obtained by interchanging its digits exceeds the given number by 45, then the original number is:

- Ans
- 1. 18
  - 2. 27
  - 3. 36
  - 4. 54

Q.8 In  $\triangle DEW$ ,  $AB \parallel EW$ . If  $AD = 4$  cm,  $DE = 12$  cm and  $DW = 24$  cm, then find the length of  $DB$ .

- Ans
- 1. 7 cm
  - 2. 6 cm
  - 3. 9 cm
  - 4. 8 cm

Q.9 What is the value of  $\cos^{-1}\left(\frac{7}{25}\right) - \cos^{-1}\left(\frac{15}{17}\right)$ ?

- Ans
- 1.  $\sin^{-1}\left(\frac{304}{425}\right)$
  - 2.  $\cot^{-1}\left(\frac{297}{425}\right)$
  - 3.  $\tan^{-1}\left(\frac{297}{425}\right)$
  - 4.  $\cos^{-1}\left(\frac{304}{425}\right)$

Q.10 A hemispherical bowl is made of silver and has an inner diameter of 4 cm if the thickness of silver is 0.5 cm. Find the volume of silver used in making the bowl correct to two places of decimals (use  $\pi=3.14$ ).

- Ans
- 1. 15.96 cm<sup>3</sup>
  - 2. 51.96 cm<sup>3</sup>
  - 3. 15.69 cm<sup>3</sup>
  - 4. 51.69 cm<sup>3</sup>

Q.11 In an election between two candidates, 30% voters did not cast their votes and 200 votes were declared invalid. The winner got 65% of the valid votes. If he won by 1200 votes, then find the total votes.

- Ans
- 1. 9000
  - 2. 6000
  - 3. 7000
  - 4. 8000

Q.12 Which of the following is NOT true regarding a circle?

- Ans
- 1. The largest chord in a circle has a length twice its radius
  - 2. Given any three points in a plane, there is always a circle passing through these points
  - 3. The ratio of the perimeter and radius of a circle is always constant
  - 4. A triangle with vertices on a circle and one side as its diameter is a right-angled triangle

Q.13 A and B are two stations 420 km apart. A train starts from A at 11 am and travels towards B at the speed of 70 kmph. Another train starts from B at 12 noon and travels towards A at the speed of 30 kmph. At what time do they meet?

- Ans
- 1. 2 pm
  - 2. 1.30 pm
  - 3. 3.30 pm
  - 4. 3 pm

Q.14 Mira can complete a piece of work in 20 days, Nina in 30 days and Sima in 40 days. Mira and Sima worked together for 4 days and then Mira was replaced by Nina. In how many days, altogether, was the work completed?

- Ans
- 1. 14
  - 2. 18
  - 3. 16
  - 4. 20

Q.15 Divide 25 into two parts such that 6 times of the larger part added to 4 times of the smaller part is equal to 130. Find larger part.

- Ans
- 1. 20
  - 2. 14
  - 3. 13
  - 4. 15

Q.16 Study the given table and answer the question that follows.

The table shows the results of half-yearly and annual examinations of three sections A, B, C of class X students in a school.

Result	Number of students		
	Section A	Section B	Section C
Students failed in both exams	39	20	12
Students failed in half-yearly but passed in annual exams	16	14	6
Students passed in half-yearly but failed in annual exams	10	12	8
Students passed in both exams	65	45	35

Find the pass percentage of section A in at least one of the two examinations.

- Ans
- 1. 80%
  - 2. 65%
  - 3. 75%
  - 4. 70%

Q.17 On dividing a certain number by 459, we get 19 as remainder. What will be the remainder, when the same number is divided by 17?

- Ans
- 1. 13
  - 2. 2
  - 3. 11
  - 4. 1

Q.18 What is the value of a so that the seven-digit number 4645a52 is divisible by 72?

- Ans
- 1. 3
  - 2. 2
  - 3. 0
  - 4. 1

Q.19 The following table shows the number of trees axed in 2016 - 2020. Study the given information carefully and answer the question that follows.

Year	Neem	Banyan	Teak
2016	15,000	20,000	25,000
2017	18,000	28,000	28,000
2018	22,000	32,000	32,000
2019	25,000	35,000	35,000
2020	28,000	38,000	38,000

What was the percentage increase in the number of banyan trees axed in 2020 compared to the number of banyan trees axed in 2016?

- Ans
- 1. 60%
  - 2. 90%
  - 3. 47.4%
  - 4. 9%

Q.20 Shyam's income is 20% less than Ram's. How much is Ram's income more than Shyam's in percentage terms?

- Ans
- 1. 80%
  - 2. 30%
  - 3. 25%
  - 4. 20%

Q.21 A sum of ₹5,000 was lent to two people, one at the rate of 16% and the other at the rate of 24%. If the simple interest after one year is ₹960, what is the sum lent at the higher rate?

- Ans
- 1. ₹1,500
  - 2. ₹3,000
  - 3. ₹2,500
  - 4. ₹2,000

Q.22 A shopkeeper sells his goods using weights 27% less than true weights and claims to sell his goods at the cost price. His gain per cent (rounded off to 1 decimal place) is:

- Ans
- 1. 47.9
  - 2. 37.0
  - 3. 39.8
  - 4. 40.0

Q.23 O is the centre of the circle. Its two chord AB and CD intersect each other at the point P (internally) within the circle. If  $AP = 22$  cm,  $BP = 14$  cm,  $CP = 8$  cm, then find the value of the PD.

- Ans
- 1. 14 cm
  - 2. 11 cm
  - 3. 22 cm
  - 4. 12 cm

Q.24 Study the given graph and answer the question that follows.

The graph shows the profit percentage earned by two companies – A and B over a period of six years.



What is the percentage increase in profit percentage of company B in the year 2014 from the previous year?

- Ans
- 1. 13.63%
  - 2. 7.5%
  - 3. 5.75%
  - 4. 6.55%

Q.25 If the area of a rhombus is  $70 \text{ m}^2$  and its height is 5 m, its perimeter is \_\_\_\_\_.

- Ans
- 1. 56 m
  - 2. 35 m
  - 3. 64 m
  - 4. 25 m

1. To which Hindustani music Gharana are the Gundecha brothers related?

Ans 1.  Dagar Gharana

2. Agra Gharana

3. Patiala Gharana

4. Indore Gharana

2. When and where did the first Asian Games take place?

Ans 1.  1951, New Delhi

2. 1982, Punjab

3. 2014, Maharashtra

4. 2010, New Delhi

3. The Battle of Khanua was fought between Babur and \_\_\_\_\_.

Ans 1.  Medini Rao

2. Maharana Pratap

3. Rana Ratna Singh

4. Rana Sanga

Q.4 Which of the following pairs of Indian rivers is west flowing?

Ans  1. Mahanadi and Godavari

2. Krishna and Kaveri

3. Mahanadi and Krishna

4. Narmada and Tapi

Q.5 Any citizen of India can make a declaration renouncing his/her Indian citizenship under the \_\_\_\_\_.

Ans  1. Citizenship Act, 1975

2. Citizenship Act, 1985

3. Citizenship Act, 1955

4. Citizenship Act, 1965

Q.6 El Nino is a climate pattern that describes the unusual warming of surface waters in which ocean?

Ans  1. Indian Ocean

2. Atlantic Ocean

3. Arctic Ocean

4. Pacific Ocean

Q.7 With reference to Chethiagiri Vihar festival consider the following statements and select the correct option.

i) It is a Buddhist festival.

ii) It is held at Sanchi, Madhya Pradesh.

iii) Relics of SariPutta and Maha Moggallana are worshiped.

Ans  1. Both i and iii

2. Both ii and iii

3. Both i and ii

4. i, ii, iii

Q.8 Formulas in MS-Excel always start with which of the following symbols?

- Ans
- 1. ==
  - 2. -
  - 3. !
  - 4. =

Q.9 In August 2021, the Administrator of Lakshadweep, Praful Khoda Patel, highlighted that \_\_\_\_\_ style water villas, a project which is a first of its kind, will soon be set up in Lakshadweep, at a cost of 800 crores, in a bid to attract tourists to scenic beauty of the Union Territory.

- Ans
- 1. Mexico
  - 2. Maldives
  - 3. Fiji
  - 4. Malaysia

Q.10 In which year did a trio of scientists, Avery, MacLeod and McCarty, prove that except viruses, all living organisms have DNA as their genetic material?

- Ans
- 1. 1918
  - 2. 1902
  - 3. 1944
  - 4. 1961

Q.11 Which of the following statements is/are correct?

- I. Radio broadcasting started in India in 1923 by the Radio Club of Bombay.
- II. All India Radio came into being in 1936.
- III - In 1976, TV was delinked from All India Radio (AIR) and got a separate identity as Door darshan (DD).

- Ans
- 1. I, II and III are correct
  - 2. Both I and II are correct.
  - 3. Both II and III are correct.
  - 4. Only III is correct.

Q.12 In which year was the Rajiv Gandhi Khel Ratna award renamed as Major Dhyani Chand Khel Ratna award, which is the highest sporting honour in the nation?

- Ans
- 1. 2014
  - 2. 2021
  - 3. 1991
  - 4. 2019

Q.13 Which of these is NOT true of the second phase of the green revolution?

- Ans
- 1. It was adopted by farmers living in dry and semi-arid regions of India.
  - 2. It covered the period of the 1980s.
  - 3. It covered the period of the 1960s and 1970s.
  - 4. It was launched in areas with a significant shift from dry to wet (irrigated) cultivation.

Q.14 Where was the first Durand Cup, India's oldest football tournament, held?

- Ans
- 1. Madras
  - 2. Shimla
  - 3. Calcutta
  - 4. Delhi



Q.15 The UIDAI is under the jurisdiction of which of the following ministries?

- Ans
- 1. Ministry of Finance
  - 2. Ministry of Electronics and Information Technology
  - 3. Ministry of Home Affairs
  - 4. Ministry of Education

Q.16 In which year was Micro Units Development and Refinance Agency (MUDRA) introduced?

- Ans
- 1. 2017
  - 2. 2013
  - 3. 2009
  - 4. 2015

Q.17 Which shortcut key is used to paste a slide in Microsoft PowerPoint?

- Ans
- 1. CTRL + C
  - 2. CTRL + P
  - 3. CTRL + V
  - 4. CTRL + X

Q.18 In the Hindustani music system, the \_\_\_\_\_ are allotted to different hours of the day and different seasons.

- Ans
- 1. gita
  - 2. varnas
  - 3. srutis
  - 4. ragas

Q.19 Which organisation was started in the Pune district of Maharashtra in the 1870s with the aim of promoting education and social rights among the underprivileged group of the society?

- Ans
- 1. Satyashodhak Samaj
  - 2. Deepalaya Samaj
  - 3. Shoshit Seva Samaj
  - 4. Prarthana Samaj

Q.20 Match the dances in column A with their states in column B.

Column A  
(Dances)

1. Bharatanatyam
2. Mohiniattam
3. Garba
4. Sattriya

Column B  
(States)

- a. Gujarat
- b. Tamil Nadu
- c. Kerala
- d. Assam

- Ans
- 1. 1-c, 2-b, 3-a, 4-d
  - 2. 1-a, 2-c, 3-b, 4-d
  - 3. 1-b, 2-c, 3-d, 4-a
  - 4. 1-b, 2-c, 3-a, 4-d

Q.21 Who proposed that 'Light is made up of waves propagating perpendicular to the direction of its movement'?

- Ans
- 1. Newton
  - 2. Huygens
  - 3. Kepler
  - 4. Pauli

Q.22 Balasaraswati who was regarded as child prodigy by Vidhwans and Pandits played an important role in reviving the dance form \_\_\_\_\_.

- Ans
- 1. Kuchipudi
  - 2. Mohiniyattam
  - 3. Bharatanatyam
  - 4. Kathak

Q.23 Which of the following statements about the Mahila Samman Savings Certificate is incorrect as of 31 March 2024?

- Ans
- 1. The tenure of the scheme is 5 years.
  - 2. The scheme is valid up to 31 March 2025.
  - 3. The scheme was announced in the 2023-24 budget.
  - 4. The maximum limit of deposit in the scheme is 2 lakhs per year.

Q.24 As per the Economic Survey 2022-23, the Labour Force Participation Rate for males has gone up to \_\_\_\_\_ in 2020-21.

- Ans
- 1. 55.1%
  - 2. 59.3%
  - 3. 54.2%
  - 4. 57.5%

Q.25 The Indian Constitution borrowed the concept of concurrent list from \_\_\_\_\_.

- Ans
- 1. Australia
  - 2. Germany
  - 3. USSR
  - 4. Japan

## Combined Higher Secondary Level Examination 2024 Tier I

Exam Date	11/07/2024
Exam Time	2:30 PM - 3:30 PM
Subject	CHSL Exam 2024 Tier I

### Section : English Language

1. Identify the error in the tense of the sentence and select the option that correctly rectifies the error. Between two evils, I always picks the one I have never tried before.

Ans  1. Between two evils, I always pick the one I have never tried before.  
 2. Between two evils, I always is picking the one I have never tried before.  
 3. Between two evils, I always picked the one I have never tried before.  
 4. Between two evils, I always picking the one I have never tried before.

2. The following sentence has been split into four segments. Identify the segment that contains a grammatical error.

The teacher will / certainly help you / if you will / ask her.

Ans  1. certainly help you  
 2. The teacher will  
 3. if you will  
 4. ask her

3. The following sentence has been divided into three segments. Identify the segment that contains a grammatical error. If you don't find any error, select 'No error' as your answer. It was possible to achieve anything, / if one has the grit and determination / to keep going.

Ans  1. No error  
 2. It was possible to achieve anything,  
 3. if one has the grit and determination  
 4. to keep going.

- Q.4 The following sentence has been divided into four segments. Identify the segment that contains a grammatical error.

My Vice-Chancellor works / eighteen hours / a day, / seven days week.

Ans  1. seven days week.  
 2. My Vice-Chancellor works  
 3. eighteen hours  
 4. a day,

**Comprehension:**

In the following passage, some words have been deleted. Read the passage carefully and select the most appropriate option to fill in each blank.

Organic agriculture offers a means to substitute costlier agricultural inputs such as HYV seeds, chemical fertilisers and pesticides with locally produced organic inputs that are cheaper and thereby generate good returns on \_\_\_\_1\_\_\_\_. Organic agriculture also generates income through exports as the demand for organically grown crops is on a \_\_\_\_2\_\_\_\_. Studies across countries have shown that organically grown food has more nutritional value than chemical farming, thus providing us with healthy foods. Since organic farming requires more labour input than \_\_\_\_3\_\_\_\_ farming, India will find organic farming an attractive \_\_\_\_4\_\_\_\_. Finally, the produce is pesticide-free and produced in an environmentally \_\_\_\_5\_\_\_\_ way.

**SubQuestion No : 5****Q.5** Select the most appropriate option to fill in blank number 1.

- Ans**
- 1. loss
  - 2. profit
  - 3. expenditure
  - 4. investment

**Comprehension:**

In the following passage, some words have been deleted. Read the passage carefully and select the most appropriate option to fill in each blank.

Organic agriculture offers a means to substitute costlier agricultural inputs such as HYV seeds, chemical fertilisers and pesticides with locally produced organic inputs that are cheaper and thereby generate good returns on \_\_\_\_1\_\_\_\_. Organic agriculture also generates income through exports as the demand for organically grown crops is on a \_\_\_\_2\_\_\_\_. Studies across countries have shown that organically grown food has more nutritional value than chemical farming, thus providing us with healthy foods. Since organic farming requires more labour input than \_\_\_\_3\_\_\_\_ farming, India will find organic farming an attractive \_\_\_\_4\_\_\_\_. Finally, the produce is pesticide-free and produced in an environmentally \_\_\_\_5\_\_\_\_ way.

**SubQuestion No : 6****Q.6** Select the most appropriate option to fill in blank number 2.

- Ans**
- 1. decline
  - 2. rise
  - 3. growth
  - 4. stagnation

**Comprehension:**

In the following passage, some words have been deleted. Read the passage carefully and select the most appropriate option to fill in each blank.

Organic agriculture offers a means to substitute costlier agricultural inputs such as HYV seeds, chemical fertilisers and pesticides with locally produced organic inputs that are cheaper and thereby generate good returns on \_\_\_\_1\_\_\_\_. Organic agriculture also generates income through exports as the demand for organically grown crops is on a \_\_\_\_2\_\_\_\_. Studies across countries have shown that organically grown food has more nutritional value than chemical farming, thus providing us with healthy foods. Since organic farming requires more labour input than \_\_\_\_3\_\_\_\_ farming, India will find organic farming an attractive \_\_\_\_4\_\_\_\_. Finally, the produce is pesticide-free and produced in an environmentally \_\_\_\_5\_\_\_\_ way.

**SubQuestion No : 7****Q.7** Select the most appropriate option to fill in blank number 3.

- Ans**
- 1. insipid
  - 2. mechanical
  - 3. rigorous
  - 4. conventional

**Comprehension:**

In the following passage, some words have been deleted. Read the passage carefully and select the most appropriate option to fill in each blank.

Organic agriculture offers a means to substitute costlier agricultural inputs such as HYV seeds, chemical fertilisers and pesticides with locally produced organic inputs that are cheaper and thereby generate good returns on \_\_\_\_1\_\_\_\_. Organic agriculture also generates income through exports as the demand for organically grown crops is on a \_\_\_\_2\_\_\_\_. Studies across countries have shown that organically grown food has more nutritional value than chemical farming, thus providing us with healthy foods. Since organic farming requires more labour input than \_\_\_\_3\_\_\_\_ farming, India will find organic farming an attractive \_\_\_\_4\_\_\_\_. Finally, the produce is pesticide-free and produced in an environmentally \_\_\_\_5\_\_\_\_ way.

**SubQuestion No : 8****Q.8 Select the most appropriate option to fill in blank number 4.**

- Ans
- 1. obstacle
  - 2. proposition
  - 3. burden
  - 4. challenge

**Comprehension:**

In the following passage, some words have been deleted. Read the passage carefully and select the most appropriate option to fill in each blank.

Organic agriculture offers a means to substitute costlier agricultural inputs such as HYV seeds, chemical fertilisers and pesticides with locally produced organic inputs that are cheaper and thereby generate good returns on \_\_\_\_1\_\_\_\_. Organic agriculture also generates income through exports as the demand for organically grown crops is on a \_\_\_\_2\_\_\_\_. Studies across countries have shown that organically grown food has more nutritional value than chemical farming, thus providing us with healthy foods. Since organic farming requires more labour input than \_\_\_\_3\_\_\_\_ farming, India will find organic farming an attractive \_\_\_\_4\_\_\_\_. Finally, the produce is pesticide-free and produced in an environmentally \_\_\_\_5\_\_\_\_ way.

**SubQuestion No : 9****Q.9 Select the most appropriate option to fill in blank number 5.**

- Ans
- 1. sustainable
  - 2. innovative
  - 3. destructive
  - 4. harmful

**Q.10 Select the option that will improve the underlined part of the given sentence.  
Neither Janki or I am to receive the award.**

- Ans
- 1. either
  - 2. no
  - 3. nor
  - 4. not

**Q.11 Select the most appropriate option that can substitute the underlined segment in the given sentence. If there is no need to substitute it, select 'No substitution required'.**

The film was made in Botswana, whose wildlife parks is larger to those in Kenya.

- Ans
- 1. are larger than
  - 2. are large than
  - 3. No substitution required
  - 4. as large than

**Q.12 Select the most appropriate homophones to fill in the blanks.  
It was against her \_\_\_\_\_ to earn more \_\_\_\_\_ than that decided by the board of directors.**

- Ans
- 1. principle, profit
  - 2. principal; profit
  - 3. principal; prophet
  - 4. principle; prophet

Q.13 Select the most appropriate homophones to fill in the blanks.  
I \_\_\_\_\_ that he has been promoted to the post of \_\_\_\_\_ officer.

- Ans
- 1. herd; sealing
  - 2. heard; sealing
  - 3. herd; ceiling
  - 4. heard; ceiling

Q.14 Select the most appropriate meaning of the given idiom.  
To throw dust in one's eyes

- Ans
- 1. To talk in an abusive language
  - 2. To mislead someone by tricks
  - 3. To make someone blind forever
  - 4. To hit someone with stone

Q.15 Select the most appropriate ANTONYM of the given word.  
Queer

- Ans
- 1. Doubtful
  - 2. Fantastic
  - 3. Eccentric
  - 4. Ordinary

Q.16 Select the correctly spelt word.

- Ans
- 1. Quintessential
  - 2. Quintessintial
  - 3. Quintesential
  - 4. Quientessential

Q.17 Select the most appropriate option to fill in the blank and complete the sentence.  
You just wait in the lobby. I will be back after \_\_\_\_\_.

- Ans
- 1. a fast meal
  - 2. a quick shower
  - 3. a fast shower
  - 4. a quick food

Q.18 Select the most appropriate synonym of the given word.  
Anxiety

- Ans
- 1. Serenity
  - 2. Distress
  - 3. Dilemma
  - 4. Ease

Q.19 Select the most appropriate ANTONYM of the word 'Contaminate' from the given sentence.

Crews were requested to purify the system since a brain-eating amoeba was discovered in the drinking water.

- Ans
- 1. requested
  - 2. discovered
  - 3. purify
  - 4. system

Q.20 Select the most appropriate option to fill in the blank.  
The guard did not want anything bad to happen, so he ordered the group to step back to avoid anything \_\_\_\_\_.

- Ans
- 1. customary
  - 2. terrible
  - 3. habitual
  - 4. diplomatic

Q.21 Rectify the sentence by selecting the correct spelling from the options.

Psychology developed as a significant discipline of study in the twentieth century.

- Ans
- 1. Pscycology
  - 2. Psychology
  - 3. Pcychology
  - 4. Pscichology

Q.22 Select the most appropriate meaning of the underlined idiom in the given sentence.  
Every piece of furniture in her house is in apple-pie order.

- Ans
- 1. Very neatly arranged
  - 2. Painted in light colours
  - 3. Very delicately arranged
  - 4. Kept in a disorganised way

Q.23 Select the most appropriate option that can substitute the underlined segment in the given sentence.

He has recovered now and is feeling too strong to walk.

- Ans
- 1. too weak to walk
  - 2. weak enough to walk
  - 3. strong to walk
  - 4. strong enough to walk

Q.24 Select the most appropriate option that can substitute the underlined segment in the given sentence.  
Peter was the last to know that she had been cheating of him.

- Ans
- 1. cheating up him
  - 2. cheating in him
  - 3. cheat of him
  - 4. cheating on him

Q.25 Select the most appropriate ANTONYM of the underlined word.  
I left the job because of a hostile working environment.

- Ans
- 1. Morose
  - 2. Friendly
  - 3. Rustic
  - 4. Violent

Q.1 Select the word-pair that best represents a similar relationship to the one expressed in the pair of words given below.

(The words must be considered as meaningful English words and must not be related to each other based on the number of letters/number of consonants/vowels in the word)

Compress : Expand

- Ans
- 1. Hopeful : Optimistic
  - 2. Observe : Notice
  - 3. Limit : Boundless
  - 4. Defend : Protect

Q.2 If 'A' stands for '+', 'B' stands for '×', 'C' stands for '÷' and 'D' stands for '-', what will come in place of the question mark (?) in the following equation?

5 B 5 C 216 A 9 D 3 = ?

- Ans
- 1. 64
  - 2. 46
  - 3. 23
  - 4. 32

Q.3 Identify the figure in the options that when put in place of the question mark (?) will logically complete the series?

$\begin{array}{r} 10 \\ \times \\ 5 \\ \hline 15 \end{array}$	$\begin{array}{r} 15 \\ \times \\ 10 \\ \hline 25 \end{array}$	$\begin{array}{r} 20 \\ \times \\ 15 \\ \hline 35 \end{array}$	$\begin{array}{r} 25 \\ \times \\ 20 \\ \hline 45 \end{array}$	?
---	--	--	--	---

Ans

1.

$$\begin{array}{r} 30 \\ \times \\ 20 \\ \hline 10 \end{array}$$

2.

$$\begin{array}{r} 30 \\ \times \\ 25 \\ \hline 5 \end{array}$$

3.

$$\begin{array}{r} 30 \\ \times \\ 20 \\ \hline 50 \end{array}$$

4.

$$\begin{array}{r} 30 \\ \times \\ 25 \\ \hline 55 \end{array}$$



Q.4 A square sheet of paper is folded along the dotted line successively along the directions shown and is then punched in the last. How would the paper look when unfolded?

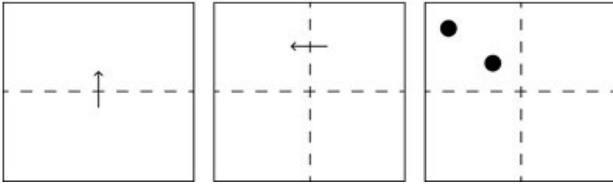

Ans

1.

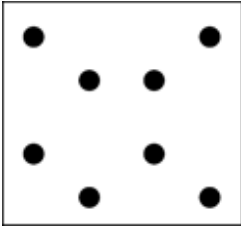

2.

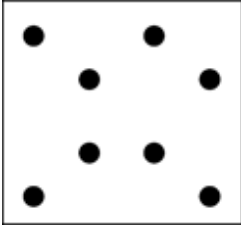

3.

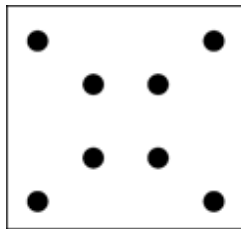

4.

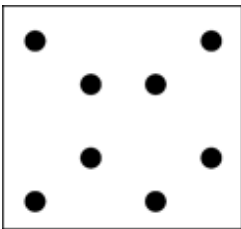

Q.5 The position of how many letters will remain unchanged if each of the letters in the word NUCLEAR is arranged in the alphabetical order?

Ans  1. None

2. One

3. Two

4. Three

Q.6 Select the correct mirror image of the given figure when the mirror is placed at MN, as shown.

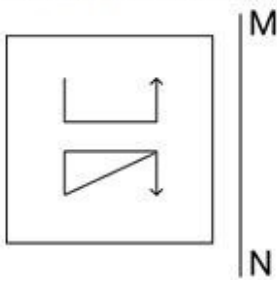

Ans

✗ 1.

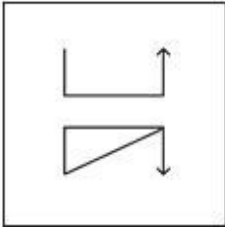

✓ 2.

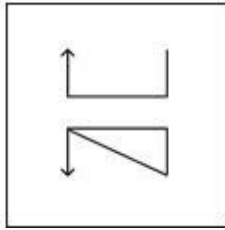

✗ 3.

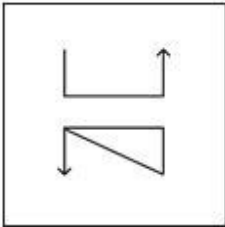

✗ 4.

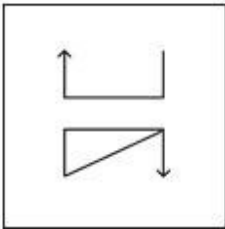

Q.7 Select the combination of letters that when sequentially placed in the blanks of the given series will complete the series.

JIG\_KG\_U\_EGZM\_GE

Ans

✗ 1. PGMC

✗ 2. NGCL

✗ 3. NGMC

✓ 4. PGLC

Q.8 Select the set in which the numbers are related in the same way as are the numbers of the following sets.  
(NOTE : Operations should be performed on the whole numbers, without breaking down the numbers into its constituent digits. E.g. 13 – Operations on 13 such as adding/subtracting/multiplying etc. to 13 can be performed. Breaking down 13 into 1 and 3 and then performing mathematical operations on 1 and 3 is not allowed.)  
(25, 8, 11)  
(28, 8, 12)

Ans

✗ 1. (22, 13, 19)

✓ 2. (17, 7, 8)

✗ 3. (42, 6, 21)

✗ 4. (15, 5, 8)

Q.9 What should come in place of the question mark (?) in the given series?

50, 51, 54, 55, 58, ?

- Ans
- 1. 62
  - 2. 64
  - 3. 59
  - 4. 60

Q.10 Select the combination of letters that when sequentially placed in the blanks of the given series will complete the series.  
a \_ z b \_ y c \_ x \_ a z \_ b y c c \_ a a \_ b b \_ c c x \_ a z \_ b y \_ c x

- Ans
- 1. acbacxzyabc
  - 2. bacazbxyacb
  - 3. bacabzxyabc
  - 4. abcabxzyabc

Q.11 What will come in the place of the question mark (?) in the following equation if '+' and '-' are interchanged and '×' and '÷' are interchanged?

$$24 \div 9 + 182 \times 13 - 2 = ?$$

- Ans
- 1. 204
  - 2. 238
  - 3. 172
  - 4. 224

Q.12 Select the option figure in which the given figure is embedded as its part (rotation is NOT allowed).

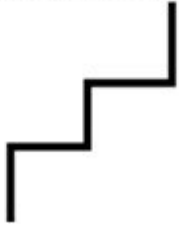

Ans

1.

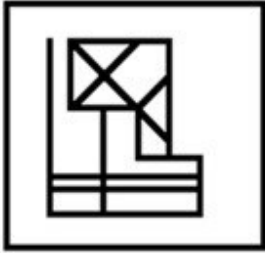

2.



3.

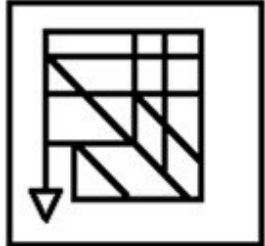

4.



Q.13 CEHM is related to YADI in a certain way based on the English alphabetical order. In the same way, IKNS is related to EGJO. To which of the following is OQTY related, following the same logic?

Ans  1. KOPU

2. KNOU

3. KMPU

4. KNPU

Q.14 13 is related to 156 following a certain logic. Following the same logic, 22 is related to 264. To which of the following is 31 related following the same logic?

(NOTE : Operations should be performed on the whole numbers, without breaking down the numbers into its constituent digits. E.g. 13 – Operations on 13 such as adding /deleting /multiplying etc., to 13 can be performed. Breaking down 13 into 1 and 3 and then performing mathematical operations on 1 and 3 is not allowed.)

Ans  1. 376

2. 370

3. 374

4. 372

Q.15 Which of the following numbers will replace the question mark (?) in the given series?  
800 400 480 240 320 ?

- Ans
- 1. 180
  - 2. 200
  - 3. 160
  - 4. 120

Q.16 Three of the following four are alike in a certain way and thus form a group. Which is the one that does NOT belong to that group?  
(Note: The odd one out is not based on the number of consonants/vowels or their position in the letter cluster.)

- Ans
- 1. RVX
  - 2. JNP
  - 3. CGI
  - 4. HKM

Q.17 In a certain code language,  
'A + B' means 'A is the sister of B',  
'A - B' means 'A is the brother of B',  
'A × B' means 'A is the father of B',  
'A ÷ B' means 'A is the daughter of B'.  
Based on the above, how is K related to P if 'J ÷ K + L × O - P'?

- Ans
- 1. Mother
  - 2. Father's sister
  - 3. Mother's sister
  - 4. Sister

Q.18 Select the correct mirror image of the given combination when the mirror is placed at MN as shown below.



- Ans
- 1.  $\Sigma$  b a m  $\nabla$  R
  - 2. d 2 m s  $\nabla$  R
  - 3. R 7 a m d 2
  - 4.  $\Sigma$  b m s  $\nabla$  R

Q.19 In a certain code language, 'DARK' is coded as '3975' and 'READ' is coded as '5873'. How is 'K' coded in the given language?

- Ans
- 1. 7
  - 2. 9
  - 3. 3
  - 4. 5

Q.20 How many rectangles are there in the figure?

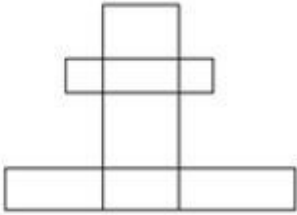

- Ans
- 1. 15
  - 2. 16
  - 3. 17
  - 4. More than 17

Q.21 In a certain code language, 'TWIN' is coded as 2359 and 'WING' is coded as 5302. What is the code for 'T' in the given code language?

- Ans
- 1. 2
  - 2. 9
  - 3. 3
  - 4. 5

Adda247 Marathi

Q.22 Select the correct mirror image of the given figure when the mirror is placed at AB.

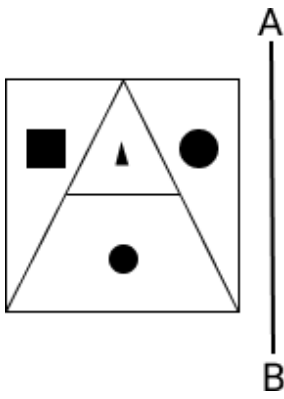

Ans

✗ 1.

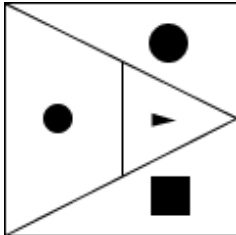

✗ 2.

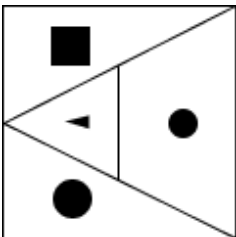

✓ 3.

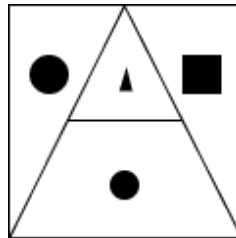

✗ 4.

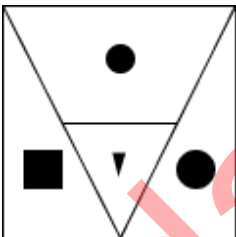

Q.23 What will come in the place of the question mark (?) in the following equation, if '+' and '-' are interchanged and '×' and '÷' are interchanged?

$$17 \div 4 - 28 + 125 \times 5 = ?$$

Ans

✓ 1. 71

✗ 2. 74

✗ 3. 73

✗ 4. 72

Q.24 If 18 January 2013 was Friday, then what was the day of the week on 19 December 2021?

Ans

✓ 1. Sunday

✗ 2. Thursday

✗ 3. Saturday

✗ 4. Wednesday

Q.25 Three statements are followed by conclusions numbered I, II. You have to consider these statements to be true, even if they seem to be at variance with commonly known facts. Decide which of the given conclusions logically follow/s from the given statement.

Statements:

All ground is wind.

Some tables are ground.

All wind is earth.

Conclusion (I): No tables are earth.

Conclusion (II): All earth is ground.

- Ans
- 1. Only conclusion (I) follows.
  - 2. Neither conclusion (I) nor (II) follows.
  - 3. Only conclusion (II) follows.
  - 4. Both conclusions (I) and (II) follow.

Section : Quantitative Aptitude

Q.1 Study the following graph and answer the question that follows.  
The following bar graph shows the percentage profit earned by two companies A and B over the given years.

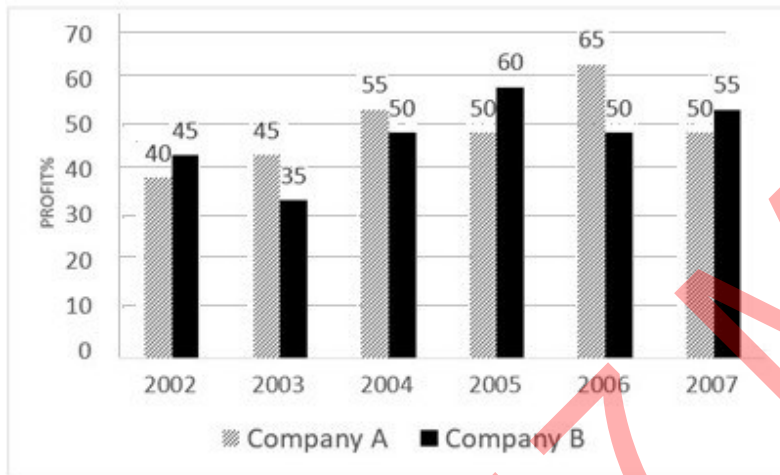

The incomes of two companies A and B in 2006 were in the ratio 3 : 4, respectively. What was the respective ratio of their expenditures in 2006?

- Ans
- 1. 14 : 19
  - 2. 7 : 22
  - 3. 27 : 35
  - 4. 15 : 22

Q.2 Shantanu's income decreased from ₹42,800 to ₹37,236. Find the percentage decrease in his income.

- Ans
- 1. 12%
  - 2. 11%
  - 3. 14%
  - 4. 13%



Q.3

The value of  $1\frac{1}{3} \div \left[ 2\frac{1}{6} \div \left\{ 14\frac{1}{3} - \left( 2\frac{1}{3} + 3\frac{1}{2} \right) \right\} \right]$  is:

Ans

1.  $3\frac{2}{13}$

2.  $5\frac{3}{13}$

3.  $4\frac{3}{17}$

4.  $3\frac{2}{17}$

Q.4

The table shows the percentage distribution of the population (only male and female) according to Gender and Literacy.

State	Percentage literate	Gender	
		Literate	Illiterate
		M : F	M : F
A	55	5 : 6	4 : 5
B	72	1 : 1	3 : 2
C	78	4 : 3	3 : 2

If state B has 7 crore people, then the number of illiterate females in the state is:

Ans

1. 117.6 lakhs

2. 78.4 lakhs

3. 201.6 lakhs

4. 130.67 lakhs

Q.5

A shopkeeper sold an article at a 26% profit. On selling it for ₹2,250 more, he would get a profit of 41%. If this article is sold at 12% profit, then the selling price would be:

Ans

1. ₹16,800

2. ₹15,000

3. ₹15,800

4. ₹16,120

Q.6

Study the given bar-graph and answer the question that follows.

The bar-graph shows the production of refrigerators (in thousand) by five different companies A, B, C, D and E during 2004 to 2007.

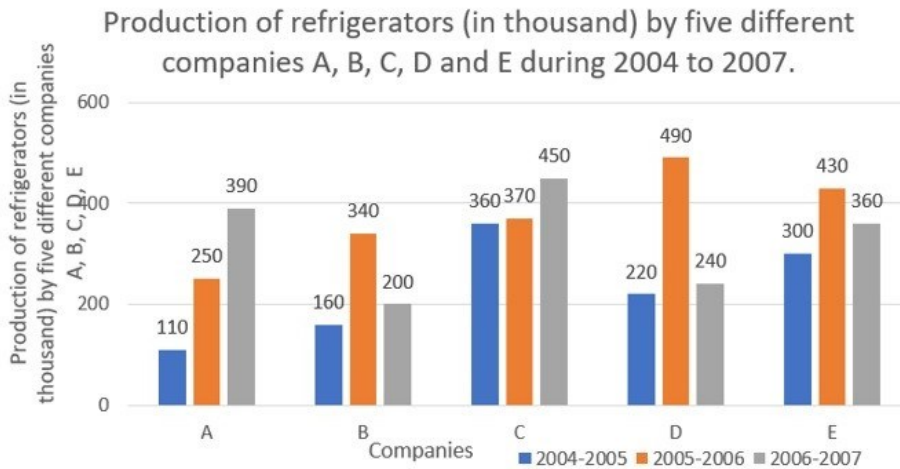

What is the difference between 60% of the average production of refrigerators by all the companies for the year 2005-2006 and 70% of the average of all the companies in 2006-2007?

- Ans
- 1. 4000
  - 2. 40
  - 3. 400
  - 4. 4

Q.7

The following graph shows the wheat imports (in thousand tonnes) over the five years:

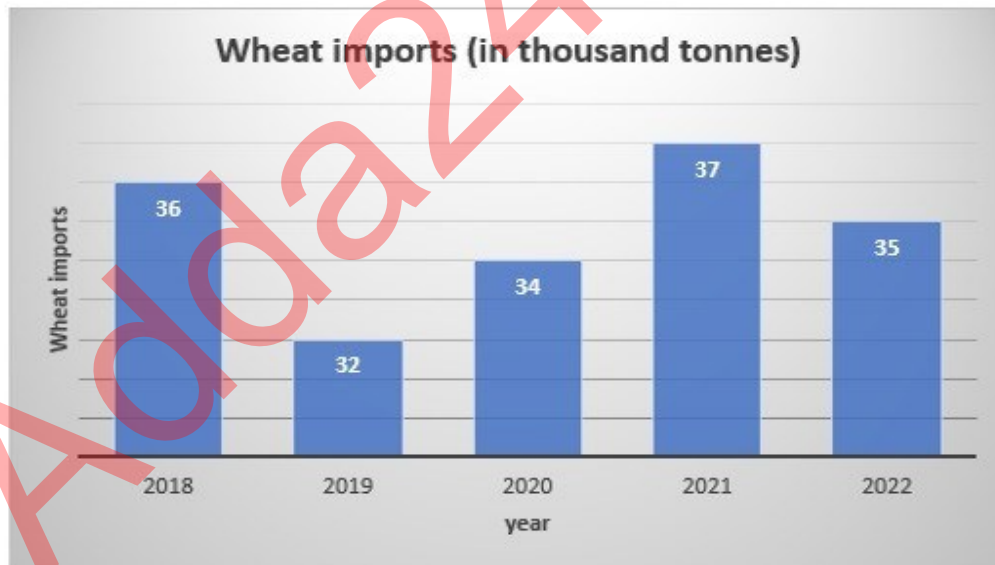

What is the ratio of the years which have below-average imports to those which have above-average imports?

- Ans
- 1. 3 : 1
  - 2. 3 : 2
  - 3. 2 : 3
  - 4. 1 : 3

Q.8 Out of a class of 200 people, 50 people's average marks is 40, and the remaining 150 people's average is 60. Find the people's weighted average.

- Ans
- 1. 50
  - 2. 55
  - 3. 150
  - 4. 200

Q.9 In how many years will a sum of ₹4,250 yield a simple interest of ₹510 at a rate of 6% per annum?

- Ans
- 1.  $3\frac{1}{2}$  years
  - 2.  $2\frac{1}{2}$  years
  - 3. 3 years
  - 4. 2 years

Q.10 Teena does half of a task in 6 days. Later, with Shyam's help, she completes the remaining work in 4 days. Shyam alone can finish the entire work in:

- Ans
- 1. 21 days
  - 2. 24 days
  - 3. 18 days
  - 4. 12 days

Q.11  $\triangle ABC$  and  $\triangle DEF$  are similar triangles, and their areas are  $81 \text{ cm}^2$  and  $144 \text{ cm}^2$ , respectively. If  $EF = 20 \text{ cm}$ , then what is the value of  $BC$ ?

- Ans
- 1. 9 cm
  - 2. 13 cm
  - 3. 15 cm
  - 4. 12 cm

Q.12 In two successive years, 75 and 50 employees of a company appeared at the departmental examination. Respectively, 84% and 52% of them passed. The average rate of pass percentage is:

- Ans
- 1.  $41\frac{1}{5}\%$
  - 2. 41%
  - 3. 71%
  - 4.  $71\frac{1}{5}\%$

Q.13 Let  $C$  be a circle with center  $O$  and  $PQ$  be the diameter of  $C$ . Let  $AB$  be a chord on  $C$ . If  $\angle QOB = 40^\circ$ ,  $\angle AOP = 80^\circ$ , then find  $\angle AOB$ .

- Ans
- 1.  $100^\circ$
  - 2.  $60^\circ$
  - 3.  $90^\circ$
  - 4.  $70^\circ$

Q.14 The sum of the present ages of a father and son is 50 years. If after 5 years, the father's age will be 5 times the age of the son, then what was the father's age 5 years ago?

- Ans
- 1. 36
  - 2. 47
  - 3. 43
  - 4. 40

Q.15 If  $640 \div 8 + 930 \div 15 - k + 32 \times 5 = 1104 \div 16 \times 148 \div 37$ , then the value of  $k$  is:

- Ans
- 1. 276
  - 2. 26
  - 3. 35
  - 4. 302

Q.16 Find the whole surface area of a cuboid having a length of 19 cm, breadth of 9 cm and height of 4.5 cm.

- Ans
- 1.  $619 \text{ cm}^2$
  - 2.  $497 \text{ cm}^2$
  - 3.  $917 \text{ cm}^2$
  - 4.  $594 \text{ cm}^2$

Q.17 Simplify  $\frac{\sin 60^\circ - \cos 60^\circ}{\sin 60^\circ + \cos 60^\circ}$ .

- Ans
- 1.  $2 + \sqrt{3}$
  - 2.  $\sqrt{3} - 1$
  - 3.  $2 - \sqrt{3}$
  - 4.  $\sqrt{3} - 2$

Q.18  $\triangle ABC \sim \triangle EDF$  and  $\text{area}(\triangle ABC) : \text{area}(\triangle EDF) = 1 : 4$ . If  $AB = 7 \text{ cm}$ ,  $BC = 8 \text{ cm}$  and  $CA = 9 \text{ cm}$ , then  $DF$  is equal to:

- Ans
- 1. 16 cm
  - 2. 18 cm
  - 3. 14 cm
  - 4. 12 cm

Q.19 Two circles of radii 3 units and  $r$  units, respectively, have a 6 units distance between their centers. If the length of the direct common tangent is  $\sqrt{35}$  units, then the value of  $r$  is \_\_\_ units.

- Ans
- 1. 6
  - 2. 4
  - 3. 5
  - 4. 3

Q.20 Find the mean proportion to 0.72 and 2.85 (round up to one decimal place).

- Ans
- 1. 0.4
  - 2. 2.8
  - 3. 0.7
  - 4. 1.4

Q.21 There are two circles touching each other externally. The radius of the first circle with centre O is 12 cm. The radius of the second circle with centre A is 5 cm. Find the length of their common tangent touching the two circles at points P and Q.

- Ans
- 1.  $4\sqrt{15}$  cm
  - 2.  $14\sqrt{5}$  cm
  - 3.  $5\sqrt{41}$  cm
  - 4.  $5\sqrt{14}$  cm

Q.22 The cost price of a fan is ₹4,400. A merchant wants to make a 24% profit by selling it. At the time of sale, merchant declares a discount of 12% on the marked price. Find the marked price.

- Ans
- 1. ₹2,600
  - 2. ₹2,060
  - 3. ₹6,200
  - 4. ₹6,020

Q.23 The price of a product increases by 10% in the first year and 20% in the second year. What is the overall percentage increase in the price of the product over the two years?

- Ans
- 1. 30%
  - 2. 32%
  - 3. 28%
  - 4. 36%

Q.24 If the speed of a boat in still water is 3 km/h and if its speed upstream is 1 km/h, find the speed of the stream.

- Ans
- 1. 2 km/h
  - 2. 1 km/h
  - 3. 0.25 km/h
  - 4. 0.5 km/h

Q.25 The surface area of a spherical ball is  $1386 \text{ cm}^2$ . What will be its volume?

- Ans
- 1.  $4825 \text{ cm}^3$
  - 2.  $5000 \text{ cm}^3$
  - 3.  $4851 \text{ cm}^3$
  - 4.  $4800 \text{ cm}^3$

Section : General Awareness

1. In badminton, 0 points is called \_\_\_\_\_.

- Ans
- 1. ~~0~~
  - 2. love
  - 3. play
  - 4. out

Q.2 Which of the following statements is INCORRECT with respect to High Yielding Varieties (HYVs)?

Ans  1. HYVs had a shorter period of maturity.

2.

The usage of HYVs was complemented with the attraction of more investment in farm machines.

3. HYVs led to decrease in the cropping intensity.

4. They made green revolution technology as land-saving technology.

3. The Sun Temple at Konark was built under the rule of which dynasty?

Ans  1. Pallava Dynasty

2. Pandya Dynasty

3. Eastern Ganga Dynasty

4. Rashtrakuta Dynasty

Q.4 Who was the chief guest at the first Republic Day celebration of India in 1950?

Ans  1. Sukarno

2. Kwame Nkrumah

3. Josip Broz Tito

4. Gamal Abdel Nasser

Q.5 From which of the following states was Vibrant Village programme launched, on 10 April 2023?

Ans  1. Sikkim

2. Arunachal Pradesh

3. Mizoram

4. Nagaland

Q.6 Which of the following planets does NOT have rings?

Ans  1. Uranus

2. Venus

3. Jupiter

4. Saturn

Q.7 The Lucknow Gharana which came into existence in the time of Wajid Ali Shah was developed by who among the following?

Ans  1. Ustad Bakhtawar Khan

2. Pandit Kalka Prasad

3. Pandit Thakur Prasad

4. Pandit Bindawar Prasad

Q.8 Which writ literally means 'what is your authority'?

Ans  1. Habeas Corpus

2. Mandamus

3. Quo-Warranto

4. Prohibition

Q.9 As of 2022, which is the tallest hydroelectric power plant in India?

- Ans
- 1. Sardar Sarovar Hydropower Plant
  - 2. Nathpa Jhakri Power plant
  - 3. Koyna Hydroelectric Power Plant
  - 4. Tehri Hydroelectric Power Plant

Q.10 Which of the following types is NOT an element of classical Carnatic music?

- Ans
- 1. Kritis
  - 2. Padam
  - 3. Sthayi
  - 4. Thumri

Q.11 Who was the Indian Buddhist monk who is credited with the development of many ancient martial art forms in the 5<sup>th</sup> century?

- Ans
- 1. Bodhidharma
  - 2. Atisa
  - 3. Bodhiruchi
  - 4. Paramartha

Q.12 What is the keyboard shortcut for inserting a new slide into an MS-PowerPoint presentation?

- Ans
- 1. Ctrl + S
  - 2. Ctrl + X
  - 3. Ctrl + M
  - 4. Ctrl + N

Q.13 In Fencing, a defensive blade movement that blocks the opponent's offensive action is called \_\_\_\_\_.

- Ans
- 1. parry
  - 2. reprise
  - 3. saber
  - 4. redoublement

Q.14 Which Article of the Constitution of India vests plenary powers in Parliament to legislate on the subject of citizenship?

- Ans
- 1. Article 8
  - 2. Article 5
  - 3. Article 11
  - 4. Article 6

Q.15 Select the INCORRECT pair of the location of the refinery and its state from the following

- Ans
- 1. Tatipaka Refinery – Telangana
  - 2. Bina Refinery – Madhya Pradesh
  - 3. Koyali Refinery – Gujarat
  - 4. Numaligarh Refinery – Assam

Q.16 Which folk music does NOT belong to Tamil Nadu?

- Ans
- 1. Ammanaivari
  - 2. Villu Pattu
  - 3. Khubakeshei
  - 4. Nattupura

Q.17 What is the name of the famous British social reformer known for founding the Indian Home Rule League in 1916?

- Ans
- 1. Maria Rye
  - 2. Annie Besant
  - 3. Catherine Osler
  - 4. Anne Knight

Q.18 Match India's neighbouring countries in column A with their official languages in column B.

Column A (Country names)	Column B (Official Languages)
1. Sri Lanka	a. Mandarin
2. China	b. Burmese
3. Myanmar	c. Tamil
4. Bhutan	d. Dzongkha

- Ans
- 1. 1-d, 2-a, 3-b, 4-c
  - 2. 1-c, 2-a, 3-b, 4-d
  - 3. 1-a, 2-b, 3-c, 4-d
  - 4. 1-b, 2-a, 3-c, 4-d

Q.19 Which of the following is a rare group of genetic disorders caused by mutations of certain genes affecting the colour (pigmentation) of the skin, hair and eyes?

- Ans
- 1. Alkaptonuria
  - 2. Alagille syndrome
  - 3. Albinism
  - 4. Angelman syndrome

Q.20 In Microsoft Word, the Mail Merge Wizard is located under the \_\_\_\_\_ tab.

- Ans
- 1. Review
  - 2. Home
  - 3. Insert
  - 4. Mailings

Q.21 In which of the following years was the Juvenile Justice (Care and Protection of Children) Act, 2015 amended?

- Ans
- 1. 2015
  - 2. 2021
  - 3. 2019
  - 4. 2013

Q.22 What is a revenue deficit in the government budget?

- Ans
- 1. The excess of expenditure over revenue, excluding interest payments on debt
  - 2. The excess of revenue over expenditure, including interest payments on debt
  - 3. The excess of revenue over expenditure, excluding interest payments on debt
  - 4. The excess of expenditure over revenue, including interest payments on debt

Q.23 The \_\_\_\_\_ results from an increase in the proportion of workers relative to non-workers in the population.

- Ans
- 1. age structure of population
  - 2. demographic dividend
  - 3. population momentum
  - 4. old-age dependency ratio



**Q.24** For which of the following discoveries in 1827 was the German physicist, Georg Simon Ohm best known?

- Ans**
- 1. For clarifying the mathematical relationship between electrical current, resistance and voltage
  - 2. For measuring the magnetic properties of nuclear particles
  - 3. For invention of the magnetometer, which is a device capable of measuring the direction and strength of a magnetic field
  - 4. For developing a device capable of amplifying and modulating electromagnetic signals that could also function as an oscillator

**Q.25** Which of the following Sections of the Indian Penal Code deals with 'rape'?

- Ans**
- 1. Section 370
  - 2. Section 380
  - 3. Section 375
  - 4. Section 385

Adda247 Marathi

## Combined Higher Secondary Level Examination 2024 Tier I

Exam Date	11/07/2024
Exam Time	5:15 PM - 6:15 PM
Subject	CHSL Exam 2024 Tier I

### Section : English Language

1. Parts of the following sentence have been given as options. Select the option that contains an error.

Geeta was working now but she can be seen swimming in the river every evening.

- Ans
- 1. swimming in the
  - 2. river every evening.
  - 3. but she can be seen
  - 4. Geeta was working now

2. The following sentence has been split into four segments. Identify the segment that contains a grammatical error. The manager asked / the cooking team, "Who / among you is to baked the / Christmas cake this year?"

- Ans
- 1. Christmas cake this year?"
  - 2. The manager asked
  - 3. among you is to baked the
  - 4. the cooking team, "Who

3. Select the grammatically INCORRECT sentence.

- Ans
- 1. They often meet each other.
  - 2. They always meet each other.
  - 3. They quite meet each other.
  - 4. They hardly meet each other.

- Q.4 The following sentence has been divided into four segments. Identify the segment that contains a grammatical error. The new / secretary / does not likes / me.

- Ans
- 1. me.
  - 2. secretary
  - 3. The new
  - 4. does not likes

**Comprehension:**

In the following passage, some words have been deleted. Read the passage carefully and select the most appropriate option to fill in each blank.

Teachers 1\_\_\_\_\_given continuous opportunities for self-improvement and to learn the latest innovations and advances in their professions. Each teacher 2\_\_\_\_\_expected to participate in at least 50 hours of CPD opportunities every year for their own professional development, driven 3\_\_\_\_\_their own interests. CPD opportunities will, in particular, 4\_\_\_\_\_cover the latest pedagogies regarding foundational literacy and numeracy, formative and adaptive assessment of learning outcomes, competency-based learning and related pedagogies, 5\_\_\_\_\_experiential learning, arts-integrated, sports-integrated and storytelling-based approaches, etc.

**SubQuestion No : 5**

**Q.5** Select the most appropriate option to fill in blank number 1.

- Ans**
- 1. shall be
  - 2. will be
  - 3. can be
  - 4. would be

**Comprehension:**

In the following passage, some words have been deleted. Read the passage carefully and select the most appropriate option to fill in each blank.

Teachers 1\_\_\_\_\_given continuous opportunities for self-improvement and to learn the latest innovations and advances in their professions. Each teacher 2\_\_\_\_\_expected to participate in at least 50 hours of CPD opportunities every year for their own professional development, driven 3\_\_\_\_\_their own interests. CPD opportunities will, in particular, 4\_\_\_\_\_cover the latest pedagogies regarding foundational literacy and numeracy, formative and adaptive assessment of learning outcomes, competency-based learning and related pedagogies, 5\_\_\_\_\_experiential learning, arts-integrated, sports-integrated and storytelling-based approaches, etc.

**SubQuestion No : 6**

**Q.6** Select the most appropriate option to fill in blank number 2.

- Ans**
- 1. shall be
  - 2. would be
  - 3. can be
  - 4. will be

**Comprehension:**

In the following passage, some words have been deleted. Read the passage carefully and select the most appropriate option to fill in each blank.

Teachers 1\_\_\_\_\_given continuous opportunities for self-improvement and to learn the latest innovations and advances in their professions. Each teacher 2\_\_\_\_\_expected to participate in at least 50 hours of CPD opportunities every year for their own professional development, driven 3\_\_\_\_\_their own interests. CPD opportunities will, in particular, 4\_\_\_\_\_cover the latest pedagogies regarding foundational literacy and numeracy, formative and adaptive assessment of learning outcomes, competency-based learning and related pedagogies, 5\_\_\_\_\_experiential learning, arts-integrated, sports-integrated and storytelling-based approaches, etc.

**SubQuestion No : 7**

**Q.7** Select the most appropriate option to fill in blank number 3.

- Ans**
- 1. by
  - 2. from
  - 3. at
  - 4. for

**Comprehension:**

In the following passage, some words have been deleted. Read the passage carefully and select the most appropriate option to fill in each blank.

Teachers 1\_\_\_\_\_given continuous opportunities for self-improvement and to learn the latest innovations and advances in their professions. Each teacher 2\_\_\_\_\_expected to participate in at least 50 hours of CPD opportunities every year for their own professional development, driven 3\_\_\_\_\_their own interests. CPD opportunities will, in particular, 4\_\_\_\_\_cover the latest pedagogies regarding foundational literacy and numeracy, formative and adaptive assessment of learning outcomes, competency-based learning and related pedagogies, 5\_\_\_\_\_experiential learning, arts-integrated, sports-integrated and storytelling-based approaches, etc.

**SubQuestion No : 8**

**Q.8** Select the most appropriate option to fill in blank number 4.

- Ans**
- 1. carelessly
  - 2. systematically
  - 3. roughly
  - 4. partially

**Comprehension:**

In the following passage, some words have been deleted. Read the passage carefully and select the most appropriate option to fill in each blank.

Teachers 1\_\_\_\_\_given continuous opportunities for self-improvement and to learn the latest innovations and advances in their professions. Each teacher 2\_\_\_\_\_expected to participate in at least 50 hours of CPD opportunities every year for their own professional development, driven 3\_\_\_\_\_their own interests. CPD opportunities will, in particular, 4\_\_\_\_\_cover the latest pedagogies regarding foundational literacy and numeracy, formative and adaptive assessment of learning outcomes, competency-based learning and related pedagogies, 5\_\_\_\_\_experiential learning, arts-integrated, sports-integrated and storytelling-based approaches, etc.

**SubQuestion No : 9**

**Q.9** Select the most appropriate option to fill in blank number 5.

- Ans**
- 1. same as
  - 2. such as
  - 3. from as
  - 4. for as

**Q.10** Select the most appropriate **ANTONYM** of the underlined word.

The waters of Germany are abundant in fish, but there are few genera and species in them.

- Ans**
- 1. deficient
  - 2. flourish
  - 3. allay
  - 4. discord

**Q.11** Select the most appropriate synonym of the given word.

**Revolution**

- Ans**
- 1. Stagnation
  - 2. Gyration
  - 3. Harmony
  - 4. Order

**Q.12** Select the most appropriate **ANTONYM** for the given word.

**Ghastly**

- Ans**
- 1. Agitated
  - 2. Bitter
  - 3. Relaxing
  - 4. Pleasant

Q.13 Select the most appropriate option that can substitute the underlined segment in the given sentence. If there is no need to substitute it, select 'No substitution required'.  
I opened the box beneath the table and took of a book, the Materia Medica.

- Ans
- 1. took out
  - 2. take off
  - 3. took in
  - 4. No substitution required

Q.14 Parts of the following sentence have been given as options. Select the option that contains a spelling error. I was alarmed lest we should be wreked.

- Ans
- 1. I was
  - 2. be wreked.
  - 3. we should
  - 4. alarmed lest

Q.15 Based on the situation in the sentence, select the most appropriate idiom.  
After many years of rivalry, the two schools decided to \_\_\_\_\_ and participate in a National Event together.

- Ans
- 1. bell the cat
  - 2. bury the hatchet
  - 3. go cold turkey
  - 4. be in the doldrums

Q.16 Choose the option that best describes the meaning of the idioms and phrases underlined in the given sentence.  
A jack of all trades cannot survive in the world of specialisation.

- Ans
- 1. A good communicator
  - 2. A person who can do many things but is not an expert in any
  - 3. An expert of many jobs
  - 4. A businessman

Q.17 Select the most appropriate option that can substitute the underlined segment in the given sentence.

Do not later about the street.

- Ans
- 1. loiter around
  - 2. litre about
  - 3. litter about
  - 4. latter about

Q.18 Select the most appropriate ANTONYM of the given word.  
Compulsory

- Ans
- 1. Optional
  - 2. Reliable
  - 3. Factional
  - 4. Full-fledged

Q.19 Select the most appropriate option that can substitute the underlined segment in the given sentence.

Well, I prefer eating at home from eating out.

- Ans
- 1. and eating out
  - 2. than eating out
  - 3. while eating out
  - 4. to eating out

Q.20 Rectify the sentence by selecting the correct spelling from the options.

The advertisement of vacancies in education sector has received huge response.

- Ans
- 1. Vecencies
  - 2. Vacansies
  - 3. Vecancies
  - 4. Vacancies

Q.21 Select the most appropriate ANTONYM of the underlined word in the given sentence.  
The athlete looked unsettled before the race.

- Ans
- 1. Confident
  - 2. Reticent
  - 3. Triumphant
  - 4. Tangent

Q.22 Select the most appropriate synonym of the given word.  
Candid

- Ans
- 1. Cruel
  - 2. Bright
  - 3. Top
  - 4. Honest

Q.23 Select the most appropriate option to fill in the blank.

The artist received a \_\_\_\_\_ from the audience.

- Ans
- 1. handful of applause
  - 2. round of applause
  - 3. bunch of applause
  - 4. plenty of applause

Q.24 Select the most appropriate option that can substitute the underlined word in the given sentence.  
The experienced surgeon handled the delicate procedure with care and precision.

- Ans
- 1. seasoned
  - 2. amateur
  - 3. untrained
  - 4. unskilled

Q.25 Select the most appropriate ANTONYM of the underlined word in the following sentence.  
I have left it to his discretion to accept or decline my offer.

- Ans
- 1. Wisdom
  - 2. Calculation
  - 3. Inattention
  - 4. Judgement

Q.1 Select the option figure in which the given figure (X) is embedded as its part (rotation is NOT allowed).

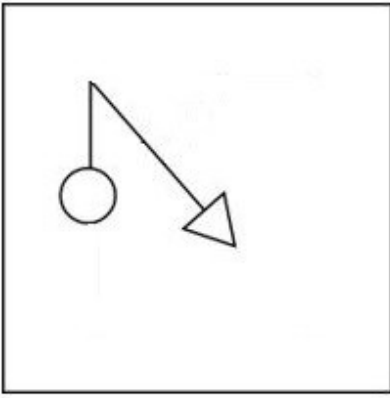

(X)

Ans

✓ 1.

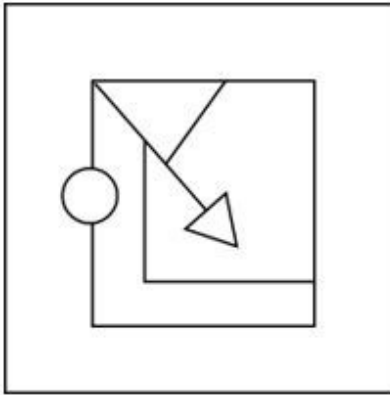

✗ 2.

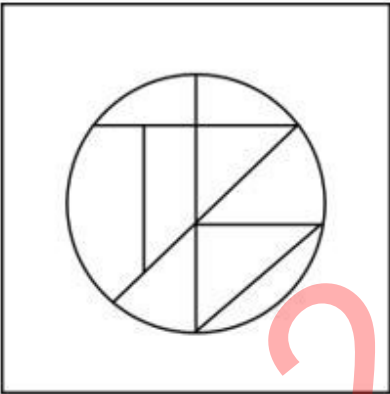

✗ 3.



✗ 4.

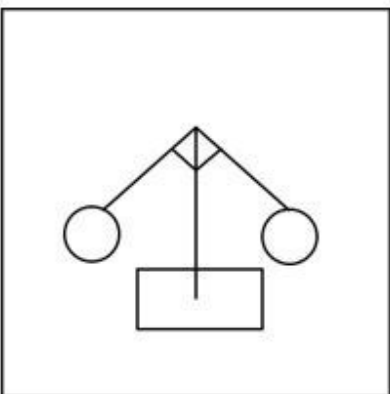

2. Each of the letters in the word FRANCHISE are arranged from left to right in alphabetical order to form a new word. How many letters are there in the English alphabetical series between the alphabet which is fifth from the left and the one which is third from the right in the newly formed word?

- Ans
- 1. Seven
  - 2. Five
  - 3. Four
  - 4. Six

Q.3 CYRF is related to NJCQ in a certain way based on the English alphabetical order. In the same way, GBUM is related to RMFX. To which of the following is CZKP related, following the same logic?

- Ans
- 1. NKVA
  - 2. NAKV
  - 3. NKAV
  - 4. NAVK

Q.4 If 'A' stands for '+', 'B' stands for 'x', 'C' stands for '+' and 'D' stands for '-', then the resultant of which of the following will be 421?

- Ans
- 1. 63 B 7 A 125 D 5 C 5
  - 2. 63 A 7 D 125 B 5 C 5
  - 3. 63 B 7 D 125 A 5 C 5
  - 4. 63 C 7 D 125 A 5 B 5

Q.5 In this question, three statements are given, followed by three conclusions numbered I, II and III. Assuming the statements to be true, even if they seem to be at variance with commonly known facts, decide which of the conclusion(s) logically follows/follow from the statements.

Statements:

No rose is an orchid.

All roses are lilies.

All lilies are lotuses.

Conclusions:

I. Some lilies are orchids.

II. Some lotuses are orchids.

III. All lilies are orchids.

- Ans
- 1. Both conclusions I and III follow.
  - 2. Neither conclusions I, II nor III follows.
  - 3. Both conclusions I and II follow.
  - 4. Both conclusions II and III follow.

Q.6 What would be the Roman numeral on the opposite side of 'V' if the given sheet is folded to form a cube?

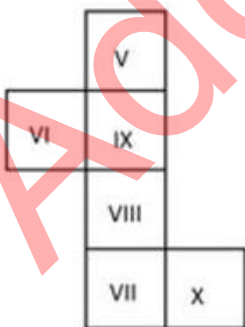

- Ans
- 1. VII
  - 2. X
  - 3. VIII
  - 4. VI



Q.7 Select the correct mirror image of the given figure when the mirror is placed at AB as shown below.

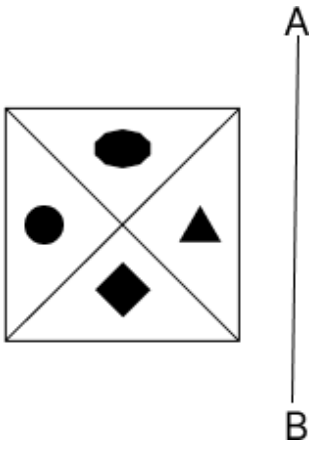

Ans

X 1.

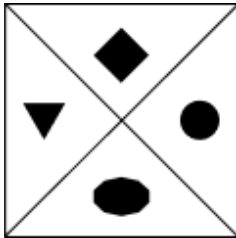

X 2.



✓ 3.

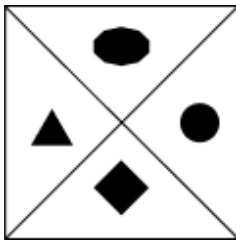

X 4.

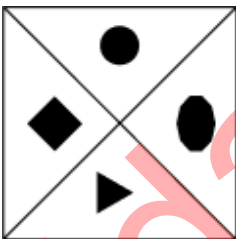

Q.8 What should come in place of ? in the given series based on the English alphabetical order?

QRS MXB IDK EJT ?

Ans

X 1. PCA

X 2. CPA

✓ 3. APC

X 4. AAC

Q.9 In a certain code language, 'mix jaggery well' is written as 'rb co ot' and 'well done boss' is written as 'cx rb op'. How is 'well' written in the given language?

- Ans
- 1. CO
  - 2. CX
  - 3. ot
  - 4. rb

Q.10 Find the number of triangles in the given figure.

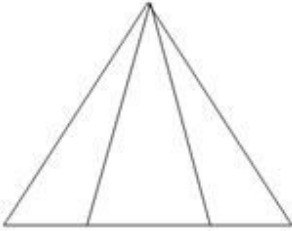

- Ans
- 1. 8
  - 2. 6
  - 3. 4
  - 4. 5

Q.11 Which of the following letter-clusters can replace the question mark (?) in the given series to make it logically complete? JMD, OHJ, ?, YXV, DSB

- Ans
- 1. RST
  - 2. AOZ
  - 3. TCP
  - 4. VCP

Q.12 What should come in place of the question mark (?) in the given series?

86, 88, 90, 92, 94, ?

- Ans
- 1. 99
  - 2. 96
  - 3. 97
  - 4. 98

Q.13 78 is related to 30 following a certain logic. Following the same logic, 67 is related to 26. To which of the following is 54 related, following the same logic?

- Ans
- 1. 18
  - 2. 20
  - 3. 16
  - 4. 28

Q.14 What will come in the place of the question mark (?) in the following equation, if '+' and '-' are interchanged and '×' and '÷' are interchanged?

$$125 \div 5 + 19 - 190 \times 19 = ?$$

- Ans
- 1. 606
  - 2. 636
  - 3. 616
  - 4. 626

Q.15 In a certain language, 'protect your health' is written as 'Df Bk Tu' and 'health is wealth' is written as 'Po Tu Le'. How is 'health' written in the given language?

- Ans
- 1. Df
  - 2. Po
  - 3. Bk
  - 4. Tu

Q.16 IJLO is related to GHJM in a certain way based on the English alphabetical order. In the same way, HIKN is related to FGIL. To which of the following is EFHK related, following the same logic?

- Ans
- 1. CEDI
  - 2. CDFI
  - 3. CDEF
  - 4. CEFI

Q.17 Three of the following four are alike in a certain way and thus form a group. Which is the one that does NOT belong to that group?

(Note: The odd one out is not based on the number of consonants/vowels or their position in the letter cluster.)

- Ans
- 1. UXY
  - 2. JMN
  - 3. DGH
  - 4. ORT

Q.18 What will come in the place of the question mark (?) in the following equation, if '+' and '-' are interchanged and '×' and '÷' are interchanged?

$$87 \div 3 + 35 - 88 \times 11 = ?$$

- Ans
- 1. 231
  - 2. 233
  - 3. 234
  - 4. 232

Q.19 If 25 August 2006 was Friday, then what was the day of the week on 25 August 2018?

- Ans
- 1. Saturday
  - 2. Sunday
  - 3. Thursday
  - 4. Wednesday

Q.20 Identify the figure given in the options that when put in place of the question mark (?) will logically complete the series.

	O	T	L	B	
B L T	4 B L	C 4 B	↑ C 4		?
4	C	↑	D		

Ans

✗ 1.

		4
D	↑	B
8		

✓ 2.

		4
D	↑	C
8		

✗ 3.

		4
D	8	B
↑		

✗ 4.

		4
D	↑	C
B		

Q.21 Which of the following numbers will replace the question mark (?) in the given series?

$[\frac{5}{9}]$ ,  $[\frac{14}{9}]$ ,  $[\frac{23}{9}]$ ,  $[\frac{32}{9}]$ ,  $[\frac{41}{9}]$ , ?

Ans

✗ 1.  $[\frac{44}{9}]$

✗ 2.  $[\frac{51}{9}]$

✗ 3.  $[\frac{47}{9}]$

✓ 4.  $[\frac{50}{9}]$

**Q.22** A square sheet of paper is folded along the dotted line successively along the directions shown and is then punched in the last. How would the paper look when unfolded?

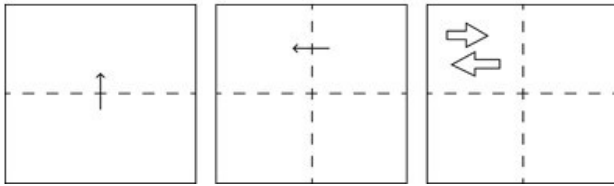

**Ans**

1.

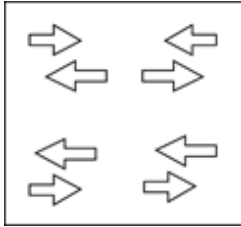

2.

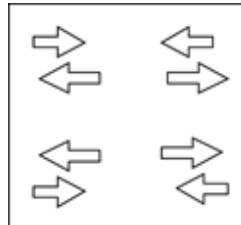

3.

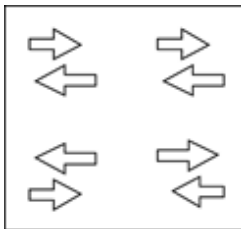

4.

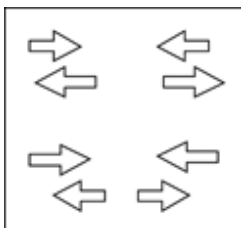

**Q.23** Select the set in which the numbers are related in the same way as are the numbers of the following sets.  
(NOTE: Operations should be performed on the whole numbers, without breaking down the numbers into their constituent digits. E.g. 13 – Operations on 13 such as adding/subtracting/multiplying etc. to 13 can be performed. Breaking down 13 into 1 and 3 and then performing mathematical operations on 1 and 3 is not allowed.)

(4, 8, 32)  
(7, 14, 56)

**Ans**

1. (11, 22, 88)

2. (11, 33, 88)

3. (11, 33, 77)

4. (11, 22, 77)

**Q.24** In a certain code language,  
A % B means 'A is the mother of B'  
A # B means 'A is the brother of B'  
A @ B means 'A is the wife of B'  
A & B means 'A is the father of B'  
Based on the above, how is P related to T if 'P & Q % R # S @ T'?

**Ans**

1. Wife's father

2. Wife's mother's father

3. Wife's mother's brother

4. Wife's brother

Q.25 What would be the letter on the opposite side of 'P' if the given sheet is folded to form a cube?

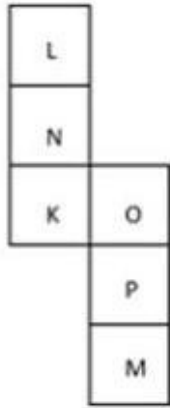

- Ans
- 1. L
  - 2. N
  - 3. M
  - 4. K

Section : Quantitative Aptitude

Q.1 The following bar graph represents the total number of students enrolled and the number of students who got campus placement in six different engineering colleges A, B, C, D, E, and F. Study the graph carefully and answer the question given below:

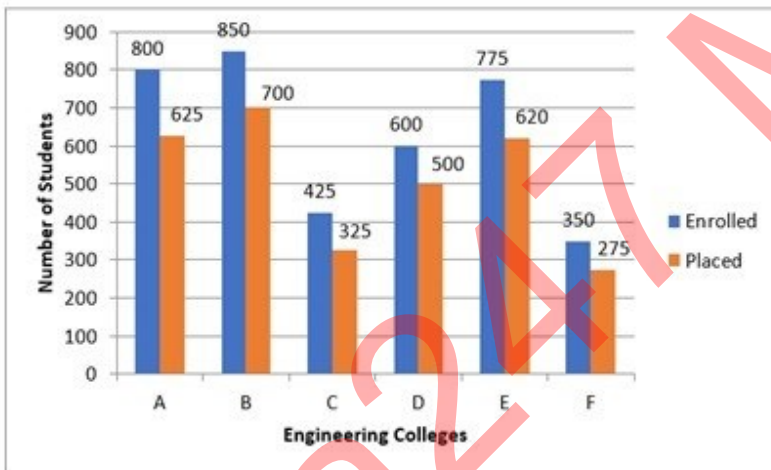

What per cent (correct up to two decimal places) of total enrolled students have got campus placements in colleges A, C, and F?

- Ans
- 1. 86.67%
  - 2. 77.78%
  - 3. 82.78%
  - 4. 79.67%

Q.2

The following table gives the percentage of marks obtained by seven students in six different subjects in an examination.

The numbers in the brackets give the maximum marks in each subject.

Student	Subject (Max. Marks)					
	Maths	Chemistry	Physics	Geography	History	Computer Science
	(150)	(130)	(120)	(100)	(60)	(40)
Ayush	90	50	90	60	70	80
Aman	100	80	80	40	80	70
Sajal	90	60	70	70	90	70
Rohit	80	65	80	80	60	60
Muskan	80	65	85	95	50	90
Tanvi	70	75	65	85	40	60
Tarun	65	35	50	77	80	80

How many students secured a raw score of 135 in Maths?

Ans



1. 0



2. 2



3. 1



4. 3

Q.3

If L is the mid-point of side BC of  $\triangle ABC$  and the area of  $\triangle ABL$  is  $15 \text{ cm}^2$ , then the area (in  $\text{sq cm}$ ) of  $\triangle ABC$  is:

Ans



1. 32



2. 30



3. 27



4. 25

Q.4

In  $\triangle ABC$ , D and E are points on sides AB and AC, such that  $DE \parallel BC$ . If  $AD = x$ ,  $DB = x - 3$ ,  $AE = x + 3$  and  $EC = x - 2$ , then the value of x is:

Ans



1. 5.2



2. 4.0



3. 4.5



4. 4.2

Q.5

X, Y and Z can do a work in 24 days, 5 days and 12 days, respectively. In how many days can they do the same work if they work together?

Ans



1. 4 days

2.  $3\frac{1}{13}$  days3.  $\frac{1}{24}$  days4.  $\frac{7}{24}$  days

Q.6 If  $\frac{15}{8} + \left[ \left\{ \frac{4}{5} \text{ of } \frac{5}{12} \div \left( 1 \frac{1}{15} \right) \right\} \times 1 \frac{7}{12} \right]$  is expressed in the form of  $\frac{a}{b}$  where a and b are integers and relatively prime to each other, the value  $4b - a$  is:

- Ans
- 1. 313
  - 2. 225
  - 3. 164
  - 4. 189

Q.7 If the price of a commodity is increased by 36%, by what percentage (rounded off to 1 decimal place) should its consumption be decreased so that the expenditure of the commodity stays the same?

- Ans
- 1. 26.5%
  - 2. 36%
  - 3. 29.5%
  - 4. 32%

Q.8 In an obtuse-angled triangle ABC, the length of its longest side AB is 50 cm and one of the other two sides is 42 cm. If the area of the triangle is  $294 \text{ cm}^2$ , what is the length (in cm) of its third side?

- Ans
- 1.  $8\sqrt{35}$
  - 2.  $15\sqrt{21}$
  - 3.  $2\sqrt{58}$
  - 4.  $12\sqrt{43}$

Q.9 The given chart represents the sales of automobiles in India (by type, in million units) from the year 2011 to 2014. Study the chart and answer the question that follows.

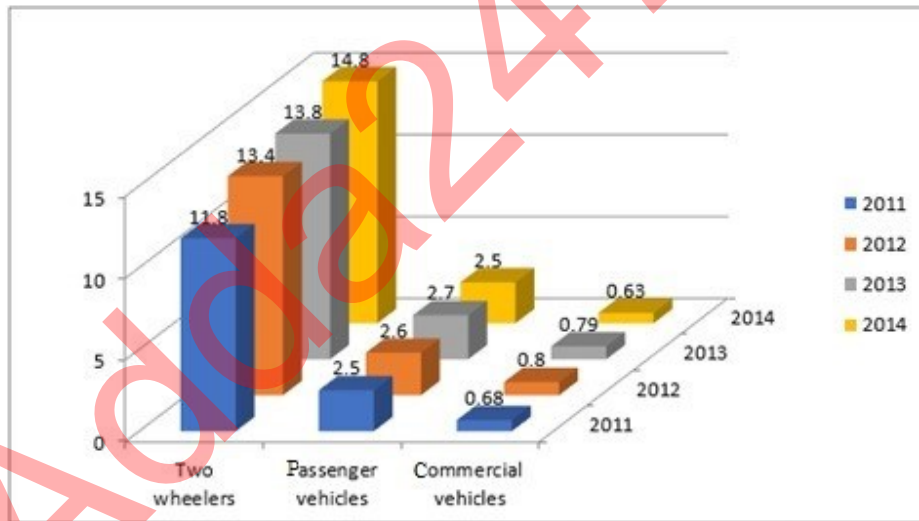

The percentage increase in the sales in 2013 over the previous year was the maximum for which of the categories of vehicles?

- Ans
- 1. Two wheelers
  - 2. Commercial vehicles
  - 3. Passenger vehicles
  - 4. Two wheelers and Passenger vehicles



Q.10 Tom travelled 285 km in 6 hours. In his total travelling, he travelled the first part by bus at 40 km/hr and the remaining part by train at 55 km/hr. How much distance has he travelled by train?

- Ans
- 1. 155 km
  - 2. 120 km
  - 3. 165 km
  - 4. 135 km

Q.11 The average of 50 numbers is 23. If each number is multiplied by 13, then the new average is:

- Ans
- 1. 219
  - 2. 299
  - 3. 650
  - 4. 88

Q.12 What should be added to each term of the ratio 5 : 11 so that the ratio becomes 3 : 5?

- Ans
- 1. 6
  - 2. 4
  - 3. 2
  - 4. 5

Q.13 A cylindrical candle, 14 cm in diameter and length 2 cm is melted to form a cuboid candle of dimensions 7 cm × 11 cm × 2 cm. How many cuboidal candles can be obtained?

- Ans
- 1. 4
  - 2. 5
  - 3. 2
  - 4. 3

Q.14 A right angled triangle of area  $600 \text{ m}^2$  is to be made such that the hypotenuse is double the base. For the triangle, the hypotenuse is \_\_\_\_\_ more than the base.

- Ans
- 1. 20.36 m
  - 2. 22.32 m
  - 3. 24.36 m
  - 4. 26.32 m

Q.15 How much simple interest will ₹5,000 earn in 14 months at a 12% interest rate per annum?

- Ans
- 1. ₹600
  - 2. ₹800
  - 3. ₹700
  - 4. ₹500

Q.16 Refer to the bar graph below and answer the question that follows.

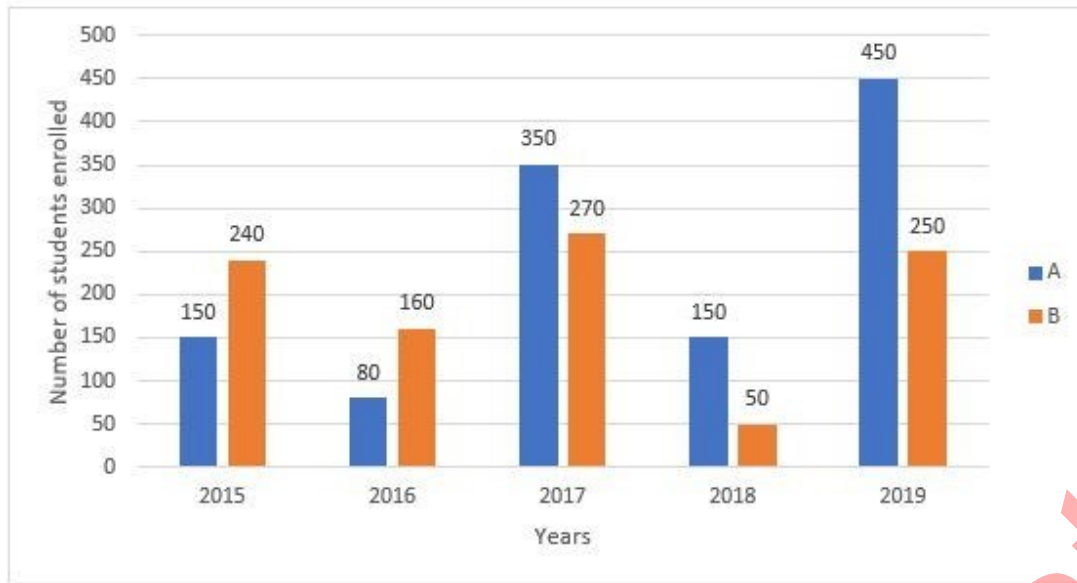

What is the difference between the number of students enrolled in Institute A in 2015 and 2017 and that in Institute B in 2016, 2018 and 2019?

- Ans
- 1. 40
  - 2. 150
  - 3. 75
  - 4. 100

Q.17 If 10% of 24% of  $x$  is 240, then  $x = ?$

- Ans
- 1. 100
  - 2. 1000
  - 3. 10000
  - 4. 100000

Q.18 If  $\tan A + \sin A = x$ ,  $\tan A - \sin A = y$ , what is the value of  $x^2 - y^2$ ?

- Ans
- 1.  $2\sqrt{\frac{x}{y}}$
  - 2.  $4\sqrt{\frac{x}{y}}$
  - 3.  $\sqrt{xy}$
  - 4.  $4\sqrt{xy}$

Q.19 The number 611611611611 is:  
(a) divisible by both 6 and 11  
(b) neither divisible by 6 nor by 11  
(c) divisible by 6 only  
(d) divisible by 11 only

- Ans
- 1. (d)
  - 2. (c)
  - 3. (b)
  - 4. (a)

Q.20 My father is presently 25 years older than me. The sum of our ages 5 years ago was 39 years. Find my present age.

- Ans
- 1. 13 years
  - 2. 12 years
  - 3. 15 years
  - 4. 20 years

Q.21 An election was held between two candidates. The winning candidate scored 54% of the valid votes and won by 88 votes. If 58 votes were declared invalid, then find the total number of votes polled in the election.

- Ans
- 1. 1850
  - 2. 1158
  - 3. 1156
  - 4. 2000

Q.22 The salary of employees in a factory was reduced by 20% due to economic crisis. In order to have their salary back to original amount, it must be raised by:

- Ans
- 1. 20%
  - 2. 12.5%
  - 3. 40%
  - 4. 25%

Q.23 What is the area (in square units) of the sector if the radius of the circle is given to be 24 units and the arc length is 7.5 units?

- Ans
- 1. 135
  - 2. 180
  - 3. 45
  - 4. 90

Q.24 The volume of rectangular block is  $12288 \text{ m}^3$ . Its dimension are in the ratio of 4 : 3 : 2. If the entire surface is polished at the rate 2 paise per  $\text{m}^2$ , then find the total cost of polishing

- Ans
- 1. ₹33.28
  - 2. ₹44.42
  - 3. ₹66.56
  - 4. ₹11.14

Q.25 The marked price of a table lamp is ₹2,165. During the festive season, it is sold for ₹1,710.35. Find the percentage discount offered.

- Ans
- 1. 21%
  - 2. 20.5%
  - 3. 18%
  - 4. 22.5%

Section : General Awareness

1. Which of the following is the fastest way to open the Help window in Microsoft Word?

- Ans
- 1. Type 'help' in the search bar and then, press Enter
  - 2. Click the Microsoft Office button and then, click Help
  - 3. Press F1
  - 4. Click the Help button on the ribbon

2. Which star is also known as the 'Pole Star'?

- Ans
- 1. The West star
  - 2. The South star
  - 3. The North star
  - 4. The East star

3. According to Census 2011, which union territory recorded the highest female literacy rate in India?

- Ans
- 1. Delhi
  - 2. Lakshadweep
  - 3. Chandigarh
  - 4. Puducherry

Q.4 In Equestrian sports, \_\_\_\_\_ occurs when a horse or rider lowers an element of a jump that establishes the height of an obstacle.

- Ans
- 1. canter
  - 2. curb
  - 3. clean round
  - 4. knockdown

Q.5 Which group of states was concentrated in the cotton production in the early years to develop textile industry?

- Ans
- 1. West Bengal and Odisha
  - 2. Bihar and West Bengal
  - 3. Maharashtra and Gujarat
  - 4. Punjab and Haryana

Q.6 Which of the following hills is located in the Eastern most part of India?

- Ans
- 1. Patkai Bum Hills
  - 2. Jaintia Hills
  - 3. Khasi Hills
  - 4. Garo Hills

Q.7 Who among the following is NOT associated with the Green Revolution?

- Ans
- 1. MS Swaminathan
  - 2. P Chidambaram
  - 3. Norman Borlaug
  - 4. Chidambaram Subramaniam

Q.8 Who among the following is related to Hindustani classical singing?

- Ans
- 1. Mallikarjun Mansur
  - 2. Srinavasa Iyer
  - 3. Aruna Sairam
  - 4. Ramanuj Iyengar

Q.9 The original constitution did NOT mention any fundamental duty because:

- Ans
- 1. initially fundamental duties were not expected to be performed
  - 2. it was expected that the citizens of the country would perform their duties willingly
  - 3. it was expected that the citizens of the country would perform their duties forcefully
  - 4. initially fundamental duties were punishable as per the constitution

Q.10 Which of the following measures can be adopted by the government to reduce revenue deficit?

- Ans
- 1. Offering freebies
  - 2. Increasing subsidies
  - 3. Increasing money supply
  - 4. Tax reforms

Q.11 Every year in the month of February, this camel festival is organised by Rajasthan Tourism Development Corporation in \_\_\_\_\_.

- Ans
- 1. Barmer
  - 2. Bikaner
  - 3. Jaisalmer
  - 4. Jodhpur

Q.12 MLAs in which of the following states/UTs received an increase of about 66% in salaries and allowances w.e.f. 14 February 2023?

- Ans
- 1. Tamil Nadu
  - 2. Lakshadweep
  - 3. Delhi
  - 4. Bihar

Q.13 From which book is the national song of India compiled?

- Ans
- 1. Anand Math
  - 2. Mandukya Upanishad
  - 3. Katha Upanishad
  - 4. Bharat Bharti

Q.14 With reference to 'Saila dance' consider the following statements and select the correct option.

- a) A group comprising of male performers.
- b) The dance is performed with bamboo sticks.
- c) It is performed after the cutting of crops.

- Ans
- 1. a, b, c
  - 2. Both b and c
  - 3. Both a and c
  - 4. Both a and b

Q.15 Who was the first person to conduct a systematic study of chromosomes during division and called this process mitosis?

- Ans
- 1. Friedrich Miescher
  - 2. Thomas Hunt Morgan
  - 3. Antonie van Leeuwenhoek
  - 4. Walther Flemming

Q.16 In cricket, a fast, head-high delivery of the ball is referred to as \_\_\_\_\_.

- Ans
- 1. grubber
  - 2. leg-bye
  - 3. duck
  - 4. bouncer

Q.17 According to the Census of India 2011, which of the following states has the largest Buddhist population?

- Ans
- 1. Uttar Pradesh
  - 2. Maharashtra
  - 3. Madhya Pradesh
  - 4. West Bengal

Q.18 Who captained India to victory in the 2011 Cricket World Cup final win over Sri Lanka?

- Ans
- 1. Sourav Ganguly
  - 2. Mahendra Singh Dhoni
  - 3. Sachin Tendulkar
  - 4. Rahul Dravid

Q.19 Which function is used to calculate the maximum value in a selected column in MS Excel?

- Ans
- 1. Auto max
  - 2. High
  - 3. Max
  - 4. Auto high

Q.20 Which British colonel is remembered as the Butcher of Amritsar for his role in the Jallianwala Bagh massacre in 1919?

- Ans
- 1. Reginald Dyer
  - 2. Robert Clive
  - 3. William Birdwood
  - 4. William Slim

Q.21 The 42<sup>nd</sup> Constitutional Amendment Act of Indian Constitution was passed in the year \_\_\_\_\_.

- Ans
- 1. 1976
  - 2. 1977
  - 3. 1978
  - 4. 1979

Q.22 In which of the following liquids would anthracene dissolve easily?

- Ans
- 1. Benzene
  - 2. Sodium chloride
  - 3. Methane
  - 4. Water

Q.23 In March 2023, the Uttarakhand government had approved how much horizontal reservation for statehood activists in state government jobs?

- Ans
- 1. 10%
  - 2. 15%
  - 3. 8%
  - 4. 5%

Q.24 The Press and Registration of Books (PRB) Act was enacted in which year?

- Ans
- 1. 1887
  - 2. 1877
  - 3. 1867
  - 4. 1857

Q.25 Who amongst the following Delhi Sultanate rulers sent his army under Malik Kafur's command to conquer South India?

- Ans
- 1. Ghiyas-ud-din Balban
  - 2. Iltutmish
  - 3. Alauddin Khilji
  - 4. Qutub-al-din Aibak

Adda247 Marathi