

DO NOT OPEN THIS TEST BOOKLET UNTIL YOU ARE TOLD TO DO SO

T.B.C. : MNGY-D-ETE



Test Booklet Series



Serial

1003867

TEST BOOKLET

Paper - II

(ELECTRICAL ENGINEERING)

Time Allowed : Three Hours

Maximum Marks : 300

INSTRUCTIONS

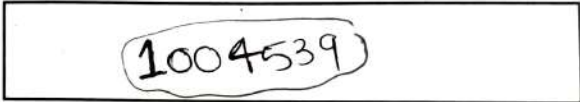
1. IMMEDIATELY AFTER THE COMMENCEMENT OF THE EXAMINATION, YOU SHOULD CHECK THAT THIS TEST BOOKLET **DOES NOT** HAVE ANY UNPRINTED OR TORN OR MISSING PAGES OR ITEMS, ETC. IF SO, GET IT REPLACED BY A COMPLETE TEST BOOKLET.
2. Please note that it is the candidate's responsibility to encode and fill in the Roll Number and Test Booklet Series Code A, B, C or D carefully and without any omission or discrepancy at the appropriate places in the OMR Answer Sheet. Any omission/discrepancy will render the Answer Sheet liable for rejection.
3. You have to enter your Roll Number on the Test Booklet in the Box provided alongside. **DO NOT** write *anything else* on the Test Booklet. 
4. This Test Booklet contains 150 items (questions). Each item comprises four responses (answers). You will select the response which you want to mark on the Answer Sheet. In case you feel that there is more than one correct response, mark the response which you consider the best. In any case, choose **ONLY ONE** response for each item.
5. You have to mark all your responses **ONLY** on the separate Answer Sheet provided. See directions in the Answer Sheet.
6. All items carry equal marks.
7. Before you proceed to mark in the Answer Sheet the response to various items in the Test Booklet, you have to fill in some particulars in the Answer Sheet as per instructions sent to you with your Admission Certificate.
8. After you have completed filling in all your responses on the Answer Sheet and the examination has concluded, you should hand over to the Invigilator **only the Answer Sheet**. You are permitted to take away with you the Test Booklet.
9. Sheets for rough work are appended in the Test Booklet at the end.
10. **Penalty for wrong answers :**  
**THERE WILL BE PENALTY FOR WRONG ANSWERS MARKED BY A CANDIDATE.**
  - (i) There are four alternatives for the answer to every question. For each question for which a wrong answer has been given by the candidate, **one-third** of the marks assigned to that question will be deducted as penalty.
  - (ii) If a candidate gives more than one answer, it will be treated as a **wrong answer** even if one of the given answers happens to be correct and there will be same penalty as above to that question.
  - (iii) If a question is left blank, i.e., no answer is given by the candidate, there will be **no penalty** for that question.

DO NOT OPEN THIS TEST BOOKLET UNTIL YOU ARE TOLD TO DO SO

1. The fundamental period of complex signal  $x(t) = e^{j\omega_0 t}$  is
- (a)  $2\pi/\omega_0$
  - (b)  $\pi/\omega_0$
  - (c)  $2\pi\omega_0$
  - (d)  $\pi\omega_0$

2. The energy contained of the signal  $x(t) = e^{-2t} u(t)$  is
- $\int_0^{\infty} e^{-2t} \cdot dt$
- $\frac{e^{-2t}}{-2}$
- $-\frac{1}{2} [0 - 1]$
- $\frac{1}{2}$
- (a)  $\frac{1}{2}$
  - (b) 2
  - (c)  $\frac{1}{4}$
  - (d) 4

3. Which one of the following is a useful property of the unit impulse signal  $\delta(t)$ ?
- (a)  $\delta(at) = a\delta(t)$
  - (b)  $\delta(at) = \delta(t)$
  - (c)  $\delta(at) = [\delta(t)]^{-a}$
  - (d)  $\delta(at) = \frac{1}{|a|} \delta(t)$

4. Which one of the following is correct for the system represented by the relation  $y(t) = x(\sin(t))$ , where  $x(t)$  and  $y(t)$  are input and output respectively?
- (a) It is causal and linear.
  - (b) It is non-causal and linear.
  - (c) It is causal and non-linear.
  - (d) It is non-causal and non-linear.

5. The Fourier series representations are based on using
- (a) constant coefficients
  - (b) cosine functions only
  - (c) sine functions only
  - (d) orthogonal functions

6. What is the Fourier transform of rectangular pulse as shown in the figure below?

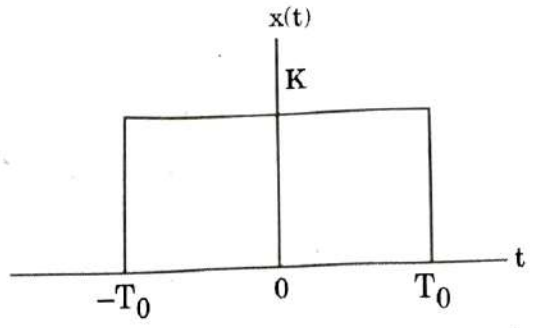

- (a)  $2KT_0 \text{sinc}\left(\frac{\omega T_0}{\pi}\right)$
- (b)  $2KT_0 \text{sinc}\left(\frac{\omega T_0}{2\pi}\right)$
- (c)  $KT_0 \text{sinc}\left(\frac{\omega T_0}{\pi}\right)$
- (d)  $KT_0 \text{sinc}\left(\frac{\omega T_0}{2\pi}\right)$

7. What is the Fourier transform of the function  $f(t) = te^{-|t|}$ ?

- (a)  $\frac{4j\omega}{(1+\omega^2)^2}$
- (b)  $\frac{-4j\omega}{(1+\omega^2)^2}$
- (c)  $\frac{4j\omega}{(1+\omega)^2}$
- (d)  $\frac{-4j\omega}{(1+\omega)^2}$

$e^{-at} x(t)$

$t e^{-t} \Rightarrow \frac{d}{d\omega} x(\omega)$

$\Rightarrow \frac{d}{d\omega} \left[ \frac{1}{1+\omega} \right]$

$\frac{-1}{(1+\omega)^2}$

**DO NOT OPEN THIS TEST BOOKLET UNTIL YOU ARE TOLD TO DO SO**

**T.B.C. : MNGY-D-ETE**



**Test Booklet Series**

**Serial**

1003867

**TEST BOOKLET**

**Paper - II**

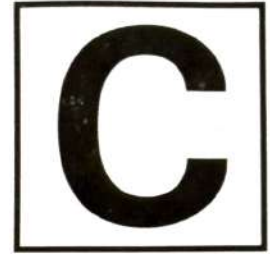

**(ELECTRICAL ENGINEERING)**

**Time Allowed : Three Hours**

**Maximum Marks : 300**

**INSTRUCTIONS**

1. IMMEDIATELY AFTER THE COMMENCEMENT OF THE EXAMINATION, YOU SHOULD CHECK THAT THIS TEST BOOKLET **DOES NOT** HAVE ANY UNPRINTED OR TORN OR MISSING PAGES OR ITEMS, ETC. IF SO, GET IT REPLACED BY A COMPLETE TEST BOOKLET.
  2. Please note that it is the candidate's responsibility to encode and fill in the Roll Number and Test Booklet Series Code A, B, C or D carefully and without any omission or discrepancy at the appropriate places in the OMR Answer Sheet. Any omission/discrepancy will render the Answer Sheet liable for rejection.
  3. You have to enter your Roll Number on the Test Booklet in the Box provided alongside.  
**DO NOT** write *anything else* on the Test Booklet.
- 1004539
4. This Test Booklet contains **150** items (questions). Each item comprises four responses (answers). You will select the response which you want to mark on the Answer Sheet. In case you feel that there is more than one correct response, mark the response which you consider the best. In any case, choose **ONLY ONE** response for each item.
  5. You have to mark all your responses **ONLY** on the separate Answer Sheet provided. See directions in the Answer Sheet.
  6. All items carry equal marks.
  7. Before you proceed to mark in the Answer Sheet the response to various items in the Test Booklet, you have to fill in some particulars in the Answer Sheet as per instructions sent to you with your Admission Certificate.
  8. After you have completed filling in all your responses on the Answer Sheet and the examination has concluded, you should hand over to the Invigilator **only the Answer Sheet**. You are permitted to take away with you the Test Booklet.
  9. Sheets for rough work are appended in the Test Booklet at the end.
  10. **Penalty for wrong answers :**  
**THERE WILL BE PENALTY FOR WRONG ANSWERS MARKED BY A CANDIDATE.**
    - (i) There are four alternatives for the answer to every question. For each question for which a wrong answer has been given by the candidate, **one-third** of the marks assigned to that question will be deducted as penalty.
    - (ii) If a candidate gives more than one answer, it will be treated as a **wrong answer** even if one of the given answers happens to be correct and there will be same penalty as above to that question.
    - (iii) If a question is left blank, i.e., no answer is given by the candidate, there will be **no penalty** for that question.

**DO NOT OPEN THIS TEST BOOKLET UNTIL YOU ARE TOLD TO DO SO**

1. The fundamental period of complex signal  $x(t) = e^{j\omega_0 t}$  is
- (a)  $2\pi/\omega_0$
  - (b)  $\pi/\omega_0$
  - (c)  $2\pi\omega_0$
  - (d)  $\pi\omega_0$

2. The energy contained of the signal  $x(t) = e^{-2t} u(t)$  is
- $\int_0^{\infty} e^{-2t} dt = \frac{e^{-2t}}{-2} \Big|_0^{\infty} = -\frac{1}{2} [0 - 1] = \frac{1}{2}$
- (a)  $\frac{1}{2}$
  - (b) 2
  - (c)  $\frac{1}{4}$
  - (d) 4

3. Which one of the following is a useful property of the unit impulse signal  $\delta(t)$  ?
- (a)  $\delta(at) = a\delta(t)$
  - (b)  $\delta(at) = \delta(t)$
  - (c)  $\delta(at) = [\delta(t)]^{-a}$
  - (d)  $\delta(at) = \frac{1}{|a|} \delta(t)$

4. Which one of the following is correct for the system represented by the relation  $y(t) = x(\sin(t))$ , where  $x(t)$  and  $y(t)$  are input and output respectively ?
- (a) It is causal and linear.
  - (b) It is non-causal and linear.
  - (c) It is causal and non-linear.
  - (d) It is non-causal and non-linear.

5. The Fourier series representations are based on using
- (a) constant coefficients
  - (b) cosine functions only
  - (c) sine functions only
  - (d) orthogonal functions

6. What is the Fourier transform of rectangular pulse as shown in the figure below ?

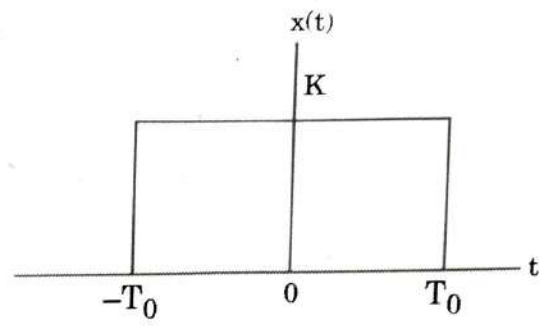

- (a)  $2KT_0 \text{sinc}\left(\frac{\omega T_0}{\pi}\right)$
- (b)  $2KT_0 \text{sinc}\left(\frac{\omega T_0}{2\pi}\right)$
- (c)  $KT_0 \text{sinc}\left(\frac{\omega T_0}{\pi}\right)$
- (d)  $KT_0 \text{sinc}\left(\frac{\omega T_0}{2\pi}\right)$

7. What is the Fourier transform of the function  $f(t) = te^{-|t|}$  ?

- (a)  $\frac{4j\omega}{(1 + \omega^2)^2}$
  - (b)  $\frac{-4j\omega}{(1 + \omega^2)^2}$
  - (c)  $\frac{4j\omega}{(1 + \omega^2)^2}$
  - (d)  $\frac{-4j\omega}{(1 + \omega^2)^2}$
- Handwritten notes:*  
 $e^{-at} \leftrightarrow \frac{1}{s+a}$   
 $t e^{-t} \rightarrow \frac{d}{ds} \left( \frac{1}{1+s} \right)$   
 $= \frac{-1}{(1+s)^2}$   
 $\frac{-1}{(1+\omega)^2}$

8. What is the signal  $x(t)$ , based on the following facts :

1.  $x(t)$  is periodic with period  $T_0 = 4$  and has Fourier series coefficients  $c[k]$ .
2.  $x(t)$  is real-valued.
3.  $c[k] = 0$  for  $|k| > 1$ .
4. The signal  $y(t)$ , whose Fourier series coefficients are  $d[k] = e^{-j\pi k/2} c[k]$ , is odd.

$$5. \frac{1}{4} \int_{-2}^2 |x(t)|^2 dt = \frac{1}{2}.$$

- (a)  $(2)^m \cos(\omega_0 t)$
- (b)  $(-1)^m \cos(\omega_0 t)$
- (c)  $(-1)^m \cos(2\omega_0 t)$
- (d)  $(-2)^m \cos(\omega_0/2t)$

9. From the plot shown below, what are the necessary and sufficient conditions for a second order causal LTI discrete time system to be stable ?

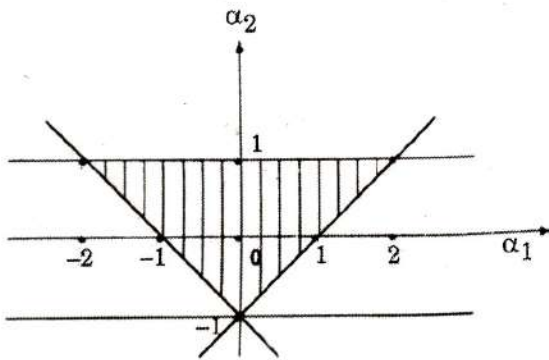

- (a)  $|\alpha_1| < 1$  &  $|\alpha_2| < 1 + \alpha_1$
- (b)  $|\alpha_2| < 1$  &  $|\alpha_1| < 1 + \alpha_2$
- (c)  $|\alpha_1| > 1$  &  $|\alpha_2| > 1 + \alpha_1$
- (d)  $|\alpha_2| > 1$  &  $|\alpha_1| > 1 + \alpha_2$

**Directions :** Each of the next six (06) items consist of two statements, one labelled as the 'Statement (I)' and the other as 'Statement (II)'. You are to examine these two statements carefully and select the answers to these items using the codes given below :

**Codes :**

- (a) Both Statement (I) and Statement (II) are individually true and Statement (II) is the correct explanation of Statement (I).
- (b) Both Statement (I) and Statement (II) are individually true, but Statement (II) is **not** the correct explanation of Statement (I).
- (c) Statement (I) is true, but Statement (II) is false.
- (d) Statement (I) is false, but Statement (II) is true.

10. **Statement (I) :**

Diodes designed expressly to operate in the forward biased region are called zener diodes.

**Statement (II) :**

The principal operating region for a zener diode is negative in terms of both voltage and current.

11. **Statement (I) :**

A small-signal equivalent circuit of a BJT that applies to both n-p-n and p-n-p transistors is valid at lower frequencies by ignoring capacitance effects.

**Statement (II) :**

Despite the structural similarities, a p-n-p BJT has higher current gain than a comparable n-p-n BJT because holes are less mobile than electrons.

12. **Statement (I) :**

MOSFETs are preferred over JFETs for digital integrated circuits, either p-channel metal-oxide semiconductor or n-channel metal-oxide semiconductor logic circuits can be constructed.

**Statement (II) :**

The usage of a p-channel MOSFET as the active load for an n-channel MOSFET leads to a logic family known as complementary-symmetry MOS or CMOS.

13. Statement (I) :

A system is LTI if and only if there exists a signal, called the system unit impulse response.

Statement (II) :

The output of a discrete-time LTI system is equal to the convolution sum between the input signal and its unit impulse response.

14. Statement (I) :

The root locus is the path of the roots of the characteristic equation traced out in the s-plane as a system parameter varies from zero to infinity.

Statement (II) :

The frequency response of a system is defined as the steady-state response of the system to a non-sinusoidal unique input signal, and the resulting output signal for a linear system is sinusoidal in the steady-state; it differs from the input only in amplitude and phase angle.

15. Statement (I) :

Transformers take advantage of the high magnetic energy density of ferromagnetic material to allow economical device design, however, the non-linear nature of ferromagnetic material leads to introduction of harmonics in current or voltage.

Statement (II) :

The non-linear nature of the transformer magnetizing inductance can lead to a transient inrush current significantly greater than the rated value of current upon energizing a transformer.

16. What is the spectral efficiency of 16-QAM ?

- (a) 1 bps/Hz
- (b) 2 bps/Hz
- (c) 3 bps/Hz
- (d) 4 bps/Hz

17. A continuous-time signal is given below :

$$x(t) = 8 \cos 200\pi t$$

What is the minimum sampling rate required to avoid aliasing ?

- (a) 100 Hz
- (b) 200 Hz
- (c) 50 Hz
- (d) 150 Hz

$$\omega_c = \frac{2\pi f}{T}$$

$$\frac{2\pi f}{2\pi} = 100$$

(100)

18. By considering the standard notations, in DACs, a glitch due to the switch associated with the most significant bit can have an amplitude almost equal to

- (a)  $2V_{ref}$
- (b)  $\frac{1}{2}V_{ref}$
- (c)  $3V_{ref}$
- (d)  $\frac{1}{3}V_{ref}$

19. What is the value of Q factor if the band pass filter is having frequencies from 800 Hz to 1200 Hz ?

- (a) 1.30
- (b) 2.45
- (c) 3.40
- (d) 4.35

$$Q = \frac{\omega_c}{2\pi \Delta f}$$

$$Q = \frac{1000}{2\pi (1200 - 800)}$$

$$Q = \frac{1000}{2\pi (400)}$$

$$Q = \frac{1000}{800\pi} \approx 0.398$$

20. An AM broadcast radio transmitter radiates 10 kW of power if modulation percentage is 60. What is the carrier power ?
- 6.25 kW
  - 8.47 kW
  - 13.60 kW
  - 10.00 kW
21. A PLL FM detector uses a VCO with  $k_f = 100$  kHz/V. If it receives an FM signal with a deviation of 75 kHz and sine-wave modulation, what is the RMS output voltage from the detector ?
- 3.57 V
  - 2.54 V
  - 1.55 V
  - 0.53 V
22. The signal power and noise power measured at the input of an amplifier are  $150 \mu\text{W}$  and  $1.5 \mu\text{W}$  respectively. If the signal power at the output is  $1.5$  W and noise power is  $40$  mW, what is the amplifier noise factor ?
- 2.666
  - 3.750
  - 4.266
  - 5.625
23. A discrete source emits one of five symbols once every millisecond with probabilities  $\frac{1}{2}$ ,  $\frac{1}{4}$ ,  $\frac{1}{8}$ ,  $\frac{1}{16}$  and  $\frac{1}{16}$  respectively. What is the source entropy ?
- 0.875 bits/symbol
  - 1.875 bits/symbol
  - 2.875 bits/symbol
  - 3.875 bits/symbol
24. According to the description of the AND instruction of 8086 microprocessor, what are the essential conditions to be satisfied while executing it ?
- The source can be a register or a memory location.
  - The destination can be a register or a memory location.
  - The source and destination must both be bytes or be words.
  - The source and the destination cannot both be memory locations in an instruction
- 1 and 2 only
  - 1 and 4 only
  - 1, 2, 3 and 4
  - 1, 2 and 3 only
25. What is the modulation index, if the  $E_{\text{max}} = 150$  mV and  $E_{\text{min}} = 70$  mV ?
- 40%
  - 30%
  - 36.4%
  - 44.6%
26. A receiver has a noise power bandwidth of 12 kHz. A resistor which matches with the receiver input impedance is connected across the antenna terminals. What is the noise power contributed by this resistor in the receiver bandwidth ?  
(Take temperature as  $30^\circ\text{C}$ )
- $2.581 \times 10^{-17}$  W
  - $3.181 \times 10^{-17}$  W
  - $4.636 \times 10^{-17}$  W
  - $5.017 \times 10^{-17}$  W

27. An amplifier has a bandwidth of 4 MHz with 10 kΩ as the input resistor. What is the rms noise voltage at the input to this amplifier if the room temperature is 25°C ?

- (a) 35.23 μV
- (b) 40.55 μV
- (c) 25.65 μV
- (d) 14.62 μV

28. How many numbers of multiplications is needed in the calculation of FFT with 64 point sequence ?

- (a) 160
- (b) 172
- (c) 192
- (d) 200

29. Which one of the following is the correct Butterworth polynomial for second order filter ?

- (a)  $s^2 + s + 1$
- (b)  $s^2 + \sqrt{2}s + 1$
- (c)  $s^2 + 2s + 1$
- (d)  $s^2 + s + 2$

30. Which one of the following is the correct relation of mapping from the 's-plane' to the 'z-plane' in bilinear transformation ?

- (a)  $s = \frac{2}{T} \left[ \frac{1+z^{-1}}{1-z^{-1}} \right]$
- (b)  $s = \frac{T}{2} \left[ \frac{1-z^{-1}}{1+z^{-1}} \right]$
- (c)  $s = \frac{T}{2} \left[ \frac{1+z^{-1}}{1-z^{-1}} \right]$
- (d)  $s = \frac{2}{T} \left[ \frac{1-z^{-1}}{1+z^{-1}} \right]$

31. If  $T_s$  represents the shaft torque and  $T_e$  the electromagnetic torque and if these are assumed positive for a generator, the net torque causing acceleration  $T_a$  is

- (a)  $T_a = T_s - T_e$
- (b)  $T_a = T_s + T_e$
- (c)  $T_a = 2T_s - T_e$
- (d)  $T_a = T_s + 2T_e$

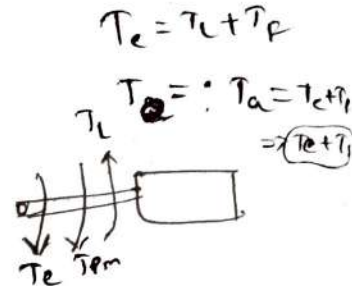

32. Consider the following conditions :

In HVDC transmission, high power factor of the system is maintained for the following reason(s) :

1. For a given current and voltage of the thyristor and transformers, the power rating of the converters is equal.
2. The stresses on the thyristors and damping circuits are reduced.
3. For the same power to be transmitted the current rating of the system is reduced and also the copper losses in the ac lines are reduced.

Which of the above conditions is/are correct ?

- (a) 1 only
- (b) 2 only
- (c) 3 only
- (d) 2 and 3 only

33. Which type of hydro turbine is totally embedded in the fluid and powered from the pressure drop across the device ?

- (a) Impulse turbine only
- (b) Reaction turbine only
- (c) Squirrel cage turbine only
- (d) Both impulse turbine and reaction turbine



34. By considering the standard notations, reverse recovery time ( $t_{rr}$ ) of a power diode is

(a)  $t_{rr} = \sqrt{\frac{2Q_R}{di/dt}}$

(b)  $t_{rr} = \sqrt{\frac{2Q_R}{dv/dt}}$

(c)  $t_{rr} = \sqrt{\frac{2dv/dt}{Q_R}}$

(d)  $t_{rr} = \sqrt{\frac{2dI/dt}{Q_R}}$

35. The overdrive factor (ODF) of a power transistor can be expressed as

(a)  $\frac{\text{base current required to operate in saturation } (I_{BS})}{\text{base current } (I_B)}$

(b)  $\frac{\text{base current } (I_B)}{\text{base current required to operate in saturation } (I_{BS})}$

(c)  $\frac{\text{base current required to operate in saturation } (I_{BS})}{\text{collector current } (I_C)}$

(d)  $\frac{\text{collector current } (I_C)}{\text{base current } (I_B)}$

36. When the amplitude of the gate pulse to thyristor is increased,

(a) the delay time would decrease, but the rise time would increase.

(b) both delay time and rise time would increase.

(c) the delay time would decrease, but the rise time remains unaffected.

(d) the delay time would increase, but the rise time would decrease.

37. A single-phase full-wave bridge rectifier circuit is fed from a 220 V, 50 Hz supply. It consists of four diodes, a load resistance 20  $\Omega$  and a very large inductance so that the load current is constant. What is the average or dc output voltage ?

(a) 78.135 V

(b) 140.125 V

(c) 198.165 V

(d) 311.025 V

38. In a single-phase full-wave controlled bridge rectifier with source inductance and R-L load, the output voltage during overlap is equal to

(a) source voltage

(b) difference of source voltage and voltage drop in inductance

(c) zero

(d) addition of source voltage and voltage drop in inductance

39. If a step-down chopper operates in the continuous conduction mode with a duty cycle D, the ripple factor is

(a)  $\frac{\sqrt{D-D^2}}{D}$

(b)  $\frac{\sqrt{D^2+D}}{D}$

(c)  $\frac{D}{\sqrt{D^2-D}}$

(d)  $\frac{D}{\sqrt{D+D^2}}$

40. When a separately excited dc motor is to be controlled from a 3-phase source for operation in the first quadrant only, which one of the following converters is used ?

(a) Three-phase dual converter

(b) Three-phase semi converter

(c) Three-phase full converter

(d) Three-phase half-wave converter

41. A wound rotor or slip-ring asynchronous motor is commonly used as drive in overhead cranes and load equalization. Which of the following speed controls is adopted ?
- Stator current control
  - Static rotor resistance control
  - Stator voltage control
  - Stator voltage and frequency control
42. Which one of the following statements is correct in a series resonant converter ?
- The load current is a square waveform.
  - The output voltage waveform depends on the damping factor of load impedance.
  - The trigger frequency is higher than the damped resonant frequency.
  - The output voltage waveform does not depend on the damping factor of load impedance.
43. Which of the following switching techniques is commonly opted in resonant converters ?
- Frequency switching
  - Voltage switching
  - Zero voltage switching or zero current switching
  - Current switching
44. The function of static transfer switch in a multimodular Uninterruptible Power Supply (UPS) system is to change over
- the power supply to the critical load from the UPS to power line
  - the battery bank to the critical load
  - the power supply to UPS
  - the battery bank to the UPS from the power line
45. Static VAR Compensator (SVC) is usually designed to operate at
- slightly lagging power factor
  - leading power factor
  - unity power factor
  - zero power factor lagging
46. The magnetic cores of large transformers are built in stepped cores to
- minimize the hysteresis loss
  - minimize the magnetizing loss
  - minimize the use of copper and decrease copper loss
  - minimize the eddy current loss
47. An autotransformer has an advantage over the equivalent two-winding transformer, which is
- no electrical isolation
  - greater short-circuit current
  - higher excitation current
  - lower leakage reactance
48. The stator and rotor slots of an asynchronous motor are designed to traverse the axial length of the magnetic core at an angle from the true axial direction. The average value of the mmf wave over the axial length of the magnetic core is
- step transition
  - ramped transition
  - steep transition
  - triangular transition
49. A 4-pole, 50-Hz, three-phase asynchronous motor is operating at a shaft speed of 1750 rpm. What is the speed of the stator air gap mmf wave ?
- $$N_s = \frac{120 \times 50}{4}$$

$$\omega = \frac{2\pi N}{60}$$

$$\Rightarrow \frac{2\pi \times 120 \times 50}{60 \times 4}$$

$$50 \times \pi$$

$$50 \times 3.14$$
- 188.49 rad/sec
  - 157.07 rad/sec
  - 127.23 rad/sec
  - 87.64 rad/sec

50. Prior to placing a three-phase, Y-connected synchronous generator in service on the Y-connected electric utility grid, three lamps are connected across the open contactors served as indicators to assure synchronization conditions if the lamps will blink OFF and ON which indicates

- (a) the voltage magnitudes of the oncoming synchronous generator and the electric utility are not matched
- (b) the frequency of the oncoming synchronous generator and the electric utility are not equal
- (c) the phase sequence of the oncoming synchronous generator and the electric utility are not matched
- (d) the voltage magnitudes, frequency and phase sequence of the oncoming synchronous generator and the electric utility are matched

51. A primitive stepper motor and its digital driver circuit is furnished with a train of  $f$  pulses per second, that the input of the controller is divided so that the output is sent in sequence to one phase winding at a time with  $2p$  as the number of phases and  $k$  number of teeth. Then the rotor angular motion per pulse is a step of

- (a)  $\pi/p$  radians
- (b)  $p/\pi$  radians
- (c)  $\pi/k2p$  radians
- (d)  $\pi/kp$  radians

52. Which one of the following statements is **not** correct ?

- (a) The corona loss on the middle conductor is more as compared with the two outer conductors.
- (b) The corona loss is less in hilly areas than in plain areas.
- (c) The rains increase the corona loss in transmission lines.
- (d) The height of the conductors from the ground has its effect on corona loss.

53.

For economic size the ratio of outer diameter to the conductor diameter should be 'e'. What is the economic overall diameter of a 1-core cable metal sheathed for a working voltage of 85 kV if the dielectric strength of the insulating material is 65 kV/cm ?

- (a) 1.6e cm
- (b) 2.6e cm
- (c) 3.6e cm
- (d) 4.6e cm

54.

When impedance is being calculated for an alternator, which measurement of parameter requires the series connection of windings in stator windings ?

- (a) Positive sequence impedance
- (b) Negative sequence impedance
- (c) Zero sequence impedance
- (d) Sub-transient reactance

55.

What is the percentage increase of busbar voltage required to compensate for the reactance drop when the feeder having a reactance of 5% carries a full load current at a p.f. 0.8 lagging ?

- (a) 3%
- (b) 4%
- (c) 1.5%
- (d) 2%

56.

The overcurrent relays are categorized by obtaining their characteristics as under :

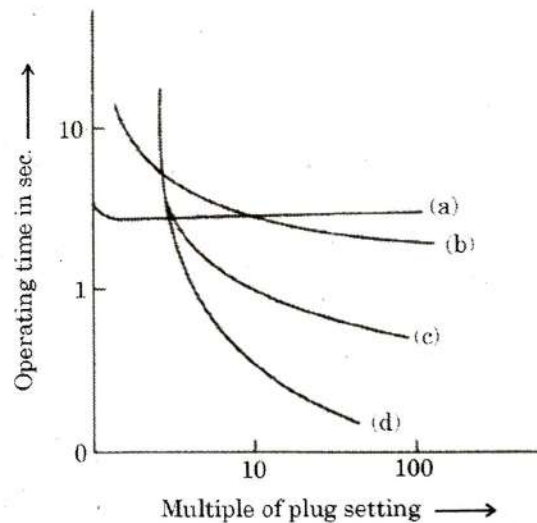

The curve (b) in the characteristics is pertaining to which category of current relay ?

- (a) Extremely inverse relay
- (b) Very inverse relay
- (c) Inverse time
- (d) Inverse definite minimum time

57. Consider the following statements :
1. The arcing time of arc controlled circuit breaker varies considerably depending upon the breaking current.
  2. Except for a certain medium range of voltages, air circuit breakers are widely used for the low voltage circuits as well as the highest transmission voltages.
  3. The resistance switching reduces help to distribute the transient recovery voltage more uniformly across the several gaps.
  4. With the use of better insulating materials for the arcing chambers, the oil C.Bs. are able to meet the increased fault levels of the systems easily.
  5. The resistance switching reduces transient voltages during switching out inductive load but enhances for capacitive loads.

Which of the above statements is/are **not** correct ?

- (a) 1 and 2 only
  - (b) 2 and 3 only
  - (c) 4 only
  - (d) 5 only
58. Consider the table below for different types of buses where each set may consist of any parameters 'V' is voltage magnitude, 'P' is real power injection, 'Q' is reactive power and 'δ' is phase angle.

Bus type	Set of quantities to be specified for bus	Set of quantities to be obtained for bus
Load bus	Set A	Set D
Slack bus	Set B	Set E
Generator bus	Set C	Set F

Select the correct answer using the above table :

- (a) Set A and E are same, but Set C and D are different
- (b) Set B and F are same, but Set C and E are different
- (c) Set C and D are same, but Set A and F are different
- (d) Set C and E are same, but Set D and B are different

59. While the load flow equations are nonlinear and they are solved by using Gauss-Seidel Iterative Method by including PV buses, what would be the reason for the violation of reactive power limit ?

- (a) Too low specified voltage level only
- (b) Too high specified voltage level only
- (c) Either too low or too high specified voltage level
- (d) Neither too low nor too high specified voltage level

60. Consider a system consisting of a synchronous machine connected to an infinite bus bar. The below power angle curve is obtained using equal area criterion when sudden increase in mechanical load on that motor occurs :

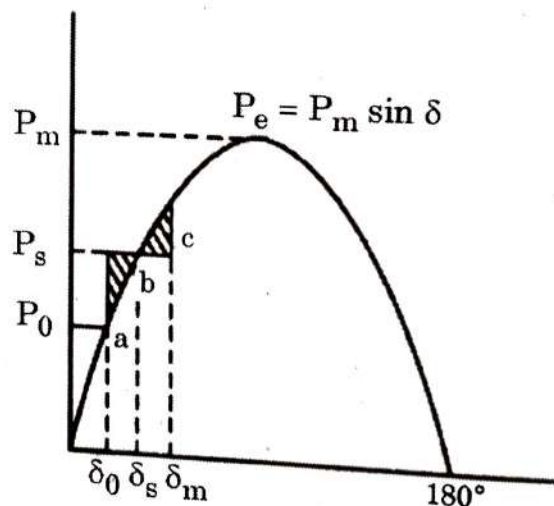

What is the condition of power at point 'b' if  $P_e$  is electromagnetic power and  $P_s$  is shaft power ?

- (a)  $P_e = P_s$
- (b)  $P_e < P_s$
- (c)  $P_e > P_s$
- (d)  $P_m = P_s$

61. Which error-time graph is relevant to the following integral mode controller output ?

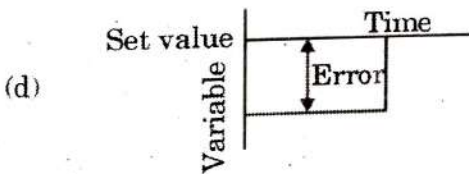
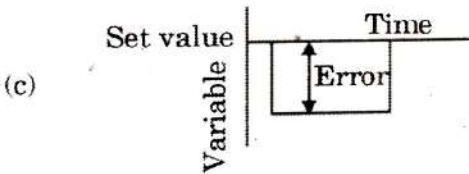
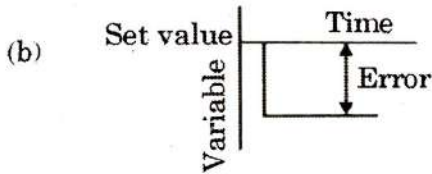
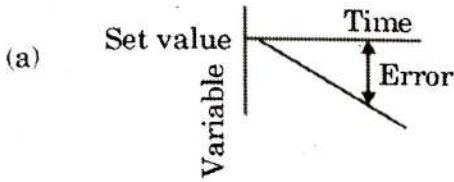
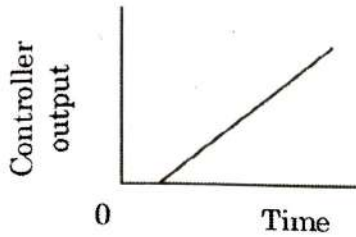

62. For the given transfer function,  $G(s) = K/(1 + Ts)$ , what is the phase of frequency response ?

- (a)  $\arctan(-\omega T)$
- (b)  $\arctan(-\omega T/2)$
- (c)  $\arctan(-2\omega T)$
- (d)  $\arctan(\omega T)$

$\frac{k}{1 + j\omega T}$   
 $-\tan^{-1}(\omega T)$

63. Which one of the following steps is correct while plotting an open-loop bode diagram ?

- (a) Transfer an open-loop TF into a constant frequency form.
- (b) For the low-frequency asymptote, if there is only the proportion link, one should plot a horizontal line with the amplitude value  $-20 \log K$  (dB).
- (c) For the high-frequency asymptote, one should change the slope of the asymptote in every break frequency  $\omega T$  for every link.
- (d) Compensate the asymptote to get the precise constant time characteristic diagram.

64. For the closed-loop transfer function as part of necessary conditions for the stability of linear feedback system, the characteristic roots must satisfy the following conditions :

1. No nil solution
2. No conjugate pure complex roots
3. All the real roots must be negative

Which of the above conditions are correct ?

- (a) 1 and 2 only
- (b) 2 and 3 only
- (c) 1 and 3 only
- (d) 1, 2 and 3

65. The Routh array of an open-loop transfer function of unit negative feedback control system is as under :

$s^3$	1	12
$s^2$	6	$8(1+k)$
$s^1$	$(32-4k)/3$	0
$s^0$	$8(1+k)$	0

The system is stable and unstable when the values of 'k' respectively are

- (a) 15 and 6
- (b) 6 and 12
- (c) 12 and 6
- (d) 6 and 15

$s^3$   
 $s^2$   
 $s^1$   
 $s^0$

$f(1+k) = 0$   
 $1+k=0$   
 $(k=-1)$

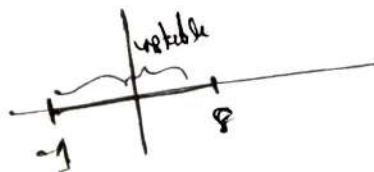

$32 - 4k = 0$   
 $4k = 32$   
 $(k=8)$

66. Consider the following table wherein three typical acceleration input signals are fed to various system types where 'R' represents the amplitude of the input (note the situation of acceleration input) and 'K' is the open-loop gain of the time constant type. What are the steady-state errors in place of A, B and C respectively in the table ?

System type	Typical input signal		
	Step	Ramp	Acceleration
	$x(t) = R$	$x(t) = Rt$	$x(t) = \frac{R}{2}t^2$
0	$\frac{R}{1+K}$	$\infty$	A
I	0	B	$\infty$
II	C	0	$\frac{R}{K}$

- (a)  $\infty$ ,  $R/K$  and 0  
 (b)  $\infty$ ,  $R/1+K$  and 0  
 (c) 0,  $R/K$  and  $\infty$   
 (d) 0,  $R/1+K$  and  $\infty$

67. Which one of the following is **not** a method to reduce steady-state error of a system ?

- (a) Increase open-loop gain  
 (b) Limiting system types  
 (c) Feed forward control  
 (d) Compound control

68. Consider the following statements related to root locus :

- The number of branches of the root locus equals the number of closed-loop poles.
- The root locus is symmetrical about the real axis.
- The root locus approaches straight lines as asymptotes as the locus approaches infinity.

Which of the above statements are correct ?

- (a) 1 and 2 only  
 (b) 2 and 3 only  
 (c) 1 and 3 only  
 (d) 1, 2 and 3

69. Consider the following visualizing lead compensation representation frequency versus gain crossover frequency :

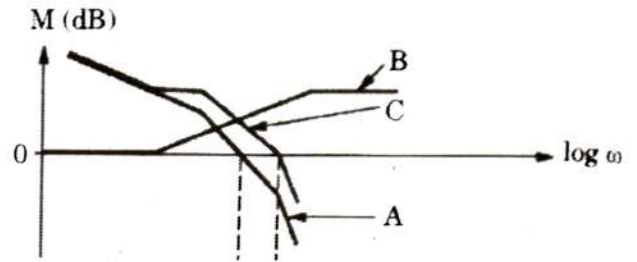

Which of the above curves is/are a compensator ?

- (a) A only  
 (b) B only  
 (c) C only  
 (d) Both A and B

70. Isolating transformers are commonly used in many types of electric circuits for the purpose of

- (a) blocking alternating current signal between the circuits  
 (b) blocking alternating current signals while maintaining direct current continuity between the circuits  
 (c) blocking direct current signals while maintaining alternating current continuity between the circuits  
 (d) blocking direct current signal between the circuits

71. When there is no ferromagnetic material but only air present in between the coils, such a transformer is called

- (a) Iron-core type transformer  
 (b) Steel-core type transformer  
 (c) Wet type transformer  
 (d) Dry type transformer

72. The objectionable audible humming sound in the core of the transformer due to magnetostriction is minimized by

- (a) decreasing flux density
- (b) increasing flux density
- (c) use of stacking laminations
- (d) use of silicon-steel sheets

73. The ideal two-winding transformer primary and secondary windings has  $N_1 = 100$  turns and  $N_2 = 200$  turns with a mutual coupling flux described by the parabolic function  $\phi_m(t) = -0.05(t^2 - 2t)$  Wb. The primary terminal voltage is

- (a)  $10(t - 1)$  Volts
- (b)  $-10(t - 1)$  Volts
- (c)  $20(t - 1)$  Volts
- (d)  $-20(t - 1)$  Volts

74. A 345-kV transmission line feeds a distribution substation that in turn has radial feeds to a 4160/2400-V, four-wire distribution network and the turns ratio of the  $\Delta - Y$  connected 100-MVA transformer in this substation. Its line current ( $I_{L1}$ ) at  $\Delta$  side is

- (a) 167.35 A
- (b) 96.62 A
- (c) 58.79 A
- (d) 138.79 A

75. A four-pole lap-wound DC machine armature has 54 slots with single-turn coils. How many armature conductors are required if there are two coil sides per slot?

- (a) 27
- (b) 54
- (c) 81
- (d) 108

76. The general solution of the system

$$6x_1 - x_2 + x_3 = 0$$

$$x_1 - x_4 + 2x_5 = 0$$

$$x_1 - 2x_5 = 0$$

is

$$(a) \quad X = \alpha \begin{pmatrix} -\frac{1}{9} \\ -\frac{2}{3} \\ 2 \\ 1 \\ 0 \end{pmatrix} + \beta \begin{pmatrix} -\frac{11}{9} \\ -\frac{13}{3} \\ 1 \\ 0 \\ 1 \end{pmatrix}$$

$$(b) \quad X = \alpha \begin{pmatrix} -\frac{1}{9} \\ -\frac{2}{3} \\ 2 \\ 1 \\ 0 \end{pmatrix} + \beta \begin{pmatrix} -\frac{11}{9} \\ -\frac{13}{3} \\ 1 \\ 0 \\ 1 \end{pmatrix} + \gamma \begin{pmatrix} -\frac{11}{9} \\ -\frac{13}{3} \\ 0 \\ \frac{1}{3} \\ 1 \end{pmatrix}$$

$$(c) \quad X = \alpha \begin{pmatrix} -\frac{1}{9} \\ -\frac{2}{3} \\ 2 \\ 1 \\ 0 \end{pmatrix} + \beta \begin{pmatrix} -\frac{11}{9} \\ -\frac{13}{3} \\ 1 \\ 0 \\ 1 \end{pmatrix} + \gamma \begin{pmatrix} -\frac{11}{9} \\ 1 \\ 0 \\ \frac{1}{3} \\ 1 \end{pmatrix}$$

$$(d) \quad X = \alpha \begin{pmatrix} -\frac{1}{9} \\ 0 \\ 2 \\ 1 \\ 0 \end{pmatrix} + \beta \begin{pmatrix} -\frac{11}{9} \\ -\frac{13}{3} \\ 1 \\ 1 \\ 1 \end{pmatrix}$$

77. If the eigenvalues of the matrix  $A = \begin{pmatrix} 5 & -2 \\ m & -6 \end{pmatrix}$  are 3 and -4, then what is the value of m?

- (a) 6
- (b) 4
- (c) 8
- (d) 9

78. If  $z = f(x + ct) + \phi(x - ct)$ , then  $\frac{\partial^2 z}{\partial t^2} =$

- (a)  $c \frac{\partial^2 z}{\partial x^2}$
- (b)  $c^2 \frac{\partial^2 z}{\partial x^2}$
- (c)  $-c^2 \frac{\partial^2 z}{\partial x^2}$
- (d)  $-c \frac{\partial^2 z}{\partial x^2}$

79. The volume of the solid enclosed between the paraboloids  $z = 5x^2 + 5y^2$  and  $z = 6 - 7x^2 - y^2$  is

- (a)  $\frac{3\pi}{2\sqrt{2}}$
- (b)  $\frac{3\pi}{\sqrt{2}}$
- (c)  $\frac{3\pi^2}{\sqrt{2}}$
- (d)  $\frac{3\pi^3}{\sqrt{2}}$

80. The Fourier series representation of  $f(x) = \begin{cases} x, & 0 \leq x \leq \pi \\ \pi, & \pi \leq x \leq 2\pi \end{cases}$  is

- (a)  $f(x) = \frac{3\pi}{4} - \frac{2}{\pi} \sum_{n=1}^{\infty} \frac{\cos(2n-1)x}{(2n-1)^2} - \sum_{n=1}^{\infty} \frac{\sin nx}{n}$  for  $0 \leq x \leq 2\pi$
- (b)  $f(x) = \frac{3\pi}{4} - \frac{2}{\pi} \sum_{n=1}^{\infty} \frac{\cos(2n-1)x}{(2n-1)^2} + \sum_{n=1}^{\infty} \frac{\sin nx}{n}$  for  $0 \leq x \leq 2\pi$
- (c)  $f(x) = \frac{3\pi}{4} - \frac{2}{\pi} \sum_{n=1}^{\infty} \frac{\cos(2n-1)x}{(2n-1)^4} - \sum_{n=1}^{\infty} \frac{\sin nx}{n}$  for  $0 \leq x \leq 2\pi$
- (d)  $f(x) = \frac{3\pi}{4} + \frac{2}{\pi} \sum_{n=1}^{\infty} \frac{\cos(2n-1)x}{(2n-1)^2} - \sum_{n=1}^{\infty} \frac{\sin nx}{n}$  for  $0 \leq x \leq 2\pi$

81. The value of  $\oint_{\gamma} e^{1/z} dz$  where  $\gamma$  is a closed path enclosing the origin is

- (a)  $-2\pi i$
- (b)  $2\pi i$
- (c)  $-\pi i$
- (d)  $\pi i$

82. Let  $f(z) = 2iz + 6\bar{z}$ . The value of f at  $z = \frac{1}{2} + 4i$  is

- (a)  $5 - 23i$
- (b)  $5 + 23i$
- (c)  $-5 - 23i$
- (d)  $-5 + 23i$

Handwritten solution for Q82:  
 $2i + 6\left(\frac{1}{2} + 4i\right)$   
 $2i + 3 + 24i$   
 $2i\left(\frac{1}{2} + 4i\right) + 3 + 24i$   
 $[3 + 3 + 24i]$   
 $= 5 + 23i$



83. What is the root of the equation  $x \sin x + \cos x = 0$  up to four decimal places?

- (a) 2.7689
- (b) 2.7784
- (c) 2.7498
- (d) 2.7984

$a \sin x + b \cos x + c = 0$   
 $c + \sqrt{a^2 + b^2}$   
 $\sqrt{x^2 + 1}$

84. Which one of the following is the general integral of the linear partial differential equation  $(y + xz)p - (x + yz)q = (x^2 - y^2)$ ?

- (a)  $F(x^2 + y^2 - z^2, xy + z) = 0$
- (b)  $F(x^2 - y^2 - z^2, xz + y) = 0$
- (c)  $F(x^2 + y^2 - z^2, xz + y) = 0$
- (d)  $F(x^2 + y^2 - z^2, zy + x) = 0$

85. Suppose the random variable  $X$  has distribution function

$$F(x) = \begin{cases} 0 & x \leq 0 \\ 1 - \exp(-x^2) & x > 0 \end{cases}$$

What is the probability that  $X$  exceeds 1?

- (a)  $e^{-2}$
- (b)  $e^{-1}$
- (c)  $e^{-3}$
- (d)  $e^{-4}$

86. A total of 28 percent of American males smoke cigarettes, 7 percent smoke cigars, and 5 percent smoke both cigars and cigarettes. What percentage of males smoke neither cigars nor cigarettes?

- (a) 30 percent
- (b) 20 percent
- (c) 80 percent
- (d) 70 percent

28% → cigaret  
 7% → cigar  
 5% → cig. & cigar

87. If the average number of claims handled daily by an insurance company is 5, what proportion of days have less than 3 claims? Assume that the number of claims on different days is independent.

- (a)  $\frac{37e^{-5}}{2}$
- (b)  $\frac{31e^{-5}}{2}$
- (c)  $\frac{35e^{-5}}{2}$
- (d)  $\frac{39e^{-5}}{2}$

88. A negative feedback system has a forward path gain of 18 and a feedback path gain of 0.15. What is the overall gain of the system?

- (a) 4.86
- (b) 10.66
- (c) 3.26
- (d) 2.86

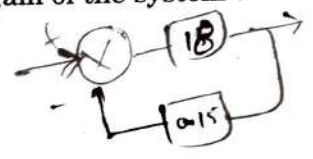

89. Consider the following conditions for a second order system when subject to a unit step input:

1. With critical damping, there are no oscillations.
2. With no damping, the system output oscillates with constant frequency and variable amplitude.
3. With overdamping, the output takes longer time to reach the steady-state value.

Which of the above conditions is/are **not** correct?

- (a) 2 and 3 only
- (b) 1 only
- (c) 2 only
- (d) 1 and 3 only

9 + 18 x 15  
 + 100  
 50

90. In Nyquist stability criterion, the closed-loop systems whose open-loop frequency response  $G(j\omega)H(j\omega)$  loci, as  $\omega$  goes from 0 to  $\infty$ , do not encircle the  $-1$  point, will be

- (a) unstable
- (b) marginally stable
- (c) marginally unstable
- (d) stable

2.  
 135  
 50

91. Consider the following statements regarding FET amplifier configurations :
1. For common-source and common-drain configurations,  $R_{in} = R_1 || R_2$ , which can be selected to be large during bias design.
  2. For the common-drain configuration, the voltage gain is generally less than unity or near unity.
  3. For the common-gate configuration, the current gain cannot be larger than unity.
- Which of the above statements is/are correct ?
- (a) 1 only
  - (b) 1 and 2 only
  - (c) 2 and 3 only
  - (d) 1, 2 and 3
92. An amplifier has a bandwidth of 500 kHz and voltage gain of 100. What is the amount of negative feedback if the bandwidth is extended to 5 MHz ?
- (a) 9.0
  - (b) 0.9
  - (c) 0.09
  - (d) 0.009
93. An amplifier has an open loop voltage gain of 1000. If 10% negative voltage series feedback is used, what is the closed loop voltage gain ?
- (a) 0.19
  - (b) 1.9
  - (c) 9.9
  - (d) 0.99
94. Which one of the following quantities is a material parameter ?
- (a) Peridynamic lattice
  - (b) Electrical elongation
  - (c) Thermal elongation
  - (d) Electrical conductivity
95. The property of periodicity in crystal structure is repeated in three dimensions. The positive ions occupy the corners of a cube as well as the centres of the cubic face. Then these crystals are called
- (a) Face-centered cubic crystals
  - (b) Body-centered cubic crystals
  - (c) Halite-centered cubic crystals
  - (d) Rock-salt-centered cubic crystals
96. The electrical conductivity depends on
- (a) the volume concentration of the holes and on their mobility
  - (b) the volume concentration of the electrons of conduction and on their mobility
  - (c) concentration of both electrons and protons
  - (d) concentration of electrons only
97. The classical theory of the diamagnetism of the bonded electrons in a free atom was elaborated by
- (a) Langevin diamagnetism
  - (b) Larmor diamagnetism
  - (c) Lorentz diamagnetism
  - (d) Thomson diamagnetism
98. Which one of the following is the process of heating a material to just below its melting point ?
- (a) Sinter
  - (b) Squid
  - (c) Josephson junction
  - (d) Stripes
99. Which of the following are the mixtures of materials used for the sliding contacts which appear between the trolley and the trolley cable in the electrical traction of high braking power ?
- (a) Silver, Electrolytic copper, Lead with Zinc and Aluminium
  - (b) Silver, Copper, Bronze with Beryllium and Cadmium
  - (c) Silver, Copper, Lead with Zinc and Gold
  - (d) Silver, Electrolytic copper, Bronze with Zinc and Gold

100. Which one of the following is the element exhibiting antiferromagnetism at room temperature ?
- Iron
  - Nickel
  - Chromium
  - Cobalt
101. Electro-optic devices that emit radiations of different colours are called
- Opto-couplings
  - Photoresistors
  - Light emitting diodes
  - Void generators
102. The phenomenon where superconductivity in a material is suppressed by exceeding the maximum current the material can conduct ( $J_c$ ) or the maximum magnetic field it can withstand ( $H_c$ ) is called
- Sinter
  - Quench
  - Stripes
  - Proximity effect
103. Which one of the following corresponds to the variation of the rotation frequency of the electron when the external field is applied ?
- Langevin frequency
  - Lorentz frequency
  - Thomson frequency
  - Larmor frequency
104. Which one of the following agents is an intrinsic agent that influences conductivity in electro insulating materials ?
- Humidity
  - The nature of the dielectric
  - Temperature
  - Pressure
105. A semiconductor indium phosphide material behaves as an insulator at
- high temperature
  - medium temperature
  - normal room temperature
  - very low temperature
106. Which one of the following statements is correct for atomic data ?
- Aggregation of atomic and composite data into a set with defined relationships are validated.
  - Heterogeneous combination of data into a single structure with an identified key is validated.
  - Homogeneous combination of data into a single structure with an identified key is validated.
  - It is a data that consists of a single piece of information; that is, they cannot be divided into other meaningful pieces of data.
107. Consider the four processes  $P_1 = 6$ ,  $P_2 = 8$ ,  $P_3 = 7$ , and  $P_4 = 3$  with the length of the CPU burst time given in milliseconds and all four processes arrive at time 0. What is the average waiting time for these processes with the shortest job first algorithm ?
- 5 ms
  - 7 ms
  - 9 ms
  - 11 ms
108. The processes that are residing in main memory and are ready and waiting to execute are kept on a list called the ready queue. Then, this queue is generally stored as
- a double ended queue
  - a priority queue
  - a linked list
  - a double ended list
109. When a process creates a new process using the fork() operation, which one of the following states is shared between the parent process and the child process ?
- Stack
  - Heap
  - Linked list
  - Shared memory segments

110. Consider the following statements regarding thread pool :

1. It is to create a number of threads at process startup and place them into a pool, where they sit and wait for work.
2. A thread pool limits the number of threads that exist at any one point and this is particularly important on systems that cannot support a large number of concurrent threads.
3. Once the summation thread is created, the parent must wait for it to complete before outputting the value of sum, as the value is set by the summation thread.
4. It allocates memory and initializes a new thread in the JVM.

Which of the above statements are correct ?

- (a) 1 and 2 only
- (b) 3 and 4 only
- (c) 1 and 3 only
- (d) 1, 2, 3 and 4

111. Which one of the following is used for recognizing the magnetic encoding numbers printed at the bottom of a cheque ?

- (a) Optical Mark Recognition
- (b) Magnetic Ink Character Recognition
- (c) Barcode Reader
- (d) Optical Character Recognition

112. Consider the following statements regarding biasing of p-n junction :

1. The depletion layer width gets narrowed down on application of forward voltage.
2. A forward-biased p-n junction offers very high resistance to current flow.
3. The barrier potential increases when the junction is reverse-biased.
4. Majority charge carrier's current is established in a forward-biased p-n junction.

Which of the above statements are correct ?

- (a) 1, 2, 3 and 4
- (b) 2, 3 and 4 only
- (c) 1, 3 and 4 only
- (d) 3 and 4 only

113. Which one of the following is the correct representation of Boltzmann diode equation with standard notations ? (where  $I$  is the diode current,  $V$  is the bias voltage, and  $V_T$  is the thermal voltage)

$$(a) \quad I = I_0 \left( e^{\frac{V}{\eta V_T}} - 1 \right)$$

$$(b) \quad I = I_0 \left( e^{\frac{V}{\eta V_T}} + 1 \right)$$

$$(c) \quad I = I_0 \left( e^{-\frac{V}{\eta V_T}} - 1 \right)$$

$$(d) \quad I = I_0 \left( e^{-\frac{V}{\eta V_T}} + 1 \right)$$

114. The common emitter configuration is widely used due to its

- (a) low voltage and low power gain
- (b) low voltage and high power gain
- (c) high voltage and high power gain
- (d) high voltage and low power gain

115. A silicon diode made half-wave rectifier produces a maximum value of load current as 20 mA through a resistance of 1 k $\Omega$ . What is the PIV of the diode ?

- (a) 14.7 V
- (b) 16.7 V
- (c) 18.7 V
- (d) 20.7 V

116. Ripple factor for a half-wave and a full-wave rectifier circuits respectively are

- (a) 0.48 and 1.21
- (b) 0.37 and 2.12
- (c) 1.21 and 0.48
- (d) 2.12 and 0.37

117. If a transistor has the value of common base current gain 0.98, then what is the value of common emitter current gain ?

- (a) 48
- (b) 49
- (c) 50
- (d) 51

118. The junction FET is a three terminal

- (a) voltage controlled voltage device
- (b) current controlled voltage device
- (c) voltage controlled current device
- (d) current controlled current device

119. Consider the basic MOSFET circuit as shown in the figure with variable gate voltage. The MOSFET is given to have very large  $V_A$ ,  $V_T = 4$  V, and  $I_{DSS} = 8$  mA. What is the value of  $i_D$  for  $v_{GS} = 5$  V ? (Where  $V_A$  is a constant in the range of 30 V to 200 V)

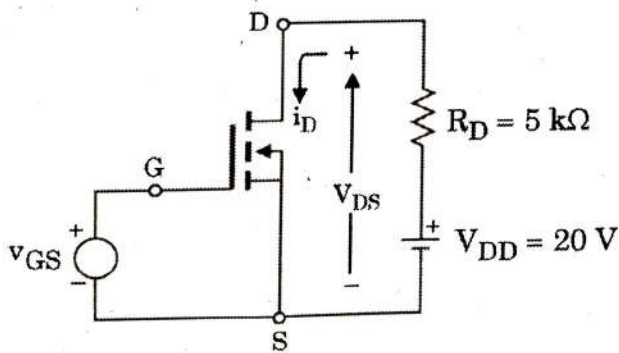

- (a) 0.2 mA
- (b) 0.5 mA
- (c) 1.0 mA
- (d) 2.0 mA

120. Which one of the following is the correct circuit symbol representation of p-channel JFET ?

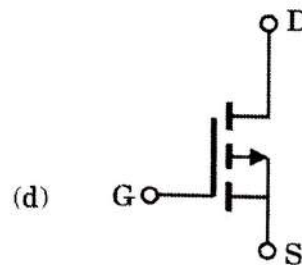
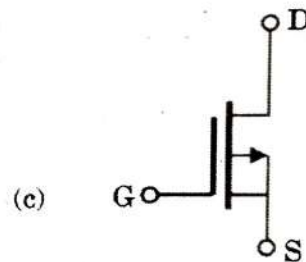
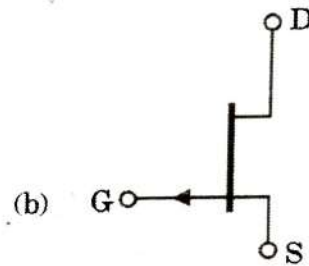
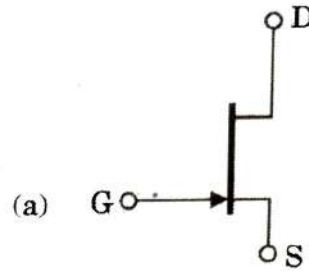

$$\frac{0.98}{0.02} = 49$$

$$\frac{98}{2}$$

121. A simple slide wire is used for measurement of current in a circuit. The voltage drop across a standard resistor of  $0.1 \Omega$  is balanced at 75 cm. What is the magnitude of current in the circuit if the standard cell emf of 1.45 V is balanced at 50 cm ?

- (a) 21.75 A
- (b) 10.87 A
- (c) 9.66 A
- (d) 4.83 A

122. Which one of the following methods is *not* used in measurement of high resistance ?

- (a) Direct deflection method
- (b) Megohm bridge method
- (c) Megger method
- (d) Kelvin double bridge method

123. Which one of the following is intended for the rapid measurement of the winding resistances of machines and transformers ?

- (a) Direct deflection
- (b) Wheatstone bridge
- (c) Megger
- (d) Kelvin bridge ohmmeter

124. A highly sensitive galvanometer can detect a current as low as  $0.1 \text{ nA}$ . This galvanometer is used in a Wheatstone bridge as a detector. Each arm of the bridge has a resistance of  $1 \text{ k}\Omega$ . The input voltage applied to the bridge is 20 V. What is the smallest change in resistance which can be detected, if the resistance of the galvanometer can be neglected compared to the internal resistance of the bridge ?

- (a)  $10 \text{ m}\Omega$
- (b)  $10 \mu\Omega$
- (c)  $20 \text{ m}\Omega$
- (d)  $20 \mu\Omega$

125. Which one of the following methods is *not* used in measurement of low resistance ?

- (a) Direct deflection method
- (b) Ammeter voltmeter method
- (c) Potentiometer method
- (d) Kelvin double bridge method

126. A regular Wheatstone bridge is used to measure high resistance. The bridge has ratio arms of  $10,000 \Omega$  and  $10 \Omega$ . The adjustable arm has a maximum value of  $10,000 \Omega$ . A battery of 10 V emf and negligible resistance is connected from the junction of ratio arms to the opposite corner. What is the maximum resistance that can be measured by this arrangement ?

- (a)  $10 \text{ k}\Omega$
- (b)  $10 \text{ M}\Omega$
- (c)  $100 \text{ k}\Omega$
- (d)  $100 \text{ M}\Omega$

127. A resistance of approximately  $3000 \Omega$  is needed to balance a bridge. It is obtained on a 5 dial resistance box having steps of  $1000 \Omega$ ,  $100 \Omega$ ,  $10 \Omega$ ,  $1 \Omega$  and  $0.1 \Omega$ . The measurement is to be guaranteed to 0.1 percent. For this accuracy, how many of these dials would it be worth to adjust ?

- (a)  $2997 \Omega$  to  $3003 \Omega$
- (b)  $3000 \Omega$  to  $3006 \Omega$
- (c)  $2994 \Omega$  to  $3000 \Omega$
- (d)  $2996 \Omega$  to  $3002 \Omega$

128. Consider the following statements :

1. Campbell's bridge measures an unknown mutual inductance in terms of a standard mutual inductance.
2. Campbell's bridge is used for measurement of self-inductance in terms of a standard mutual inductance.

Which of the above statements is/are correct ?

- (a) 1 only
- (b) 2 only
- (c) Both 1 and 2
- (d) Neither 1 nor 2

129. Consider the following statements :
- Carey Foster bridge is used for measurement of capacitance in terms of a standard mutual inductance.
  - Heydweiller bridge is used for measurement of mutual inductance in terms of a standard mutual inductance.

Which of the above statements is/are correct ?

- 1 only
  - 2 only
  - Both 1 and 2
  - Neither 1 nor 2
130. A benchmark program is run on a 200 MHz processor. The executed program consists of 1 million instruction executions, with the following instruction mix and clock cycle count :

Instruction Type	Instruction Count (Millions)	Cycles per Instruction
Arithmetic and logic	8	1
Load and store	4	3
Branch	2	4
Others	4	3

What is the effective MIPS rate for the given program ?

- 90
  - 70
  - 110
  - 80
131. What is the exponent length in bits for IEEE double-precision floating point format ?
- 32 bits
  - 8 bits
  - 16 bits
  - 11 bits
132. Which one of the following instruction formats is designed to be a large-scale time-shared system, with an emphasis on making the system easy to program, even if additional hardware expense was involved ?
- PDP-8
  - PDP-10
  - PDP-6
  - PDP-12

133. Which one of the following statements is correct for machine parallelism ?

- It is a measure of the ability of the processor to take disadvantage of instruction-level parallelism.
- It is determined by the frequency of true data dependencies and procedural dependencies in the code.
- It is determined by the number of instructions that can be fetched and executed at the same time and by the speed and sophistication of the mechanisms that the processor uses to find independent instructions.
- It is determined by the time until the result of an instruction is available for use as an operand in a subsequent instruction.

134. Consider a main memory consisting of 4 K blocks, a cache memory consisting of 64 blocks, and a block size of 32 words. Compute the number of bits in the main memory address using direct-mapped cache technique.

- 16
- 17
- 19
- 14

135. Which one the following methods is used when the processor issues an I/O command, continues to execute other instructions, and is interrupted by the I/O module when the latter has completed its work ?

- Interrupt-driven I/O
- I/O device controller
- I/O channel processor controller
- Programmed I/O

136. A small region of an impure silicon crystal with dimensions  $1.25 \times 10^{-6} \text{ m} \times 10^{-3} \text{ m} \times 10^{-3} \text{ m}$  has only the ions (with charge  $+1.6 \times 10^{-19} \text{ C}$ ) present with a volume density of  $10^{25}/\text{m}^3$ . The rest of the crystal volume contains equal densities of electrons (with charge  $-1.6 \times 10^{-19} \text{ C}$ ) and positive ions. The net total charge of the crystal is

- (a)  $3 \times 10^{-6} \text{ C}$
- (b)  $1 \times 10^{-6} \text{ C}$
- (c)  $1.5 \times 10^{-6} \text{ C}$
- (d)  $2 \times 10^{-6} \text{ C}$

137. The current wave form is shown in the figure below. What is the average value over the time interval of 1 to 7 seconds?

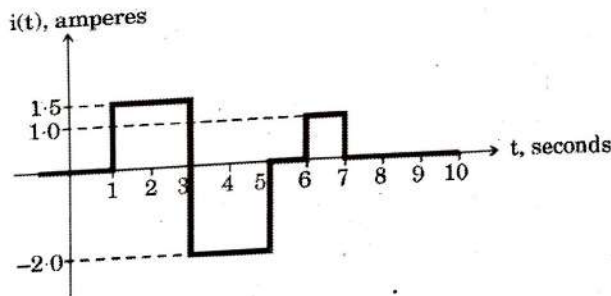

- (a) 5.5 A
- (b) 1.5 A
- (c) 0 A
- (d) 2.5 A

138. What are the unknown currents  $i_5$  and  $i_3$  respectively for the circuit shown in the figure below?

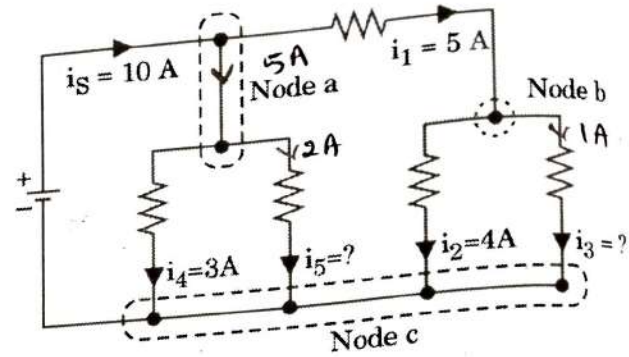

- (a) 2 A and 1 A
- (b) 1 A and 2 A
- (c) 18 A and 9 A
- (d) 9 A and 18 A

139. What is the current delivered by the 10 V source in the circuit shown below?

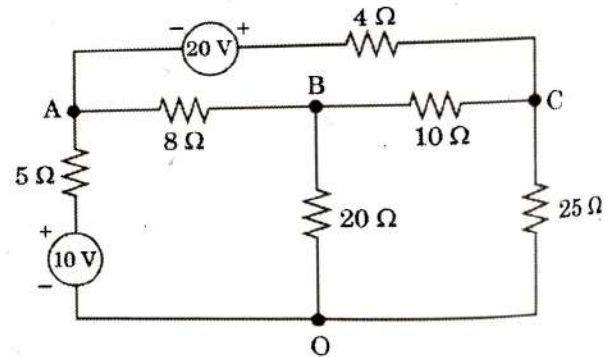

- (a) 2.132 A
- (b) 3.132 A
- (c) 1.132 A
- (d) 0.532 A



140. The following circuit shown in the figure has a voltage source and a dependent current source. What is the Thevenin equivalent resistance at terminals a - b?

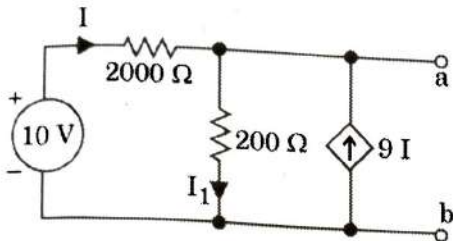

- (a) 10 Ω
- (b) 20 Ω
- (c) 100 Ω
- (d) 200 Ω

$100 \times 10^{-6}$   
 $10^{-4}$   
 $t = 50 \mu s$   
 $5 \times 10^{-6} \times 10 \times 10^3$   
 $100$   
 $50 \times 10^{-6}$

142. In the circuit of the figure shown below, the source voltage is 100 V, the resistance is 10 kΩ, and the capacitance is 0.005 μF. In how much time can the capacitor voltage be discharged to 5 V after the switch is turned to position 3?

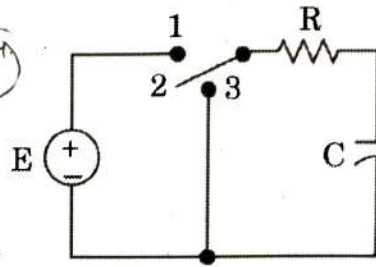

- (a) 50 μs
- (b) 50 ms
- (c) 150 ms
- (d) 150 μs

$\ln\left(\frac{50}{100}\right)$   
 $\ln 50 - \ln 100$   
 $\ln 50 - 3$   
 $\ln(5) + \ln(10)$   
 $= 5 \cdot 2$   
 $t = \tau \ln\left(\frac{V}{V_0}\right)$   
 $t = \frac{R \cdot C}{e} \ln\left(\frac{V}{V_0}\right)$   
 $t = \frac{10 \times 10^3 \times 0.005 \times 10^{-6}}{e} \ln\left(\frac{50}{100}\right)$   
 $t = \frac{50 \times 10^{-3}}{e} \ln(0.5)$   
 $t = \frac{50 \times 10^{-3}}{2.3} \times 0.693$   
 $t = \frac{12 \times 17}{24} = \frac{12}{204}$

141. An experimental circuit as shown in the figure below has the variable resistor  $R_L$  which is adjusted to the value of the load resistor as 10 Ω. What is the maximum load power?

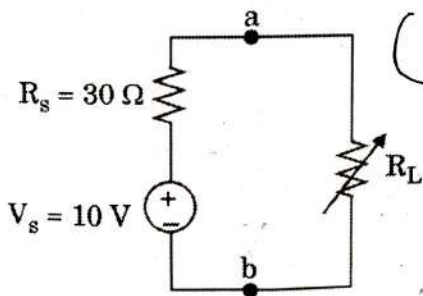

- (a) 981 mW
- (b) 816 mW
- (c) 733 mW
- (d) 625 mW

$\left(\frac{10}{30}\right)^2 \times 10$   
 $\frac{1}{1600} \times 10$   
 $\frac{1}{16} \times \frac{1000}{1000}$   
 $\frac{1000}{160} \text{ m}$   
 $\left(\frac{10}{40}\right)^2 \times 10$   
 $\frac{100}{1600}$   
 $\frac{100 \times 1000}{120 \times 1000}$   
 $\frac{100 \times 1000}{120}$   
 $\frac{1000}{120}$   
 $\frac{83}{5000}$   
 $\frac{120 \times 17}{24} = \frac{12}{204}$   
 $3 \times \frac{20k \times 10 \times 0.6}{\sqrt{3}}$   
 $\sqrt{3} \times 20k \times 10 \times 0.6$   
 $\frac{10 \times 1000}{16} \times \frac{1000}{1000} \times 20k \times \sqrt{3}$   
 $\frac{10 \times 1000}{16} \times 20k \times 1.732$   
 $\frac{625}{10,000}$   
 $\frac{120}{16}$   
 $120 \times$

143. A wye-connected generator is to be designed to supply a 20-kV three-phase line and supply a line current of 10 A at a lagging power factor of 0.8. How much reactive power (kVAR) should be supplied by the wye-connected generator?

- (a) 200.4 kVAR
- (b) 207.84 kVAR
- (c) 277.12 kVAR
- (d) 346.4 kVAR

$\frac{120 \times 17}{24} = \frac{12}{204}$   
 $3 \times \frac{20k \times 10 \times 0.6}{\sqrt{3}}$   
 $\sqrt{3} \times 20k \times 10 \times 0.6$   
 $\frac{10 \times 1000}{16} \times \frac{1000}{1000} \times 20k \times \sqrt{3}$   
 $\frac{10 \times 1000}{16} \times 20k \times 1.732$   
 $\frac{625}{10,000}$   
 $\frac{120}{16}$   
 $120 \times$

144. A cross-sectional view of a Printed Circuit Board (PCB) consisting of two conducting lands on the surface of a dielectric board above a reference ground plane is shown in the figure. The three-conductor system characterized by a partial capacitance scheme is also shown. For the multiple conductor system, what is the capacitance matrix  $[C]$  ?

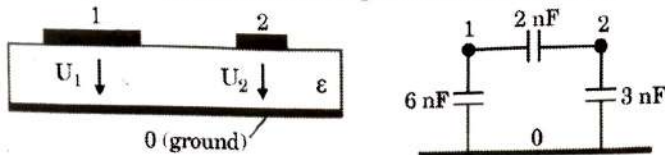

- (a)  $[C] = \begin{bmatrix} -2 & 8 \\ 5 & -2 \end{bmatrix} \text{ nF}$
- (b)  $[C] = \begin{bmatrix} -2 & 5 \\ 8 & -2 \end{bmatrix} \text{ nF}$
- (c)  $[C] = \begin{bmatrix} 2 & -8 \\ -5 & 2 \end{bmatrix} \text{ nF}$
- (d)  $[C] = \begin{bmatrix} 8 & -2 \\ -2 & 5 \end{bmatrix} \text{ nF}$

145. The two wattmeter method produces wattmeter readings  $P_1 = 1500 \text{ W}$  and  $P_2 = 2500 \text{ W}$  when connected to a delta-connected load. What is the per-phase reactive power if the line voltage is  $220 \text{ V}$  ?
- (a)  $3117 \text{ VAR}$
- (b)  $311.7 \text{ VAR}$
- (c)  $577.3 \text{ VAR}$
- (d)  $5773 \text{ VAR}$

146. A three-phase balanced star-connected motor draws a real power of  $5.6 \text{ kW}$  from the line voltage of  $220 \text{ V}$  and the line current of  $18.2 \text{ A}$ . What is the approximate power factor of this motor ?
- (a)  $0.6075$
- (b)  $0.8075$
- (c)  $0.4075$
- (d)  $0.2075$

147. A circuit composed with series combination of sinusoidal voltage source  $V_s = 3 \cos(100t - 3^\circ) \text{ V}$ , a  $500 \Omega$  resistor, a  $30 \text{ mH}$  inductor and an unknown impedance. What is the value of unknown impedance ( $Z_L$ ) if the voltage source delivers maximum average power ?
- (a)  $500 - j30 \Omega$
- (b)  $500 + j30 \Omega$
- (c)  $500 - j3 \Omega$
- (d)  $500 + j3 \Omega$

148. Which one of the following is used to protect the standard cell and galvanometer against over currents ?
- (a) A pressure coil in series
- (b) A current coil in parallel
- (c) A resistance in series
- (d) A resistance in parallel

149. In the measurement of a low resistance using a potentiometer, voltage drop across the low resistance under test is  $0.4 \text{ V}$ , voltage drop across  $0.1 \Omega$  standard resistance is  $1 \text{ V}$ . What is the power loss in unknown resistance ?
- (a)  $0.04 \text{ W}$
- (b)  $0.4 \text{ W}$
- (c)  $4 \text{ W}$
- (d)  $40 \text{ W}$

150. Consider the following statements :
- Potentiometer is the usual basis for calibration of voltmeters, ammeters and wattmeters.
  - The potentiometers may not be used for measurement of current, power and resistance.
- Which of the above statements is/are correct ?
- (a) 1 only
- (b) 2 only
- (c) Both 1 and 2
- (d) Neither 1 nor 2