



**Delhi Development Authority
(Recruitment Cell)**
Advertisement No. 03/2022/Rectt.Cell./Pers./DDA

Participant ID	
Participant Name	
Test Center Name	
Test Date	28/03/2023
Test Time	4:30 PM - 6:30 PM
Subject	Junior Engineer (Civil)

Section : Domain Questions

Q.1 As per IS 10262:2019, the volume of the coarse aggregate per unit volume of the total aggregate for water to cementitious materials ratio of 0.50 ranges from _____ when the nominal size of the coarse aggregate is 20 mm.

- Ans
- 1. 0.66 to 0.72
 - 2. 0.6 to 0.66
 - 3. 0.69 to 0.73
 - 4. 0.48 to 0.54

Question ID : 630680196865
Status : Answered
Chosen Option : 1

Q.2 Consider below statements with respect to the compaction of soil and identify the correct answer.

Statement A: Fine-grained soils attain a much higher density and lower optimum _____ content when compared with well-graded coarse-grained soils.

Statement B: The compacted density of soil increases as water content _____ till a maximum dry density is achieved.

- Ans
- 1. Both statements are correct.
 - 2. Statement B is correct, and statement A is incorrect.
 - 3. Both statements are incorrect.
 - 4. Statement A is correct, and statement B is incorrect.

Question ID : 630680196875
Status : Answered
Chosen Option : 1

Q.3 In plate girders, the intermediate vertical stiffeners are provided to _____.

- Ans
- 1. eliminate web buckling
 - 2. eliminate flange crippling
 - 3. connect extra plate with flanges
 - 4. connect the two members

Question ID : 630680196904
Status : Answered
Chosen Option : 4

Q.4 Consider the below statements with respect to the types of fluid flow and identify the INCORRECT statement.

Ans 1.

Fluid particles move along well-defined paths or stream line in the laminar flow.

2.

Fluid character 'pressure' at a point in steady flow does not change with time.

3.

Reynolds number is used to classify the types of flow, whether laminar or turbulent.

4.

The velocity at any given time changes with respect to space in a uniform flow.

Question ID : 630680196884

Status : Answered

Chosen Option : 4

Q.5 Identify the INCORRECT statement with respect to the constituents of glass.

Ans 1. Lime imparts colour, brightness and shine to glass.

2.

Potash renders glass infusible and makes the glass fire resistant.

3. Soda acts as an accelerator for the fusion of glass.

4.

Cullets are broken glasses added to act as flux to prevent the loss of alkali by volatilisation.

Question ID : 630680196842

Status : Answered

Chosen Option : 1

Q.6 Calculate the theoretical velocity of the jet at vena contracta of an orifice if the head of water over the orifice is 20 m.

Consider the acceleration due to gravity to be 10 m/s^2 .

Ans 1. 10 m/s

2. 25 m/s

3. 12.5 m/s

4. 20 m/s

Question ID : 630680196880

Status : Not Answered

Chosen Option : --

Q.7 The decomposition of felled timber due to the action of various fungi is called _____.

Ans 1. rind gall

2. heart shake

3. charring

4. dry rot

Question ID : 630680196839

Status : Answered

Chosen Option : 1

Q.8 Which of the following is NOT the assumption made in the analysis of trusses?

- Ans
- 1. The members of truss are straight.
 - 2. All the members of truss are pin jointed members.
 - 3. All the members of truss are flexible.
 - 4. Forces are acting only on joints.

Question ID : 630680196902
Status : Answered
Chosen Option : 3

Q.9 According to the Indian Standard Soil Classification System, the basic soil components 'sand' and 'silt' are symbolised with letters _____, respectively.

- Ans
- 1. S and M
 - 2. M and S
 - 3. S and S
 - 4. S and O

Question ID : 630680196871
Status : Answered
Chosen Option : 1

Q.10 A rectangular strut with cross-sectional area $18,000 \text{ mm}^2$ is subjected to a point load (180 kN) at an eccentricity 10mm in a plane bisecting the thickness as shown in the figure. Calculate the maximum intensity of bending stress in the section.

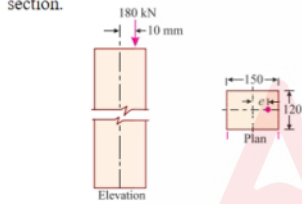

- Ans
- 1. 4 MPa
 - 2. 2.5 MPa
 - 3. 5.2 MPa
 - 4. 2 MPa

Question ID : 630680196893
Status : Not Answered
Chosen Option : --

Q.11 In particle size distribution curve drawn for a soil sample, the effective diameter is represented by:

- Ans
- 1. D50
 - 2. D20
 - 3. D30
 - 4. D10

Question ID : 630680196876
Status : Answered
Chosen Option : 4

Q.12 A rectangular open channel of width 4 m and depth 2 m is having a bed slope of 1 in 900. What is the maximum discharge through the channel if Chezy's constant $C = 50$?

- Ans**
- 1. $13.33 \text{ m}^3/\text{s}$
 - 2. $19.73 \text{ m}^3/\text{s}$
 - 3. $22.44 \text{ m}^3/\text{s}$
 - 4. $8.56 \text{ m}^3/\text{s}$

Question ID : **630680196883**
Status : **Not Answered**
Chosen Option : --

Q.13 The abrasion value of aggregates, when tested in accordance with the method specified in IS:2386. aggregates to be used in other than concrete, abrasion value of aggregates should NOT be more than:

- Ans**
- 1. 30%
 - 2. 10%
 - 3. 20%
 - 4. 50%

Question ID : **630680196837**
Status : **Answered**
Chosen Option : 2

Q.14 Identify the INCORRECT statement with respect to a type of stone 'Kankar'.

- Ans**
- 1. Kankar is irregular in shape.
 - 2. Kankar has a porous structure.
 - 3. Kankar is a type of metamorphic rock.
 - 4. Nodular Kankar is used to produce hydraulic lime.

Question ID : **630680196834**
Status : **Answered**
Chosen Option : 2

Q.15 In the case of Portland Pozzolana cement, which of the following products of hydration of cement is involved in secondary hydration with pozzolanic materials?

- Ans**
- 1. Calcium silicate
 - 2. Calcium carbonate
 - 3. Calcium hydroxide
 - 4. Calcium aluminate

Question ID : **630680196861**
Status : **Answered**
Chosen Option : 1

Q.16 In steel structures, the splices used in compression members are designed as _____.

- Ans
- 1. short columns
 - 2. battens
 - 3. slender columns
 - 4. per the thickness of splice

Question ID : 630680196903
Status : Answered
Chosen Option : 4

Q.17 As per IS 456:2000, the maximum free water cement ratio of concrete with normal weight aggregates of 20 mm nominal maximum size to be used in RCC structures at mild exposure condition is _____.

- Ans
- 1. 0.55
 - 2. 0.4
 - 3. 0.50
 - 4. 0.60

Question ID : 630680196862
Status : Answered
Chosen Option : 3

Q.18 As per IS 456:2000, the theoretical value of the effective length of a compression member that is effectively held in position and restrained against rotation at both ends is _____ times the unsupported length of the compression member.

- Ans
- 1. 1.5
 - 2. 1.2
 - 3. 0.5
 - 4. 0.8

Question ID : 630680196895
Status : Answered
Chosen Option : 2

Q.19 Consider the below statements with respect to the physical properties of stones and identify the correct answer.

Statement A: Splitting of stone minerals along the planes parallel to crystal faces is called cleavage.

Statement B: The colour of stone mineral in powdered form is called lustre.

- Ans
- 1. Statement B is correct, and statement A is incorrect.
 - 2. Both statements are correct.
 - 3. Both statements are incorrect.
 - 4. Statement A is correct, and statement B is incorrect.

Question ID : 630680196835
Status : Answered
Chosen Option : 2

Q.20 Which of the following expressions is correct to calculate the limiting moment of resistance in accordance with the limit state design of a singly reinforced rectangular beam? Consider that the grade of steel is Fe500, f_{ck} = characteristic compressive strength of concrete, b is the width of beam and d is the effective depth of beam.

Ans

- ✓ 1. $M_{u, \text{lim}} = 0.1338f_{ck}bd^2$
- ✗ 2. $M_{u, \text{lim}} = 0.1498f_{ck}bd^2$
- ✗ 3. $M_{u, \text{lim}} = 0.1573f_{ck}bd^2$
- ✗ 4. $M_{u, \text{lim}} = 0.1389f_{ck}bd^2$

Question ID : 630680196899

Status : Answered

Chosen Option : 2

Q.21 Identify the '6' in the given figure of a Dumpy Level.

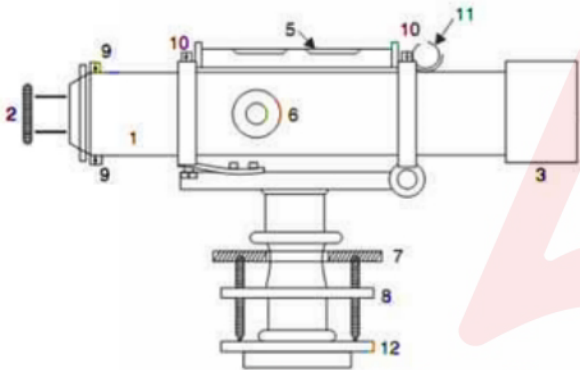

Ans

- ✗ 1. Bubble Tube Adjusting Screw
- ✗ 2. Diaphragm Adjusting Screw
- ✗ 3. Foot Screw
- ✓ 4. Focusing Screw

Question ID : 630680196851

Status : Answered

Chosen Option : 4

Q.22 As per IS standards, the height to diameter ratio of a cylindrical concrete specimen shall be ____ to find its compressive strength.

Ans

- ✗ 1. 3.0
- ✗ 2. 1
- ✓ 3. 2.0
- ✗ 4. 1.5

Question ID : 630680196866

Status : Answered

Chosen Option : 4

Q.23 As per IS 456:2000, the bending moment coefficient to calculate the span moment of one way continuous slab, near the middle of end span is _____. Consider that the slab is subjected to dead load and imposed load (fixed).

Ans

- 1. $+\frac{1}{9}$
- 2. $+\frac{1}{12}$
- 3. $+\frac{1}{10}$
- 4. $+\frac{1}{16}$

Question ID : 630680196900

Status : Answered

Chosen Option : 2

Q.24 A cantilever beam with a rectangular cross-section has a section modulus of $192 \times 10^3 \text{ mm}^3$ as shown in the figure. If the cantilever is subjected to a point load of 6 kN at the free end and the bending stress is not to exceed 50 MPa, find the span of the cantilever beam.



Ans

- 1. 1.6 m
- 2. 2.4 m
- 3. 0.8 m
- 4. 1.2 m

Question ID : 630680196855

Status : Not Answered

Chosen Option : --

Q.25 The ratio of dynamic viscosity to the density of fluid is termed as _____.

Ans

- 1. viscosity ratio
- 2. capillarity
- 3. kinematic viscosity
- 4. surface tension

Question ID : 630680196878

Status : Answered

Chosen Option : 3

Q.26 According to the Ministry of Environment, Forest and Climate Change, Government of India, which of the following classes of water can be used as a drinking water source after conventional treatment and disinfection?

Ans

- 1. Class D
- 2. Class B
- 3. Class A
- 4. Class C

Question ID : 630680196907

Status : Answered

Chosen Option : 4

Q.27 The colour exhibited by colonies of coliform bacteria in MacConkey agar medium is _____.

- Ans
- 1. pink
 - 2. yellow
 - 3. blue
 - 4. green

Question ID : 630680196909
Status : Answered
Chosen Option : 2

Q.28 Calculate the porosity of a soil sample if its void ratio is 0.6.

- Ans
- 1. 28.67%
 - 2. 50.33%
 - 3. 44.25%
 - 4. 37.5%

Question ID : 630680196869
Status : Answered
Chosen Option : 4

Q.29 Which of the following is a part of the plane table survey?

- Ans
- 1. Stadia lens
 - 2. Foot screws
 - 3. Plumbing fork
 - 4. Telescope

Question ID : 630680196846
Status : Answered
Chosen Option : 3

Q.30 As per IS 383:1970, the percentage of fine aggregates (FA) passing through 4.75 mm shall be in the range of _____ for Zone I FA.

- Ans
- 1. 85-100
 - 2. 95-100
 - 3. 75-100
 - 4. 90-100

Question ID : 630680196836
Status : Answered
Chosen Option : 4

Q.31 The following bearings were observed while traversing with a compass. Calculate the corrected bearing of line CB.

Line	Fore bearing	Back bearing
AB	45° 45'	226° 10'
BC	96° 55'	277° 5'
CD	29° 45'	209° 10'
DE	324° 48'	144° 48'

- Ans
- 1. 276° 30'
 - 2. 276° 40'
 - 3. 276° 50'
 - 4. 276° 10'

Question ID : 630680196887
Status : Answered
Chosen Option : 1

Q.32 Brick earth should contain about _____ of silica.

- Ans
- 1. 5%-7%
 - 2. 50%-60%
 - 3. <10%
 - 4. 15%-20%

Question ID : 630680196838
Status : Answered
Chosen Option : 2

Q.33 Which of the following materials possesses a specific gravity value in the range of 0.97 to 1.02?

- Ans
- 1. Pure bitumen
 - 2. Asbestos
 - 3. Ordinary Portland cement
 - 4. Lime

Question ID : 630680196841
Status : Answered
Chosen Option : 1

Q.34 A beam with a triangular cross-section is subjected to a shear force of 15 kN. Calculate the shear stress at the neutral axis of the said section if its base width is 200 mm and height is 300 mm.

- Ans
- 1. 0.667 N/mm²
 - 2. 0.833 N/mm²
 - 3. 0.5 N/mm²
 - 4. 0.750 N/mm²

Question ID : 630680196859
Status : Not Answered
Chosen Option : --

Q.35 An automobile component made of metal with a modulus of elasticity 200 GPa is subjected to a tensile load of magnitude 160 kN as shown in the figure. Determine the total elongation of the component.

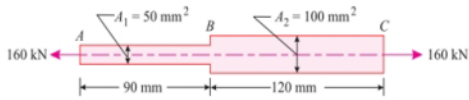

- Ans
- 1. 1.2 mm
 - 2. 2.4 mm
 - 3. 0.6 mm
 - 4. 3.2 mm

Question ID : 630680196857

Status : Not Answered

Chosen Option : --

Q.36 Identify the type of truss shown in the below figure based on the degree of redundancy. Consider that truss is supported with the roller type at A and hinged type at F.

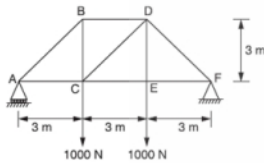

- Ans
- 1. Deficient truss
 - 2. Over rigid truss
 - 3. Redundant truss
 - 4. Perfect truss

Question ID : 630680196892

Status : Answered

Chosen Option : 4

Q.37 Which of the following sewer types has the highest resistance to sulphide corrosion?

- Ans
- 1. Cast iron sewer
 - 2. Reinforced cement concrete sewer
 - 3. Hume steel pipe sewer
 - 4. Vitrified clay sewer

Question ID : 630680196912

Status : Answered

Chosen Option : 1

Q.38 The maximum deflection in a simply supported beam of span ' l ' subjected to a uniformly distributed load with intensity ' w ' kN/m is equal to _____, where ' EI ' is flexural rigidity of the beam and is constant throughout its length.

Ans

1. $\frac{wl^4}{24EI}$

2. $\frac{5wl^4}{384EI}$

3. $\frac{wl^3}{48EI}$

4. $\frac{wl^3}{36EI}$

Question ID : 630680196888

Status : Answered

Chosen Option : 2

Q.39 Identify the INCORRECT statement with respect to the type of buckling of steel columns.

Ans 1.

The flexural buckling is also called as Euler buckling when the plastic behaviour of column occurs.

2.

Compression members with any type of cross-sectional configuration can undergo flexural buckling.

3.

Flexural torsional buckling can occur only with unsymmetrical cross-sections.

4.

Torsional buckling is caused by twisting about the longitudinal axis of the member.

Question ID : 630680196901

Status : Answered

Chosen Option : 3

Q.40 Which of the following is NOT a type of water distribution system for a town?

Ans

1. Grid-Iron system

2. Circular system

3. Dead end system

4. Sprinkler system

Question ID : 630680196910

Status : Answered

Chosen Option : 4

Q.41 Pick the odd one out with respect to the systems of the tacheometric survey.

Ans

1. Subtense method

2. Fixed hair method

3. Tangential method

4. Stadia method

Question ID : 630680196850

Status : Answered

Chosen Option : 3

Q.42 Calculate the combined correction for curvature and refraction to be applied in a survey work (levelling) for a distance of 6000 m.

- Ans**
- 1. 0.72 m
 - 2. 3.24 m
 - 3. 1.45 m
 - 4. 2.42 m

Question ID : 630680196847
Status : Answered
Chosen Option : 2

Q.43 The idea behind the principle of surveying 'working from whole to part' is _____.

- Ans**
- 1. to convert global errors into local errors
 - 2. to fit the map within the page limit
 - 3. to prevent the accumulation of errors and localise them, thus preventing from expanding to greater magnitude
 - 4. to prevent the accumulation of errors and globalise them

Question ID : 630680196843
Status : Answered
Chosen Option : 3

Q.44 The shape of the shear force diagram of a simply supported beam subjected to a uniformly varying load is _____.

- Ans**
- 1. cubic parabolic
 - 2. linear
 - 3. semi-circular
 - 4. parabolic

Question ID : 630680196856
Status : Answered
Chosen Option : 1

Q.45 As per IS 12600:1989, the initial setting time of low heat Portland cement shall NOT be less than _____ minutes.

- Ans**
- 1. 90
 - 2. 45
 - 3. 30
 - 4. 60

Question ID : 630680196860
Status : Answered
Chosen Option : 3

Q.46 Identify the INCORRECT statement with respect to the advantages of the aeration technique used in water treatment.

Ans 1.

It converts iron and manganese from their insoluble state to a soluble state.

2. It decreases the carbon dioxide content of water.

3.

It removes the taste and odour caused by gases due to organic decomposition.

4. It increases the pH value of water.

Question ID : 630680196913

Status : Answered

Chosen Option : 3

Q.47 As per IS-456:2000, the minimum cement content for concrete used in reinforced cement concrete structures exposed to moderate exposure condition is _____. Consider the nominal size of aggregate as 20 mm.

Ans 1. 380 kg/m^3

2. 240 kg/m^3

3. 300 kg/m^3

4. 340 kg/m^3

Question ID : 630680196890

Status : Answered

Chosen Option : 1

Q.48 Identify the correct statement by referring to the cantilever beam shown in the figure.

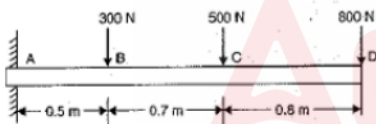

Ans 1. Shear force at point A is lesser than that at point C.

2. Bending moment at point C is lesser than that at point B.

3. Bending moment at point C is less than that at point D.

4. Shear force at point C is greater than that at point B.

Question ID : 630680196854

Status : Not Answered

Chosen Option : --

Q.49 In the given figure, which shows the stable equilibrium for a submerged body?

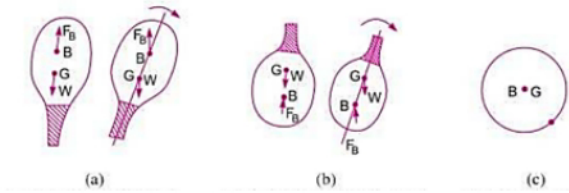

(W' is weight, 'G' is centre of gravity, 'B' is centre of buoyancy, F_B is buoyant force)

- Ans
- 1. Fig.(c) is in stable equilibrium.
 - 2. All are in unstable equilibrium.
 - 3. Fig.(b) is in stable equilibrium.
 - 4. Fig.(a) is in stable equilibrium.

Question ID : 630680196882
 Status : Answered
 Chosen Option : 4

Q.50 Which of the following factors will increase the rate of demand in the consumption of water?

- Ans
- 1. Increased water rates
 - 2. Intermittent supply
 - 3. High pressure in the system
 - 4. Stable community

Question ID : 630680196911
 Status : Answered
 Chosen Option : 3

Q.51 Calculate the moment of inertia of a triangular lamina with respect to its base using the parallel axis theorem. Take the base width as 200 mm and height as 300 mm.

- Ans
- 1. $1.8 \times 10^8 \text{ mm}^4$
 - 2. $4.5 \times 10^8 \text{ mm}^4$
 - 3. $5.3 \times 10^8 \text{ mm}^4$
 - 4. $2.6 \times 10^8 \text{ mm}^4$

Question ID : 630680196858
 Status : Answered
 Chosen Option : 1

Q.52 A soil sample has a bulk unit weight of 20 kN/m^3 and water content of 20%. Calculate its dry unit weight.

- Ans
- 1. 16.67 kN/m^3
 - 2. 21.26 kN/m^3
 - 3. 19.33 kN/m^3
 - 4. 13.33 kN/m^3

Question ID : 630680196870
 Status : Answered
 Chosen Option : 1

Q.53 The liquid limit and plasticity index of a clay sample are 38% and 10%, respectively. Calculate its plastic limit.

- Ans 1. 28%
 2. 18%
 3. 38%
 4. 33%

Question ID : 630680196873
Status : Answered
Chosen Option : 1

Q.54 AS per IS 456:2000, the lap length of steel reinforcement of diameter 20 mm in compression shall NOT be less than _____ if the criteria of the development length in compression is ignored.

- Ans 1. 360 mm
 2. 480 mm
 3. 240 mm
 4. 560 mm

Question ID : 630680196896
Status : Not Answered
Chosen Option : --

Q.55 Which of the following expression is correct to calculate the combined correction for curvature and refraction (C) in levelling? Where, d is the distance sighted measured in km.

- Ans 1. $C = 0.9258d^2$ m
 2. $C = 0.06728d^2$ m
 3. $C = 0.7849d^2$ m
 4. $C = 0.03456d^2$ m

Question ID : 630680196889
Status : Answered
Chosen Option : 2

Q.56 Which of the following is NOT a capping material to cylindrical concrete specimens?

- Ans 1. Cement mortar
 2. Mixture of chloride and inert sand
 3. Mixture of sulphur and fire clay
 4. Neat cement paste

Question ID : 630680196867
Status : Answered
Chosen Option : 2

Q.57 Consider the below statements with respect to water distribution by the grid iron system and identify the correct answer.

Statement A: Water is kept in good circulation due to the absence of dead ends.

Statement B: In the cases of a breakdown in some sections, water is not available from any other section.

- Ans
- 1. Statement A is correct, and statement B is incorrect.
 - 2. Statement B is correct, and statement A is incorrect.
 - 3. Both statements are incorrect.
 - 4. Both statements are correct.

Question ID : 630680196908

Status : Answered

Chosen Option : 3

Q.58 The modular ratio 'm' used in the working stress analysis of reinforced concrete sections is the ratio of _____.

- Ans
- 1. section modulus of concrete to that of steel
 - 2. elastic modulus of concrete to that of steel
 - 3. elastic modulus of steel to that of concrete
 - 4. section modulus of steel to that of concrete

Question ID : 630680196898

Status : Answered

Chosen Option : 2

Q.59 As per IS 800:2007, when transverse stiffeners are NOT provided in a plate girder, the $\frac{d}{t_w}$ ratio of the web connected to flanges along one longitudinal edge only shall be _____, where d = depth of the web, t_w = thickness of the web and ϵ_w = yield stress ratio of the web.

- Ans
- 1. less than or equal to $90\epsilon_w$
 - 2. less than or equal to $250\epsilon_w$
 - 3. less than or equal to $320\epsilon_w$
 - 4. less than or equal to $150\epsilon_w$

Question ID : 630680196905

Status : Not Answered

Chosen Option : --

Q.60 Which of the following factors does NOT influence the maximum size of the aggregate used in making concrete?

- Ans
- 1. Thickness of the structural member
 - 2. Cover thickness to steel reinforcement
 - 3. Spacing of reinforcement
 - 4. Gradation of fine aggregates

Question ID : 630680196863

Status : Answered

Chosen Option : 4

Q.61 Water is flowing through a pipe having diameters 150 mm and 100 mm at the bottom and upper ends, respectively. Calculate the kinetic head of water at the upper end if the flow velocity at the upper end is 0.5 m/s. Consider the acceleration due to gravity to be 10 m/s^2 .

- Ans**
- 1. 50 mm
 - 2. 25 mm
 - 3. 75 mm
 - 4. 12.5 mm

Question ID : 630680196881
Status : Not Answered
Chosen Option : --

Q.62 The particle size distribution curve for soil uses some grading characteristics. Which of the following is NOT among them?

- Ans**
- 1. Uniformity coefficient
 - 2. Coefficient of compressibility
 - 3. Effective size
 - 4. Coefficient of curvature

Question ID : 630680196872
Status : Answered
Chosen Option : 2

Q.63 A rectangular strut with cross-sectional area $30,000 \text{ mm}^2$ is subjected to a point load (120 kN) at an eccentricity 50 mm in a plane bisecting the thickness shown in the figure. Calculate the minimum intensity of stress in the section.

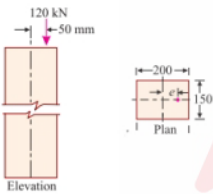

- Ans**
- 1. 3.2 MPa (tensile)
 - 2. 4.0 MPa (tensile)
 - 3. 2.0 MPa (tensile)
 - 4. 1.2 MPa (tensile)

Question ID : 630680196886
Status : Not Answered
Chosen Option : --

Q.64 Which of the following expressions is correct to calculate the polar moment of inertia of a circular section with radius 'R' about its centroid axis?

Ans

✗ 1. $\frac{\pi R^4}{16}$

✗ 2. $\frac{\pi R^4}{12}$

✓ 3. $\frac{\pi R^4}{2}$

✗ 4. $\frac{\pi R^4}{4}$

Question ID : 630680196853

Status : Answered

Chosen Option : 4

Q.65 Identify the correct statement with respect to a Francis turbine.

Ans

✗ 1. A Pelton wheel turbine is a radial flow impulse turbine.

✓ 2.

A Pelton wheel turbine is a tangential flow impulse turbine.

✗ 3. A Pelton wheel turbine is a radial flow reaction turbine.

✗ 4. A Pelton wheel turbine is an axial flow reaction turbine.

Question ID : 630680196885

Status : Answered

Chosen Option : 4

Q.66 Consider the below statements with respect to balanced failure in RCC structures and identify the correct answer.

Statement A: Balanced failure is expected to occur when the compressive strain in the extreme fibre of the concrete reaches the ultimate strain and the tensile strain at the level of centroid of the steel reaches the yield strain.

Statement B: Balanced failure is expected to occur by the simultaneous initiation of crushing of concrete and yielding of steel.

Ans

✓ 1. Both statements are correct.

✗ 2. Both statements are incorrect.

✗ 3. Statement A is correct, and statement B is incorrect.

✗ 4. Statement B is correct, and statement A is incorrect.

Question ID : 630680196894

Status : Answered

Chosen Option : 1

Q.67 Calculate the ratio of Young's modulus of elasticity of material M2 to material M1 based on the given details.

Sl no.	Modulus of rigidity	Poisson's ratio
Material-M1	80 GPa	0.25
Material-M2	100 GPa	0.30

- Ans
- 1. 1.9
 - 2. 0.75
 - 3. 1.6
 - 4. 1.3

Question ID : 630680196852
Status : Not Answered
Chosen Option : --

Q.68 Calculate the pressure at a point that is at 5 m from the free surface of the liquid having a density of $1.5 \times 10^3 \text{ kg/m}^3$. Consider acceleration due to gravity to be 10 m/s^2 .

- Ans
- 1. 75,000 N/m²
 - 2. 750 N/m²
 - 3. 7,50,000 N/m²
 - 4. 7500 N/m²

Question ID : 630680196879
Status : Not Answered
Chosen Option : --

Q.69 Common sugar is an example for _____.

- Ans
- 1. retarding admixture
 - 2. plasticisers
 - 3. super plasticisers
 - 4. accelerating admixture

Question ID : 630680196868
Status : Answered
Chosen Option : 1

Q.70 In a slump cone test, to assess the workability of concrete, the slump mould is filled in ____ layers.

- Ans
- 1. four
 - 2. five
 - 3. three
 - 4. two

Question ID : 630680196864
Status : Answered
Chosen Option : 3

Q.71 Which of the following is NOT a temporary adjustment made in the theodolite survey?

- Ans
- 1. Levelling of the instrument
 - 2. Orienting of the instrument towards magnetic north
 - 3. Set out instrument over the station
 - 4. Parallax elimination

Question ID : 630680196849
Status : Answered
Chosen Option : 4

Q.72 Calculate the coefficient of active earth pressure for a soil mass whose angle of internal friction is found to be 30° .

- Ans
- 1. $\frac{1}{4}$
 - 2. $\frac{1}{5}$
 - 3. $\frac{1}{3}$
 - 4. $\frac{1}{6}$

Question ID : 630680196874
Status : Answered
Chosen Option : 3

Q.73 Identify the type of slab based on the sizes of reinforced cement concrete slabs given below.

Slab₁: $L_y = 6$ m, $L_x = 2.5$ m

Slab₂: $L_y = 4.5$ m, $L_x = 3.2$ m.

L_y is the length of the longer span of the slab and L_x is the length of the shorter span of the slab.

- Ans
- 1. Slab₁-One way
 - 2. Slab₂-One way
 - 3. Slab₁-One way
 - 4. Slab₂-Two way
 - 5. Slab₁-Two way
 - 6. Slab₂-Two way
 - 7. Slab₁-Two way
 - 8. Slab₂-One way

Question ID : 630680196891
Status : Answered
Chosen Option : 4

Q.74 Consider the below statements and identify the correct option with respect to factors affecting the permeability of the soil medium.

Statement A: Permeability is directly proportional to the viscosity of water and inversely proportional to its unit weight.

Statement B: The degree of saturation of the soil medium alters the permeability through soil.

- Ans
- 1. Statement A is correct, and statement B is incorrect.
 - 2. Both statements are incorrect.
 - 3. Statement B is correct, and statement A is incorrect.
 - 4. Both statements are correct.

Question ID : 630680196877
Status : Answered
Chosen Option : 2

Q.75 Consider the below statements with respect to compass surveying and identify the correct answer.

Statement A: A surveyor compass works on the principle of magnetism and used magnetic needle.

Statement B: The sum of included angles in a closed traverse set by a compass is always equal to 360° .

- Ans
- 1. Statement B is correct, and statement A is incorrect.
 - 2. Both statements are correct.
 - 3. Statement A is correct, and statement B is incorrect.
 - 4. Both statements are incorrect.

Question ID : 630680196844
Status : Answered
Chosen Option : 2

Q.76 As per IS 456-2000, the maximum cross-sectional area of tension reinforcement in a reinforced cement concrete beam of size 200×450 mm shall NOT exceed _____. Consider the limit state method.

- Ans
- 1. 1800 mm^2
 - 2. 3600 mm^2
 - 3. 4800 mm^2
 - 4. 2200 mm^2

Question ID : 630680196897
Status : Answered
Chosen Option : 4

Q.77 Convert the direction of a line PQ measured in the quadrantal bearing system $N 25^\circ 30' W$ into the whole circle bearing system.

- Ans
- 1. $25^\circ 30'$
 - 2. $205^\circ 30'$
 - 3. $115^\circ 30'$
 - 4. $334^\circ 30'$

Question ID : 630680196845
Status : Answered
Chosen Option : 4

Q.78 What is the maximum acceptable and permissible (in absence of alternate source) limit of chloride (in mg/l) for drinking water, respectively, as per the latest revised, updated and amended code IS:10500:2012?

- Ans**
- 1. 150 mg/l and 300 mg/l
 - 2. 300 mg/l and 1500 mg/l
 - 3. 250 mg/l and 1000 mg/l
 - 4. 500 mg/l and 1500 mg/l

Question ID : 630680196906
Status : Answered
Chosen Option : 4

Q.79 Consider the below statements with respect to the properties of asbestos and identify the correct answer.

Statement A: Asbestos has low heat conductivity.

Statement B: Asbestos is highly resistant to acids.

- Ans**
- 1. Both statements are incorrect.
 - 2. Statement A is correct, and statement B is incorrect.
 - 3. Both statements are correct.
 - 4. Statement B is correct, and statement A is incorrect.

Question ID : 630680196840
Status : Answered
Chosen Option : 3

Q.80 Consider below statements with respect to methods used to balance a traverse and identify the correct answer.

Statement A: The transit rule may be employed where angular measurements are less precise than the linear measurements.

Statement B: The Bowditch's method assumes that the errors in linear measurements are inversely proportional to the square root of the length of the surveyed line.

- Ans**
- 1. Statement B is correct, and statement A is incorrect.
 - 2. Both statements are correct.
 - 3. Both statements are incorrect.
 - 4. Statement A is correct, and statement B is incorrect.

Question ID : 630680196848
Status : Answered
Chosen Option : 2

Section : Reasoning

Q.1 In a certain code language, 'APPLE' is coded as 'ZKKOV' and 'GRAPE' is coded as 'TIZKV'. How will 'PEARS' be coded in that language?

- Ans**
- 1. KVAIH
 - 2. KVVYJH
 - 3. KVZJH
 - 4. KVZIH

Question ID : 630680196916
Status : Answered
Chosen Option : 4

Q.2 Select the correct mirror image of the given figure when the mirror is placed at the right side.



Ans

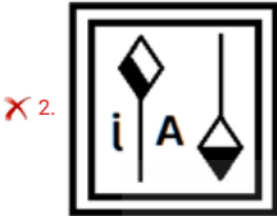
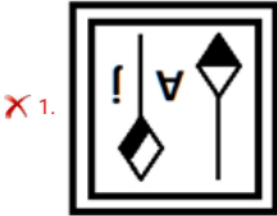

Question ID : 630680196920

Status : Answered

Chosen Option : 3

Q.3 Select the number from among the given options that can replace the question mark (?) in the following series.

500, 379, 330, 305, ?, 292

Ans ✗ 1. 298

✗ 2. 295

✓ 3. 296

✗ 4. 299

Question ID : 630680196921

Status : Answered

Chosen Option : 3

Q.4 A, B, C, D, E, F, G and H are eight members of a family. H is the brother of C. A is C's wife. C is the son-in-law of G. D is the sister of E. G is the son of B. E is the wife of G. B is the wife of F. How is E related to B?

- Ans**
- 1. Husband's sister
 - 2. Brother's daughter
 - 3. Daughter-in-law
 - 4. Daughter

Question ID : 630680196917
Status : Answered
Chosen Option : 3

Q.5 Select correct combination of mathematical signs that can sequentially replace the * signs and balance the given equation.

$$56 * 7 * 2 * 4 * 12 * 8$$

- Ans**
- 1. +, =, ÷, ×, +
 - 2. ÷, ×, +, =, +
 - 3. ÷, ×, =, +, +
 - 4. ÷, ×, -, =, ×

Question ID : 630680196922
Status : Answered
Chosen Option : 2

Q.6 If '×' means 'subtraction', '+' means 'division', '-' means 'addition' and '÷' means 'multiplication', what will be the value of the following expression?

$$30 + \{[(12 - 13) \times (5 + 2)] + (18 \times 13)\}$$

- Ans**
- 1. 15
 - 2. 10
 - 3. 6
 - 4. 3

Question ID : 630680196923
Status : Answered
Chosen Option : 2

Q.7 दिए गए आरेख का ध्यानपूर्वक अध्ययन कीजिए और नीचे दिए गए प्रश्न का उत्तर दीजिए। विभिन्न वर्गों में संख्याएं व्यक्तियों की संख्या दर्शाती हैं।

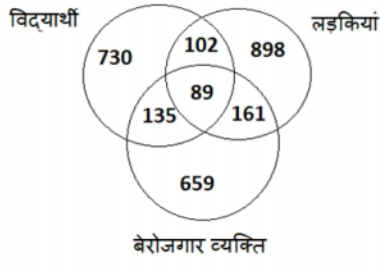

यदि सभी महिला विद्यार्थियों को इंगित करने वाली संख्या को 'A' के रूप में अंकित किया गया है,
यदि सभी नियोजित लड़कियों को इंगित करने वाली संख्या को 'B' के रूप में अंकित किया गया है और
यदि उस संख्या को 'C' के रूप में अंकित किया गया है, जो उन लड़कियों को इंगित करती है जो महिला विद्यार्थी
और बेरोजगार दोनों हैं,
तो नीचे दिए गए समीकरण का उत्तर क्या होगा?

$$A + B - C$$

- Ans
- 1. 1200
 - 2. 974
 - 3. 1000
 - 4. 898

Question ID : 630680196915
Status : Answered
Chosen Option : 3

Q.8 उस विकल्प का चयन करें जो तीसरे पद से उसी प्रकार संबंधित है जिस प्रकार दूसरा पद पहले पद से संबंधित है।

(शब्दों को सार्थक अंग्रेजी शब्द माना जाना चाहिए और शब्द में अक्षरों की संख्या/व्यंजन-संख्या की संख्या के आधार पर एक दूसरे से संबंधित नहीं होना चाहिए।)

कीट (INSECT) : डिम्बक (LARVA) :: तितली (BUTTERFLY) : ?

- Ans
- 1. अश्व-शावक (COLT)
 - 2. इल्ली (CATERPILLAR)
 - 3. मृग-शावक (FAWN)
 - 4. अर्भक (NYMPH)

Question ID : 630680196918
Status : Answered
Chosen Option : 2

Q.9 Select the figure from among the given options that can replace the question mark (?) in the following series.

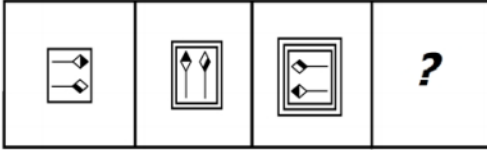

Ans

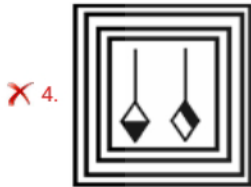
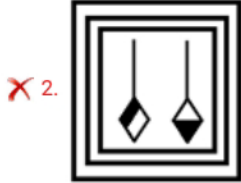
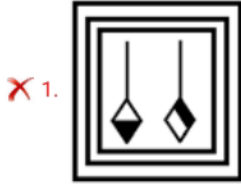

Question ID : 630680196919

Status : Answered

Chosen Option : 3

Q.10 A, B, C, D, E, F, G और H एक वर्गाकार मेज़ के चारों ओर मेज़ के केंद्र की ओर अभिमुख होकर बैठे हैं। उनमें से कुछ लोग कोनों पर बैठे थे, जबकि कुछ लोग भुजाओं के बीचोबीच बैठे थे। A और B कोनों पर थे। G और E विकर्णतः एक दूसरे के सामने थे। F पूर्व की ओर अभिमुख होकर A और E के ठीक बीच में बैठा था। H, F के सामने था। D, B और E के ठीक बीच में था। A के ठीक दाएं कौन बैठा था?

Ans ✓ 1. C

✗ 2. D

✗ 3. H

✗ 4. F

Question ID : 630680196914

Status : Answered

Chosen Option : 4

Section : Quantitative Aptitude

Q.1 21 और 45 के बीच की सम संख्याओं का औसत ज्ञात कीजिए।

- Ans
- 1. 34
 - 2. 33
 - 3. 35
 - 4. 32

Question ID : 630680196926
Status : Answered
Chosen Option : 2

Q.2 एक ट्रेन P, सुबह 6:00 बजे मुंबई से निकलती है और सुबह 9:00 बजे नागपुर पहुँचती है। एक अन्य ट्रेन नागपुर से सुबह 7:00 बजे निकलती है और सुबह 9:00 बजे मुंबई पहुँचती है। दोनों ट्रेनें एक दूसरे को किस समय पार करती हैं?

- Ans
- 1. सुबह 7:54
 - 2. सुबह 8:15
 - 3. सुबह 7:48
 - 4. सुबह 8:12

Question ID : 630680196930
Status : Answered
Chosen Option : 1

Q.3 एक व्यक्ति बाइक द्वारा कुल 270 km की दूरी तय करता है। पहले 4 घंटों में, उसकी चाल 50 km/h रहती है और शेष यात्रा में यह घटकर 35 km/h हो जाती है। बाइक की औसत चाल क्या है?

- Ans
- 1. 39 km/h
 - 2. 45 km/h
 - 3. 38 km/h
 - 4. 42 km/h

Question ID : 630680196927
Status : Answered
Chosen Option : 4

Q.4 The area (in square units) of the triangle formed by the vertices (1, 3), (3, 5) and (5, 2) is:

- Ans
- 1. 4
 - 2. 6
 - 3. 5
 - 4. 7

Question ID : 630680196932
Status : Not Answered
Chosen Option : --

Q.5 A और B एक कार्य को 10 दिनों में कर सकते हैं, जबकि B और C उसी कार्य को 15 दिनों में कर सकते हैं। A, B और C तीनों मिलकर इसे 6 दिनों में समाप्त कर सकते हैं। A और C मिलकर कार्य को कितने दिनों में करेंगे?

- Ans
- 1. 9 दिन
 - 2. 7 दिन
 - 3. 6 दिन
 - 4. 8 दिन

Question ID : 630680196931
Status : Answered
Chosen Option : 1

Q.6 The value of $0.1\bar{7} + 0.1\bar{4} - 0.1\bar{2}$ is:

- Ans
- 1. $\frac{4}{7}$
 - 2. $\frac{1}{5}$
 - 3. $\frac{2}{9}$
 - 4. $\frac{3}{4}$

Question ID : 630680196925
Status : Not Answered
Chosen Option : --

Q.7 पिछले वर्ष पुतिन का वेतन ₹72,400 था और इस वर्ष उसका वेतन ₹81,450 है। पुतिन के वेतन में कितने प्रतिशत की वृद्धि हुई है?

- Ans
- 1. 14.1%
 - 2. 13.3%
 - 3. 11.8%
 - 4. 12.5%

Question ID : 630680196928
Status : Answered
Chosen Option : 4

Q.8 If $3^x \times 9^{15} \times 27^6 = 81^{16}$, then the value of x is:

- Ans
- 1. 12
 - 2. 13
 - 3. 16
 - 4. 15

Question ID : 630680196924
Status : Answered
Chosen Option : 3

Q.9 एक गोले से, जिसका पृष्ठीय क्षेत्रफल 5544 cm^2 है, 0.5 cm त्रिज्या वाली सीसे की कितनी गेंदें बनाई जा सकती हैं?

- Ans
- 1. 75,264
 - 2. 73,584
 - 3. 74,088
 - 4. 76,322

Question ID : 630680196933
Status : Not Answered
Chosen Option : --

Q.10 एक व्यक्ति ने ₹17,30,000 में एक फ्लैट खरीदा। उन्होंने इसकी पेंटिंग और मरम्मत पर ₹40,000 खर्च किए। यदि वह ₹16,10,700 में फ्लैट बेचता है, तो उसकी हानि प्रतिशत क्या है?

- Ans
- 1. 8.3%
 - 2. 9.0%
 - 3. 9.5%
 - 4. 8.8%

Question ID : 630680196929
Status : Answered
Chosen Option : 2

Section : General Awareness

Q.1 भारत के संविधान के अनुच्छेद 129 में _____ के बारे में उल्लेख किया गया है।

- Ans
- 1. सर्वोच्च न्यायालय का मूल अधिकार क्षेत्र
 - 2. सुप्रीम कोर्ट अभिलेखन का न्यायालय होगा
 - 3. कार्यवाहक मुख्य न्यायाधीश की नियुक्ति
 - 4. तदर्थ न्यायाधीशों की नियुक्ति

Question ID : 630680196942
Status : Answered
Chosen Option : 3

Q.2 In which of the following countries was the 12th edition of the IBA Women's World Boxing Championships kick-started?

- Ans
- 1. Russia
 - 2. Turkey
 - 3. India
 - 4. Iran

Question ID : 630680196943
Status : Answered
Chosen Option : 3

Q.3 In which year did the 86th Amendment Act of the Constitution of India come into effect?

- Ans
- 1. 2002
 - 2. 2000
 - 3. 2004
 - 4. 2005

Question ID : 630680196941
Status : Answered
Chosen Option : 1

Q.4 Which of the following payments banks tied up with IndusInd Bank to offer FD facility in April 2022?

- Ans
- 1. Jio Payments Bank
 - 2. Airtel Payments Bank
 - 3. NSDL Payments Bank
 - 4. India Post Payments Bank

Question ID : 630680196938
Status : Answered
Chosen Option : 3

Q.5 In which of the following states is the Bharhut stupa situated?

- Ans
- 1. Uttar Pradesh
 - 2. Andhra Pradesh
 - 3. Himachal Pradesh
 - 4. Madhya Pradesh

Question ID : 630680196936
Status : Answered
Chosen Option : 1

Q.6 Which of the following banks sold quarter of its stock in Ageas Federal Life Insurance in May 2022?

- Ans
- 1. ICICI Bank
 - 2. HDFC Bank
 - 3. Axis Bank
 - 4. IDBI Bank

Question ID : 630680196937
Status : Answered
Chosen Option : 1

Q.7 Which of the following institutes launched the International Monsoons Project Office on the occasion of National Science Day 2022?

- Ans
- 1. IIT Delhi
 - 2. IITM Pune
 - 3. IIT Kanpur
 - 4. IISc Bangalore

Question ID : 630680196934
Status : Answered
Chosen Option : 4

Q.8 The First Anglo-Afghan war took place in:

- Ans
- 1. Afghanistan
 - 2. Sri Lanka
 - 3. India
 - 4. Iran

Question ID : 630680196935
Status : Answered
Chosen Option : 4

Q.9 Vitamin B12 is also known as _____.

- Ans
- 1. biotin
 - 2. thiamine
 - 3. niacin
 - 4. cyanocobalamin

Question ID : 630680196940
Status : Answered
Chosen Option : 2

Q.10 According to India State of Forest Report–2011, approximately how much percentage of forest area do Andaman and Nicobar Islands have?

- Ans
- 1. 88.90%
 - 2. 89.99%
 - 3. 85.95%
 - 4. 86.93%

Question ID : 630680196939
Status : Answered
Chosen Option : 1

Section : English Language

Q.1 Select the most appropriate synonym of the given word to fill in the blank.

COMPASSION

She was filled with _____ when she saw a sick little girl lying under a tree.

- Ans
- 1. sympathy
 - 2. harmony
 - 3. understanding
 - 4. sorrow

Question ID : 630680196946
Status : Answered
Chosen Option : 1

Q.2 Select the most appropriate option to fill in the blank.

The auditorium of the University was full _____ students from different countries.

- Ans
- 1. from
 - 2. with
 - 3. for
 - 4. of

Question ID : 630680196945
Status : Answered
Chosen Option : 1

Q.3 Select the most appropriate meaning of the given idiom.

Lay to rest

- Ans 1. To let a tired person sleep
 2. To bury a dead person
 3. To look after a sick person
 4. To send someone on vacation

Question ID : 630680196949
Status : Answered
Chosen Option : 4

Q.4 The following sentence has been divided into parts. One of them may contain an error. Select the part that contains an error in spelling, from the given options. If you don't find any error, mark 'No error' as your answer.

A quick glance around / the living room revealed / sparckling furniture.

- Ans 1. no error
 2. sparckling furniture.
 3. A quick glance around
 4. the living room revealed

Question ID : 630680196947
Status : Answered
Chosen Option : 4

Q.5 Select the most appropriate meaning of the given idiom.

Go astray

- Ans 1. To travel a long distance
 2. To run away from home
 3. To escape from a situation
 4. To wander off the right path

Question ID : 630680196948
Status : Answered
Chosen Option : 3

Q.6 Select the most appropriate option to fill in the blanks.

Each person taking part in the marathon was provided with _____ t-shirt with _____ logo of the event.

- Ans 1. a; a
 2. a; the
 3. the; a
 4. the; the

Question ID : 630680196944
Status : Answered
Chosen Option : 2

Q.7 Sentences of a paragraph are given below in jumbled order. Arrange the sentences in the correct order to form a meaningful and coherent paragraph.

- A. Metal detectors are useful for finding metal hidden within objects or metal objects buried underground.
- B. Metal detector is an electronic instrument that detects the presence of metals nearby.
- C. If the sensor comes near a piece of metal, this is indicated by a changing tone in earphones or a needle moving on an indicator.
- D. They often consist of a handheld unit with a sensor probe that can be swept over the ground or other objects.

Ans 1. BADC

2. ABCD

3. ADBC

4. BCDA

Question ID : 630680196950

Status : Answered

Chosen Option : 4

Comprehension:

Read the given passage and answer the questions that follow.

Severe malnutrition, also known as severe wasting, is one of the top threats to child survival, yet perhaps one of the least known or understood, according to a report issued on Tuesday by the UN Children's Fund (UNICEF). The report details that around one in five deaths among children under age five can be attributed to severe wasting.

Triggered by a lack of nutritious food and repeated bouts of diseases – such as diarrhoea, measles and malaria – it compromises a child's immunity.

"Young children who have gone without food, rapidly drop a lot of bodyweight, often exacerbated by bouts of infectious diarrhoea, until they become so thin and frail, they look skeletal," UNICEF chief Catherine Russell explained in the report's foreword.

Unlike famine or starvation, relatively few people have heard of severe wasting, although it affects around 13.6 million children globally under the age of five and is one of the leading underlying causes of preventable deaths in young children.

"It is excruciatingly painful for the child whose body is battling the condition. Without lifesaving treatment, it is a battle that many lose," Ms. Russell attested. She also noted that conflicts and climate crises, which destroy access to healthy diets, are "causing that number to rise". But even in stable countries, child wasting has been surging by more than 40%. For example, in Uganda, child wasting has increased 61% since 2016.

"When a baby or child is this underweight and weak, they cannot eat normally," the UNICEF chief explained, meaning that traditional food aid – like bags of wheat or soya – cannot save them. These children need lifesaving, ready-to-use therapeutic food (RUTF), a high-calorie nut paste given as a medical treatment, which can literally mean the difference between life and death.

Despite its simple, affordable effectiveness, amidst a sharp decline in nutrition financing, around 10 million desperate children are not receiving RUTF largely due to the ongoing economic shock of COVID-19.

SubQuestion No : 8

Q.8 Consider the statement 'it compromises a child's immunity'. It means that:

- Ans 1. wasting protects a child's immunity
2. diarrhoea causes wasting in a child
3. measles plays with the child's health
4. wasting endangers a child's resistance

Question ID : 630680196954

Status : Answered

Chosen Option : 2

Comprehension:

Read the given passage and answer the questions that follow.

Severe malnutrition, also known as severe wasting, is one of the top threats to child survival, yet perhaps one of the least known or understood, according to a report issued on Tuesday by the UN Children's Fund (UNICEF). The report details that around one in five deaths among children under age five can be attributed to severe wasting.

Triggered by a lack of nutritious food and repeated bouts of diseases – such as diarrhoea, measles and malaria – it compromises a child's immunity.

"Young children who have gone without food, rapidly drop a lot of bodyweight, often exacerbated by bouts of infectious diarrhoea, until they become so thin and frail, they look skeletal," UNICEF chief Catherine Russell explained in the report's foreword.

Unlike famine or starvation, relatively few people have heard of severe wasting, although it affects around 13.6 million children globally under the age of five and is one of the leading underlying causes of preventable deaths in young children.

"It is excruciatingly painful for the child whose body is battling the condition. Without lifesaving treatment, it is a battle that many lose," Ms. Russell attested. She also noted that conflicts and climate crises, which destroy access to healthy diets, are "causing that number to rise". But even in stable countries, child wasting has been surging by more than 40%. For example, in Uganda, child wasting has increased 61% since 2016.

"When a baby or child is this underweight and weak, they cannot eat normally," the UNICEF chief explained, meaning that traditional food aid – like bags of wheat or soya – cannot save them. These children need lifesaving, ready-to-use therapeutic food (RUTF), a high-calorie nut paste given as a medical treatment, which can literally mean the difference between life and death.

Despite its simple, affordable effectiveness, amidst a sharp decline in nutrition financing, around 10 million desperate children are not receiving RUTF largely due to the ongoing economic shock of COVID-19.

SubQuestion No : 9

Q.9 The central theme of the passage is:

- Ans**
- 1. causes of malnutrition among children
 - 2. UN report on wasting among children
 - 3. severe wasting among young children
 - 4. consequences of wasting among children

Question ID : 630680196952

Status : Answered

Chosen Option : 2

Adda247

ENGINEERS

Comprehension:

Read the given passage and answer the questions that follow.

Severe malnutrition, also known as severe wasting, is one of the top threats to child survival, yet perhaps one of the least known or understood, according to a report issued on Tuesday by the UN Children's Fund (UNICEF). The report details that around one in five deaths among children under age five can be attributed to severe wasting.

Triggered by a lack of nutritious food and repeated bouts of diseases – such as diarrhoea, measles and malaria – it compromises a child's immunity.

"Young children who have gone without food, rapidly drop a lot of bodyweight, often exacerbated by bouts of infectious diarrhoea, until they become so thin and frail, they look skeletal," UNICEF chief Catherine Russell explained in the report's foreword.

Unlike famine or starvation, relatively few people have heard of severe wasting, although it affects around 13.6 million children globally under the age of five and is one of the leading underlying causes of preventable deaths in young children.

"It is excruciatingly painful for the child whose body is battling the condition. Without lifesaving treatment, it is a battle that many lose," Ms. Russell attested. She also noted that conflicts and climate crises, which destroy access to healthy diets, are "causing that number to rise". But even in stable countries, child wasting has been surging by more than 40%. For example, in Uganda, child wasting has increased 61% since 2016.

"When a baby or child is this underweight and weak, they cannot eat normally," the UNICEF chief explained, meaning that traditional food aid – like bags of wheat or soya – cannot save them. These children need lifesaving, ready-to-use therapeutic food (RUTF), a high-calorie nut paste given as a medical treatment, which can literally mean the difference between life and death.

Despite its simple, affordable effectiveness, amidst a sharp decline in nutrition financing, around 10 million desperate children are not receiving RUTF largely due to the ongoing economic shock of COVID-19.

SubQuestion No : 10

Q.10 Consider the statement 'often exacerbated by bouts of infectious diarrhoea'. Here, 'exacerbated' means:

Ans ✓ 1. aggravated

✗ 2. alleviated

✗ 3. improved

✗ 4. irritated

Question ID : 630680196953

Status : Answered

Chosen Option : 3

ENGINEERS